



# **Eos Family**

**(Eos Ti, Eos, Gio, Gio @5, Ion Xe, Ion Xe 20,  
and Element 2)**

## **Operations Manual**

Version 2.9.0

Part Number: 4250M1210-2.9.0 Rev: A

Released: 2019-08

To view a list of ETC trademarks and patents, go to [etcconnect.com/ip](https://etcconnect.com/ip). All other trademarks, both marked and not marked, are the property of their respective owners.

ETC intends this document, whether printed or electronic, to be provided in its entirety.

# Table of Contents

<b>Introduction</b> .....	<b>1</b>
Using this Manual .....	2
Register Your Console .....	2
Online Eos Family User Forums .....	2
Help from ETC Technical Services .....	3
Other Reference Materials .....	3
Important Concepts .....	4
<b>Console Overview</b> .....	<b>11</b>
Eos Ti Geography .....	12
Eos Geography .....	13
Gio Geography .....	14
Gio@5 Geography .....	15
Ion Xe Geography .....	16
Element 2 Geography .....	18
Console Components .....	20
Cleaning Your Console .....	26
Console Capacities .....	26
<b>System Basics</b> .....	<b>29</b>
About System Basics .....	30
The Central Information Area (CIA) .....	30
Browser .....	33
Softkeys .....	35
Displays .....	36
Display Control and Navigation .....	41
Live and Blind Displays .....	48
Playback Status Display .....	60
Using Direct Selects .....	68
Encoders .....	73
Moving Light Controls .....	77
Fader Configuration .....	78
Virtual Keyboard .....	86
sACN Output Viewer .....	86
<b>Managing Show Files</b> .....	<b>89</b>
About Managing Show Files .....	90
Create a New Show File .....	90

Open an Existing Show File .....	90
Merging Show Files .....	93
Printing a Show File .....	95
Saving the Current Show File .....	97
Importing Show Files .....	99
Exporting a Show File .....	101
Exporting Logs .....	101
Deleting a File .....	102
File Manager .....	102
<b>Patch .....</b>	<b>103</b>
About Patch .....	104
Patch Main Displays .....	105
Patching Conventional Fixtures .....	106
Patching Moving Lights, LEDs, and Accessories .....	112
Patching Multicell Fixtures .....	113
Labeling .....	116
Using the Scroller/Wheel Picker and Editor .....	116
Settings in Patch .....	122
Using Device List .....	127
Clearing the Patch .....	133
Update Profile .....	133
Fixture Editor .....	133
<b>Setup .....</b>	<b>149</b>
About Setup .....	150
System .....	150
User .....	159
Device .....	161
Console Status Display .....	166
<b>Basic Manual Control .....</b>	<b>169</b>
About Basic Manual Control .....	170
Using Channel Faders On Element 2 .....	170
Selecting Channels .....	170
Setting Intensity .....	174
Manual Control of Non-intensity Parameters (NPs) .....	175
Home .....	189
Multiple Intensity Channels .....	190
Multicell Fixtures .....	190
Lamp Controls .....	192
Using [+%] and [-%] .....	193
Remainder Dim .....	194

Highlight and Lowlight .....	196
Sneak .....	197
Select Keys .....	198
Channel Check .....	200
Address at Level .....	200
Address Check .....	200
Flash .....	200
<b>Using Groups .....</b>	<b>203</b>
About Groups .....	204
Recording Groups Live .....	204
Selecting Groups .....	208
Opening the Group List .....	208
Using Groups as a Channel Collector .....	209
<b>Using Fan .....</b>	<b>211</b>
About Fan .....	212
Fanning Parameter Data .....	212
Fan From the Command Line .....	212
Fanning References .....	213
Fanning Timing and Delays .....	213
Using Subgroups with Fan .....	213
<b>Using Mark .....</b>	<b>215</b>
About Mark .....	216
AutoMark .....	216
Referenced Marks .....	217
<b>Storing and Using Palettes .....</b>	<b>223</b>
About Palettes .....	224
Palette Types .....	224
Palette Options .....	225
Storing Palettes Live .....	225
Recalling Palettes .....	228
Editing Palettes Live .....	229
Editing Palettes in Blind .....	230
Using By Type Palettes .....	233
Removing Channels from a Palette .....	234
Deleting Palettes .....	234

<b>Storing and Using Presets .....</b>	<b>235</b>
About Presets .....	236
Preset Options .....	236
Storing Presets Live .....	236
Recalling Presets .....	238
Effects In Presets .....	238
Editing Presets Live .....	239
Using the Preset List .....	239
Editing Presets in Blind .....	240
Using By Type Presets .....	242
Removing Channels From a Preset .....	243
Deleting Presets .....	243
Presets and Palettes Fader Properties .....	244
<b>Working with a Single Cue List .....</b>	<b>249</b>
About Single Cue List .....	250
Basic Cueing .....	250
Recording Cues in Live .....	250
Using [Cue Only / Track] .....	252
Selective Storing Cues in Live .....	253
Timing .....	254
Assigning Cue Attributes .....	257
Flags .....	263
Using External Links .....	265
Modifying Cues Live .....	266
[Update] .....	267
Recording and Editing Cues from Blind .....	271
Deleting Cues .....	274
Using The Cue List Index .....	275
<b>Using Filters .....</b>	<b>283</b>
About Filters .....	284
Record Filters .....	284
Partial Filters .....	284
Clearing Filters .....	285
Storing Data with Record Filters .....	285
<b>Working with Multiple Cue Lists .....</b>	<b>287</b>
About Working With Multiple Cue Lists .....	288
Recording to a New Cue List .....	288
Using [Go To Cue] with Multiple Cue Lists .....	291

<b>Advanced Manual Control .....</b>	<b>293</b>
About Advanced Manual Control .....	294
Using [Copy To] .....	294
Using [Recall From] .....	295
Using {Make Null} .....	297
Using {Make Manual} .....	298
Using {Make Absolute} .....	299
Using [Capture] .....	299
Using [Query] .....	300
Using [Undo] .....	301
<b>Cue Playback .....</b>	<b>303</b>
About Cue Playback .....	304
Playback Controls .....	305
Selected Cue .....	305
Out-of-Sequence Cues .....	306
Virtual Faders .....	309
Assigning Faders .....	309
Displaying Fader Pages With Content .....	310
Changing Fader Pages .....	310
Playback Fader Controls .....	310
<b>Multipart Cues .....</b>	<b>317</b>
About Multipart Cues .....	318
Record a Multipart Cue in Live .....	318
Storing a Multipart Cue in Blind .....	320
Deleting a Part from a Multipart Cue .....	321
<b>Creating and Using Effects .....</b>	<b>323</b>
About Effects .....	324
The Effect List .....	324
Effects Editor .....	325
Effect Status Display .....	329
Effect Channel Display .....	331
Step Effects .....	332
Absolute Effects .....	335
Effect Background Value Modification .....	338
Beats Per Minute .....	338
Multiple Intensity HTP Effects .....	340
Relative Effects .....	340
Preprogrammed Rainbow Effects .....	342

Apply an Existing Effect .....	343
Editing Effects Live .....	343
Stop an Effect .....	343
Query and Group Effect .....	344
Using Offset .....	344
Replace With .....	344
Deleting an Effect .....	344
Recording an Effect to a Preset .....	344
Recording an Effect in a Cue .....	345
Effects on Faders .....	345
Delaying Effects .....	347

## Using Park ..... 349

About Park .....	350
Park Display .....	350
Parked Values in Live .....	350
Parked Addresses in Live .....	351
Park Values from the Park Display .....	351

## Storing and Using Submasters ..... 353

About Submasters .....	354
Paging Submasters .....	354
Recording a Submaster .....	354
Submaster List .....	355
Submaster Properties .....	355
Submaster Information .....	360
Labeling a Submaster .....	361
Loading Submasters .....	361
Using Bump Button Timing With Submasters .....	361
Execute List .....	362
Freeze and StopEffect on Submasters .....	362
Moving and Copying Submasters .....	363
Releasing Content From a Submaster .....	363
Updating a Submaster .....	364
Deleting a Submaster .....	364

## Using About ..... 365

About [About] .....	366
[About] .....	367
{What's New} .....	367
[About] System .....	368
[About] Channel .....	369
[About] Address .....	371



[About] Cuelist .....	373
[About] Cue .....	373
[About] Curves .....	374
[About] Effects .....	374
[About] Groups .....	374
[About] Submaster .....	374
[About] Macro .....	375
[About] IFCB Palettes .....	375
[About] Presets .....	375
[About] Color Path .....	375
[About] Live .....	376

## Storing and Using Curves ..... 377

About Curves .....	378
Creating a Curve .....	379
Editing Curves .....	379
Applying a Curve To Channels In Patch .....	380
Curves Applied to Cues .....	380
Applying a Curve To Scroller Fans .....	381
Delete a Curve .....	381

## Storing and Using Snapshots ..... 383

About Snapshots .....	384
Recording Snapshots .....	384
Recalling Snapshots .....	386
Editing Snapshots .....	386
Deleting Snapshots .....	387

## Storing and Using Macros ..... 389

About Macros .....	390
Store a Macro from Live .....	390
Using the [Learn] key .....	390
Macro Editor Display .....	391
Create a New Macro from the Display .....	393
Edit an Existing Macro .....	393
Play a Macro .....	394
Stop a Macro .....	395
Delete a Macro .....	395

## Using Magic Sheets ..... 397

About Magic Sheets .....	398
Magic Sheet Browser .....	398

Navigating a Magic Sheet .....	401
Creating and Editing Magic Sheets .....	402
Limited Expand Mode .....	417
Examples of Magic Sheets .....	418
<b>Virtual Media Server .....</b>	<b>421</b>
About Virtual Media Server .....	422
Media Content .....	422
Exporting Media Content .....	423
Patching the Virtual Media Server and Layers .....	424
Creating a Pixel Map .....	424
Working with the Virtual Media Server .....	426
Effect Layers .....	432
Pixel Mapping in a Multi-Console System .....	434
<b>Using Partitioned Control .....</b>	<b>437</b>
About Partitioned Control .....	438
How to Use Partitions .....	438
Setting Up Partitioned Control .....	438
Partition List .....	438
Creating New Partitions .....	438
Deleting Partitions .....	439
Using Partitions .....	439
Partitions in Playback .....	439
Partitions on Cue Lists .....	439
Flexichannel in Partitioned Control .....	440
<b>Multi-console and Synchronized Backup .....</b>	<b>441</b>
Overview .....	442
Multi-console Setup .....	442
Synchronized Backup .....	446
Mirror Mode .....	448
<b>Eos Configuration Utility .....</b>	<b>451</b>
Overview .....	452
Eos Configuration Utility Reference .....	452
General Settings .....	453
Network Settings .....	459
Maintenance .....	467
Buttons .....	472
RFR .....	472

<b>Show Control</b> .....	<b>475</b>
About Eos Family Show Control .....	476
Show Control Settings .....	477
Show Control Display .....	484
Time Code .....	487
Real Time Clock (RTC) .....	491
Analog Inputs .....	493
sACN Input .....	497
MIDI Show Control .....	499
String Interface .....	504
MIDI Raw .....	511
Open Sound Control (OSC) .....	519
Eos Family Show Control Capabilities .....	541
Advanced OSC .....	543
Eos OSC Keys .....	559
<b>Facepanel Shortcuts</b> .....	<b>585</b>
<b>Eos Family Hotkeys</b> .....	<b>588</b>



# Introduction

---

Using this Manual .....	2
Register Your Console .....	2
Online Eos Family User Forums .....	2
Help from ETC Technical Services .....	3
Other Reference Materials .....	3
Important Concepts .....	4

## Using this Manual

This manual is for use with the Eos Titanium, Eos, Gio, Gio @ 5, Ion Xe, Ion Xe 20, Element 2, Eos RPU, Ion Xe RPU, and ETCnomad Puck control systems. For topics that apply to all of the platforms, Eos will be used. When a topic pertains to specific consoles, their names will be used.

In order to be specific about where features and commands are found, the following naming and text conventions will be used:

- Browser menus and commands are indicated in **bold text**. For example: In the **File** menu, click **Open**.
- Alphanumeric keyboard buttons are indicated in all CAPS. For example, ALT or CTRL.
- Facepanel buttons are indicated in bold **[brackets]**. For example, **[Live]** or **[Enter]**. Optional keys are indicated in **<angle brackets>**, for example, **<Cue>** or **<Sub>**.
- Keys which are intended to be pressed or held simultaneously are indicated with the "and" symbol. For example, **[Load] & [Timing Disable]**.
- Softkeys and direct selects are indicated in bold **{braces}**. A note about **<More SK>** (more softkeys): this command is always indicated as optional, and is only indicated once in an instruction regardless of how many pages of softkeys exist. This is because there is no way to predict what softkey page you are on at any given time. Press **More Softkeys** until you find the required command.
- References to other parts of the manual are indicated in underlined blue (for example, [Introduction \(on the previous page\)](#)). When viewing this manual electronically, click on the reference to jump to that section of the manual.



**Note:** Notes are helpful hints and information that is supplemental to the main text.

---



**CAUTION:** A Caution statement indicates situations where there may be undefined or unwanted consequences of an action, potential for data loss or an equipment problem.

---



**WARNING:** A Warning statement indicates situations where damage may occur, people may be harmed, or there are serious or dangerous consequences of an action.

---

Please email comments about this manual to: [TechComm@etconnect.com](mailto:TechComm@etconnect.com)

## Register Your Console

Registering your console with ETC ensures that you will be notified of software and library updates, as well as any product advisories.

To register your console, you will need to enroll in "My ETC," a personalized ETC website that provides a more direct path of communication between you and ETC.

Register now at <http://etconnect.com/product.registration.aspx>.

## Online Eos Family User Forums

You are encouraged to visit and participate in the ETC Eos Family User Forum, accessible from the ETC website ([etconnect.com](http://etconnect.com)). This gives you access to an online community of Eos Family users where you can read about other users' experiences, suggestions, and questions regarding the product as well as submit your own.

To register for the ETC Family User Forum:

1. Go to ETC’s community website ([community.etconnect.com](http://community.etconnect.com)).
2. You may register for the forum by clicking the “join” link in the upper right corner of the page.
3. Follow the registration instructions provided by the community page.

## Help from ETC Technical Services

If you are having difficulties, and your problem is not addressed by this document, try the ETC support website at [support.etconnect.com](http://support.etconnect.com) or the main ETC website at [etconnect.com](http://etconnect.com). If none of these resources are sufficient, contact ETC Technical Services directly at one of the offices identified below. Emergency service is available from all ETC offices outside of normal business hours.

When calling for help, take these steps first:

- Prepare a detailed description of the problem
- Go near the equipment for troubleshooting
- Find your notification number if you have called in previously

### Americas

Electronic Theatre Controls Inc.  
Technical Services Department  
3031 Pleasant View Road  
Middleton, WI 53562  
800-775-4382 (USA, toll-free)  
+1-608 831-4116  
[service@etconnect.com](mailto:service@etconnect.com)

### United Kingdom

Electronic Theatre Controls Ltd.  
Technical Services Department  
26-28 Victoria Industrial Estate  
Victoria Road,  
London W3 6UU England  
+44 (0)20 8896 1000  
[techservltd@etconnect.com](mailto:techservltd@etconnect.com)

### Asia

Electronic Theatre Controls Asia, Ltd.  
Technical Services Department  
Room 1801, 18/F  
Tower 1, Phase 1 Enterprise Square  
9 Sheung Yuet Road  
Kowloon Bay, Kowloon, Hong Kong  
+852 2799 1220  
[techservasia@etcasia.com](mailto:techservasia@etcasia.com)

### Germany

Electronic Theatre Controls GmbH  
Technical Services Department  
Ohmstrasse 3  
83607 Holzkirchen, Germany  
+49 (80 24) 47 00-0  
[techserv-hoki@etconnect.com](mailto:techserv-hoki@etconnect.com)

### France

ETC France  
62-64 rue Danielle  
Casanova  
Saint-Denis Cedex,  
F93200  
+33 1 4243 3535  
[techservltd@etconnect.com](mailto:techservltd@etconnect.com)

## Other Reference Materials

### Help System

A key help system is contained within your system. To access help, press and hold **[Help]** and press any key to see:

- the name of the key
- a description of what the key enables you to do
- syntax examples for using the key (if applicable)
- links to topics in the manual



**Note:** Key help is included on most tangible action buttons on your Eos console. This includes most softkeys and touchbuttons as well as the traditional keys on the keypad.

---



**Note:** As with hard keys, the “press and hold **[Help]**” action can be used with softkeys and touchbuttons as well.

---

## Show Control Resources

The chapter on show control in this manual is intended to provide basic information specific to the Eos Family show control system. You may want to explore additional resources to learn more about show control.

The following resources are recommended:

- John Huntington, Show Networks and Control Systems, (Brooklyn, NY:Zircon Designs Press, 2012)
- The ETC Support Articles: <https://support.etcconnect.com/ETC>

## Important Concepts

Before using your console, you should read and familiarize yourself with the concepts defined below. These concepts are important for understanding both how Eos functions as well as how you, as a programmer, will interact with your system to produce a successful show.

- [Channel](#)
- [Address](#)
- [Record Targets](#)
- [Cues](#)
- [Cue List Ownership](#)
- [Syntax Structure](#)
- [Parameters and Parameter Categories](#)
- [Tracking vs. Cue Only](#)
- [Move Instruction](#)
- [Manual Data](#)
- [Move Fade](#)
- [Block vs. Assert](#)
- [Live and Blind](#)
- [HTP vs. LTP](#)

## Channel

A channel is a single numerical name that is used by Eos to control a dimmer, a group of dimmers, a dimmer and a device, or a complete moving light fixture.

### **Channel = Fixture**

A fixture is defined as a group of related addresses that together control a device. An example of a fixture would be an ETC Revolution. This moving light contains 31 parameters that together allow you to perform various functions such as pan and tilt. Each of these attributes is addressed by a different output.



Eos treats fixtures and channels as one and the same. Unlike former ETC consoles where a fixture occupied one channel for each parameter, Eos assigns each fixture a single channel number. Individual parameters are then associated with that channel as additional lines of channel information.

When you select a channel number, all of the controllable properties or parameters of that channel are available through the keypad, level wheel, or the encoders.



**Note:** *Multicell fixtures are handled differently. They are fixtures made up of multiple channels and addresses. See [Patching Multicell Fixtures \(on page 113\)](#) and [Multicell Fixtures \(on page 190\)](#) for more information.*

---

## Address

Addresses are numerical identifiers set on the actual dimmers, moving light fixtures, or other devices you want to control. To connect addresses to channels, you will need to use the Patch function of Eos. For more information, [About Patch \(on page 104\)](#).



**Note:** *You can patch more than one address to a single channel, but you cannot patch multiple channels to a single address.*

---

## Syntax Structure

Most instructions can be entered into Eos through the command line. The command line expects instructions to be entered in a specific structure, or syntax.

Generally speaking, the order of syntax can be described as:

- What are you trying to affect? (Channel, group)
- What do you want it to do? (Change intensity, focus, pan/tilt)
- What value do you want? (Intensity at full, Iris at 50)

Naturally other commands will be used in the course of programming your show, but most other functions are modifiers of these three basic steps: modifying the channel(s) you are working with, determining what parameters of those channels you are impacting, and what value you want them to assume. When working with [Record Targets \(on the next page\)](#), the syntax is similar.



**Note:** *Not all actions must be entered from the command line, although many will result in a command line instruction. Other actions bypass the command line entirely.*

---

## Enter

Since the command line can receive multiple edits and instructions at once, it is necessary to let Eos know when you have completed your instruction in the command line. This is done with the **[Enter]** key.

There are some commands which are self-terminating, and therefore do not require **[Enter]** to be pressed. Some (but not all) of these commands are:

- Out
- +%
- -%
- Level
- Actions from the direct selects

## Parameters and Parameter Categories

Eos divides fixture parameters into four major **parameter categories**: Intensity, Focus, Color, and Beam.

These are the parameters in each category:

- **Intensity**- Intensity
- **Focus** - Pan and Tilt
- **Color** - All color parameters (such as color wheel, CMY, scrollers, and so on).
- **Beam** - Any parameter not covered in the other categories.



**Note:** *Throughout this manual, non-intensity parameters will be referred to as NPs.*

---

## Record Targets

A record target is any data location that you can store data using a **[Record]** command. Examples of record targets are cues, palettes, and macros.

## Cues

A cue is a record target comprised of channels with associated parameter data, discrete (channel/parameter level) timing, cue timing, and cue attributes (such as preheat, follow or hang instructions).

## Tracking vs. Cue Only

Eos is, by default, a tracking console. This means two things. First, tracking relates to how cue lists are created. Once data is in a cue list, it will remain a part of that cue list, at its original setting, until a new instruction is provided or until it is removed from the cue list using filters or null commands.

Secondly, tracking relates to how changes to cue data are handled. Unless otherwise instructed by a Cue Only command, changes to a parameter in a cue will track forward through the cue list until a move instruction (or block command) is encountered.

It is possible to change the default setting of Eos to “Cue Only” in [About Setup \(on page 150\)](#). This prevents changes from tracking forward into subsequent cues, unless overridden with a track instruction. See [Track \(on page 159\)](#) for more information.

Eos also has a **[Cue Only/Track]** button that allows you to record or update a cue as an exception to the default setting. Therefore, if the console is set to Tracking, the button acts as Cue Only. If console is set to Cue Only, it behaves as a Track button.

## Tracking Mode

When you create a new cue, any unchanged channel parameter data from the previous cue is tracked into the new specified cue. Any changes in this new cue will also track forward into subsequent cues until a move instruction or a block flag is encountered. In the example below, the gray boxes indicate tracked values and the white boxes indicate move instructions.

Channels	1	2	3	4	5
Cue 1	00	25	00	FL	30
Cue 2	FL	25	60	FL	25
Cue 3	FL	25	50	FL	50
Cue 4	FL	25	50	FL	30
Cue 5	00	25	50	00	65

When in tracking mode, edits made to an existing cue will track forward through the cue list until a move instruction is encountered. Changes made to Cue 3 will affect the cue list as shown below in bold.

Channels	1	2	3	4	5
Cue 1	00	25	00	FL	30
Cue 2	FL	25	60	FL	25
<b>Cue 3</b>	<b>50</b>	<b>75</b>	<b>75</b>	<b>80</b>	<b>65</b>
Cue 4	50	75	75	80	30
Cue 5	00	75	75	00	65

### **Cue Only Mode**

The [Cue Only/Track] key is an exception to this behavior. [Cue Only/Track] button combined with [Record] or [Update] modifies standard tracking behavior. When you record a cue in the middle of the cue list, using the [Q Only] button will prohibit new information from tracking into the subsequent cue, and will protect the previously tracking levels by adding a move instruction into the next cue for those levels. When you rerecord or update a cue, the modifications will not track forward. Using [Record] <Cue> [3] [Q Only] [Enter] would affect the cue list as shown below.

Channels	1	2	3	4	5
Cue 1	00	25	00	FL	30
Cue 2	FL	25	60	FL	25
<b>Cue 3</b>	<b>50</b>	<b>75</b>	<b>75</b>	<b>80</b>	<b>65</b>
Cue 4	FL	25	50	FL	30
Cue 5	00	25	50	00	65

### **Using Trace**

{Trace} works just like Tracking mode, except it allows changes to be tracked backwards through the cue list, until it sees a move instruction. In the example below, the channel levels have been adjusted while cue 3 is live on stage. Using Trace will take those adjusted levels and update them into the cues as follows: channel 1's new level is recorded into cue 2, channel 2's level is recorded into cue 1, and channel 3's level is recorded into cue 3. This is because the move instruction for those channels are contained in those cues. In the case of channels 1 and 2, their new level will track into cue 3. Using [Record] <Cue> [3] {Trace} [Enter] would affect the cue list as shown below in bold.

Channels	1	2	3	4	5
Cue 1	00	75	00	80	30
Cue 2	50	75	60	80	25
<b>Cue 3</b>	50	75	<b>75</b>	80	<b>65</b>
Cue 4	FL	75	50	FL	30
Cue 5	00	75	50	00	65

To force that channel's new value to go backward in the cue list, **{Trace} {Trace}** can be used.

For information on using **[Update]** and **{Trace}**, See [Using Trace \(on page 270\)](#).

## Move Instruction

A move instruction is any change to a parameter from its previous stored value. A change to a channel's intensity is a move instruction. A change to a channel's pan or tilt is a move instruction. A change to a channel's color mixing is a move instruction, and so on.

## Manual Data

Manual data is any value set for a channel via the command line. Manual data will remain at its value until a move instruction is provided for it.

## Move Fade

Move Fade is a lighting control philosophy which determines how cues are played back. Eos adheres to this philosophy.

In a Move Fade system, parameters do not change from their current setting until they are provided a move instruction in a cue or are given a new instruction manually.

### Example:

In cue 1, channel 1 has been given an intensity value of 50%. This value does not change until cue 20, where channel 1 is moved to 100%. Therefore, channel 1 has a tracked intensity value of 50% in cues 2-19. If the user applies a manual intensity value of 25% while sitting in cue 5 (for example), that channel will stay at 25% until Cue 20 is recalled - because 20 is the next cue in which channel 1 has a move instruction.

## Cue List Ownership



**Note:** Multiple cue lists are not available on Element 2.

Eos is capable of running multiple cue lists. Cue list ownership is determined by the cue from which a channel is currently receiving its value. In Live, a parameter is considered to be "owned" by a cue list when it is receiving its current value from that cue list.

When alternating between cue lists in sequential playback, an active cue list does not necessarily own a channel unless that list has provided the last move instruction for that channel. For example, assume a channel is owned by cue list 1 and is at a tracked value. If a cue from another cue list is executed and provides a move instruction for the channel in the new cue, the channel is now owned by the second cue list. It will not return to cue list 1 until that cue list provides a move instruction for the channel.

Assert may be used to override this default behavior, allowing a cue list's control over a channel to resume, even when the channel's data is tracked.

This rule is not followed when executing an out-of-sequence cue. An out-of-sequence cue is any cue that is recalled via **[Go To Cue]**, a Link instruction, or manually changing the pending cue. In general applications, the entire contents of the cue (both moves and tracks) will be asserted on an out-of-sequence cue.

## Block vs. Assert

In previous ETC consoles, placing a block instruction on a channel was a way to treat a tracked value as a move instruction, both in editing and playback. In Eos, this behavior is now split up. Blocked channel data is an editing convention only, and it prohibits tracked instructions from modifying the associated data. Blocked data has no impact on playback; the channels will continue to play back as though they were tracks. Assert is used to force playback of a tracked/ blocked value.

Assert is not available on Element 2.

## Live and Blind

Live and Blind are methods to view and edit data in your show files. When you press the **[Live]** key, the screen will show you the live display. When you press **[Blind]**, you will see the blind display. In either case, you may use the **[Format]** key to alter how the data is displayed (see [Using \[Format\] \(on page 48\)](#)).

When in Live, the data displayed represents the data being sent from the console at that moment. In other words, the parameter data that is “live” on stage. When you edit data in live, those changes will become active and visible on stage as soon as the command line is terminated, unless auto playback has been disabled in Setup. See [Auto Playback \(on page 159\)](#) for more information.

When in Blind, the data displayed represents data from the record target you choose to view (cues, presets, palettes, and so on). When you edit data in Blind, changes will not automatically appear on stage, since the data you are modifying is not live. This is true even if the record target you are modifying is active on stage. It is possible to play a cue in Live, then switch to Blind and edit that cue in blind without affecting levels on stage. Edits in Blind do not require a **[Record]** command to be stored. They are considered stored when the command line is terminated. Any display that is not the Live display is considered Blind, and the Blind LED will be illuminated. For example, if you open patch, the blue LED on **[Blind]** will be lit to show that you are in a Blind display.

## HTP vs. LTP

HTP (Highest-Takes-Precedence) and LTP (Latest-Takes-Precedence) are terms used to define the output of a channel parameter that is receiving data from multiple sources. In HTP, the highest level of all sources will be executed. In LTP, the most recent level received will be executed. Cue lists can operate as HTP or LTP for intensity parameters only. Non-intensity parameters (NPs) are always LTP. Submasters can operate as HTP or LTP for intensity. The default is HTP. Eos’s default cue list setting for intensity is LTP.

### **HTP**

HTP is only applicable to the intensity of a channel. HTP channels will output the level that is the highest of all inputs. HTP channels are also referred to as “pile-on”, because as control inputs are added (for example - you may bring up cues and multiple submasters that all have the same channel recorded at various levels), the system calculates which input has the highest level for that channel and outputs that level for the channel. As control inputs are removed (you pull some of the submasters down to zero), the console will adjust the channel level, if required, to the highest remaining level.

## ***LTP***

LTP is applicable to any parameter of any channel. LTP output is based on the most recent move instruction issued to the channel parameter. Any new values sent to the channel will supersede any previous values, regardless of the level supplied.

Eos determines the LTP value for a channel, which is overridden by any HTP input values that are higher than the LTP instruction. This is then finally modified by manual control.

# Chapter 1

## Console Overview

---

Inside this section you will find general descriptions of your console and various areas of the user interface.

Eos Ti Geography .....	12
Eos Geography .....	13
Gio Geography .....	14
Gio@5 Geography .....	15
Ion Xe Geography .....	16
Element 2 Geography .....	18
Console Components .....	20
Cleaning Your Console .....	26
Console Capacities .....	26

## Eos Ti Geography

Below is a diagram of Eos Ti with references made to specific areas of use. The terms and names for each area and interface are used throughout this manual.

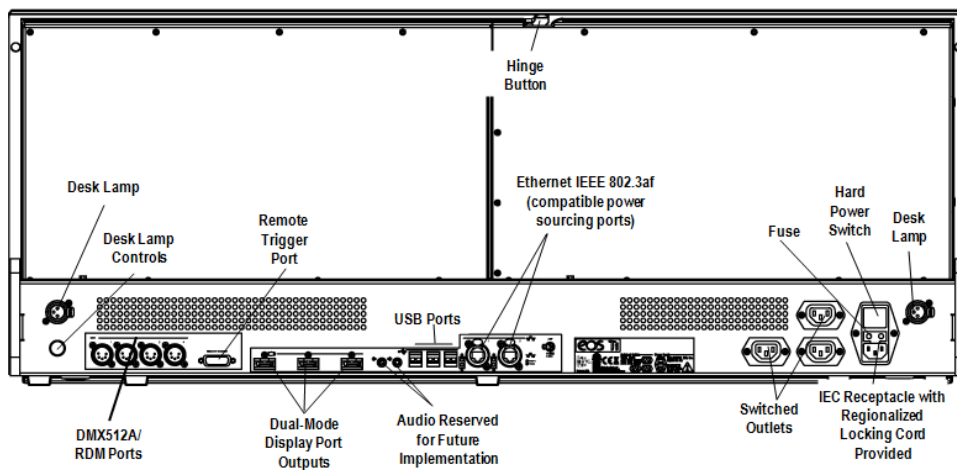
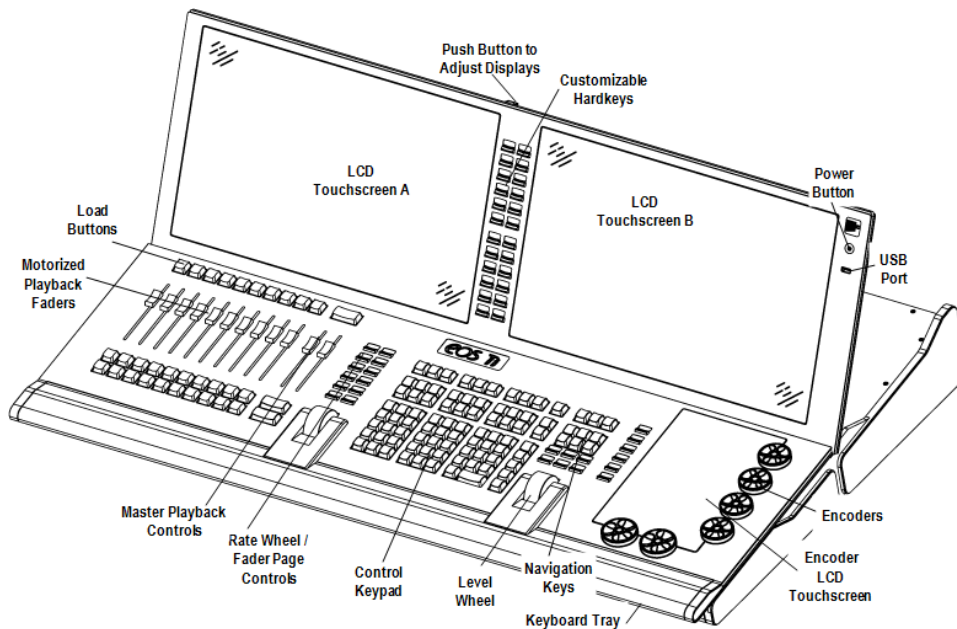

## Eos Ti Fuse Replacement



**CAUTION:** For continued protection against risk of fire, replace only with same type and rating of fuse.



**ATTENTION :** Pour ne pas compromettre la protection contre les risques d'incendie, remplacer par un fusible de même type et de mêmes caractéristiques nominales.



Fuse replacement information and additional electrical ratings can be found on this label located on Eos Ti's rear panel.

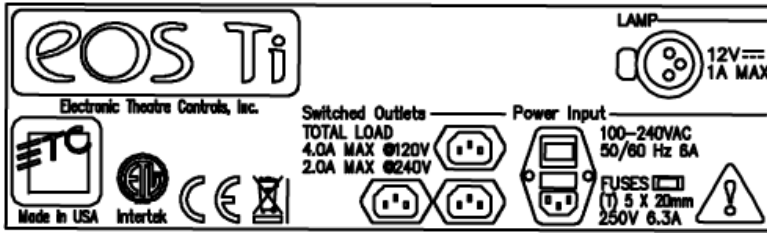

## Eos Geography

Below is a diagram of Eos with references made to specific areas of use. The terms and names for each area and interface are used throughout this manual.

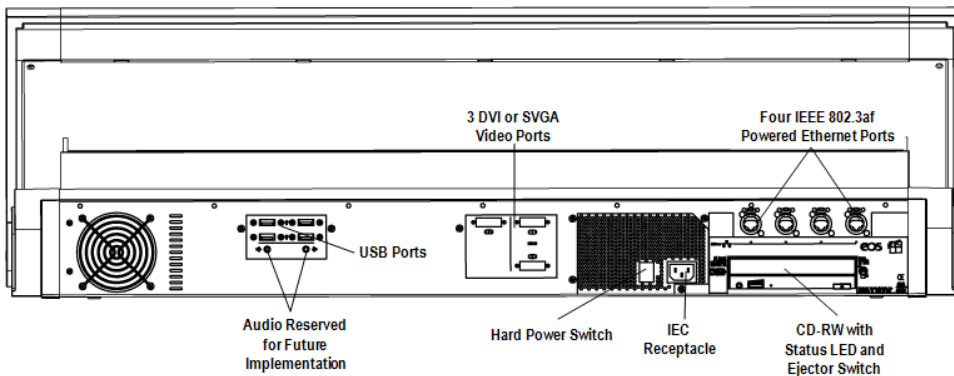
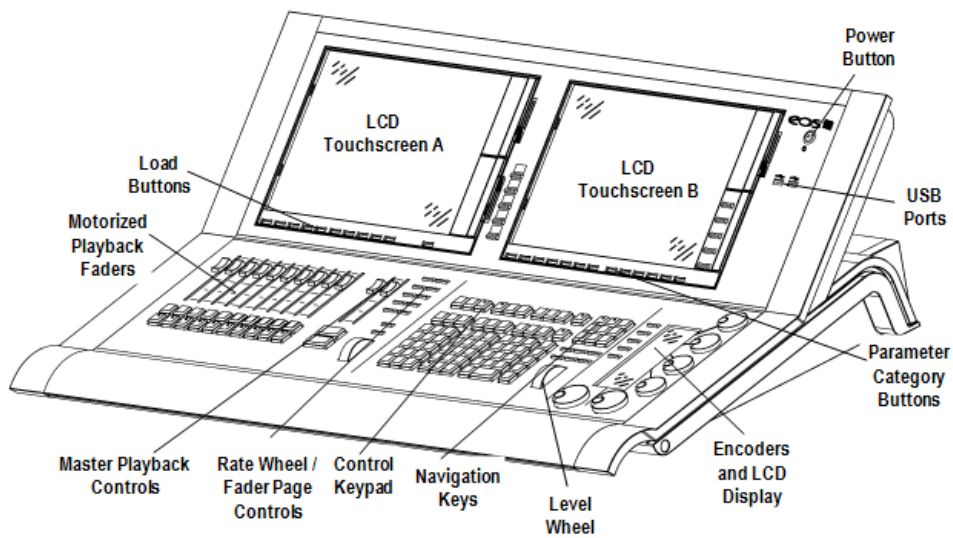

## Eos Button Modules



**Note:** Button modules are only for use with Eos consoles.

The Eos button modules provide the ability for multiple simultaneous button presses with tactile feedback. The displays and text above each button change to reflect the current mapping of the button.



Button modules are available in a 50 button array for use with the direct selects. Button modules provide you with tactile feedback of each button press. The module is transparent allowing the text and graphics from the LCD to repaint each button. Up to three button modules may be installed on the console, two on LCD A and one on the top of LCD B, above the CIA.

LCD A (see [Eos Geography \(on the previous page\)](#)) may be split into numerous sections using Eos button modules and customized views. The top portion of LCD B is also user-configurable while the bottom portion is reserved for the CIA.

Button modules are optional and therefore not required for operation.

### ***Installing Button Modules***

Should you desire to use the button modules over your direct selects, follow the instructions below to install them.

It is recommended that you install the button modules with the console power off.

1. Place the left end of a button module in place over touchscreen area 1, 2, or 3. Align the corner of the button module with the corner of the recessed touchscreen area.
2. Lay the right end of the button module in place and gently press until it is flush with the front of the console. The direct selects will automatically appear once it is installed and the console is powered up.
3. To remove the module, slide the release latch (located to the right of the respective module) upwards and pull the module out from right to left.

## **Gio Geography**

Below is a diagram of Gio with references made to specific areas of use. The terms and names for each area and interface are used throughout this manual.

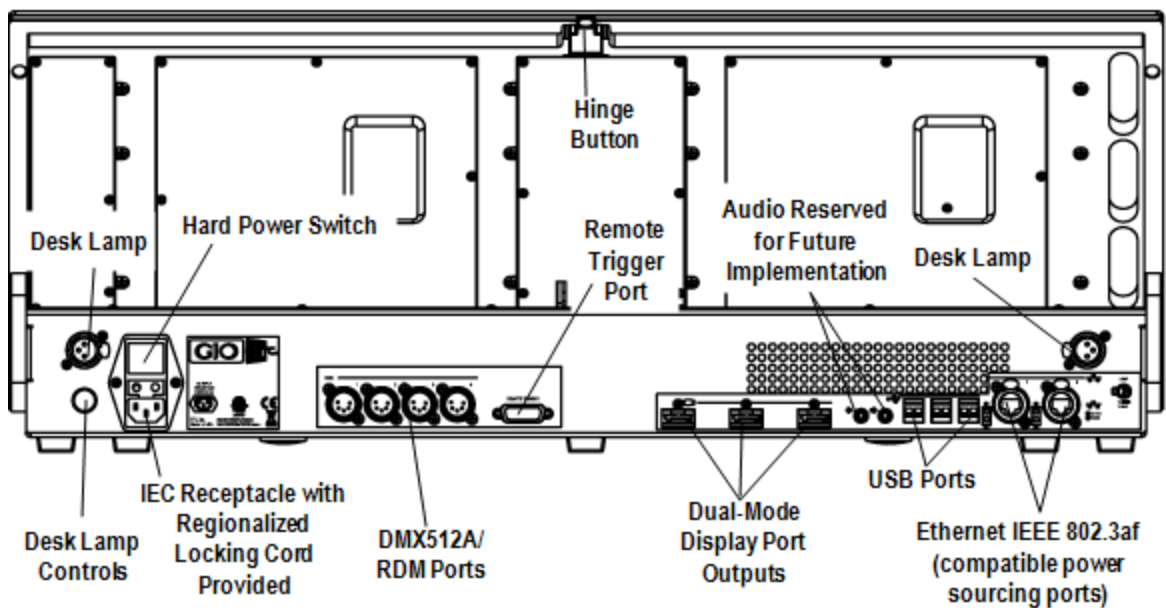
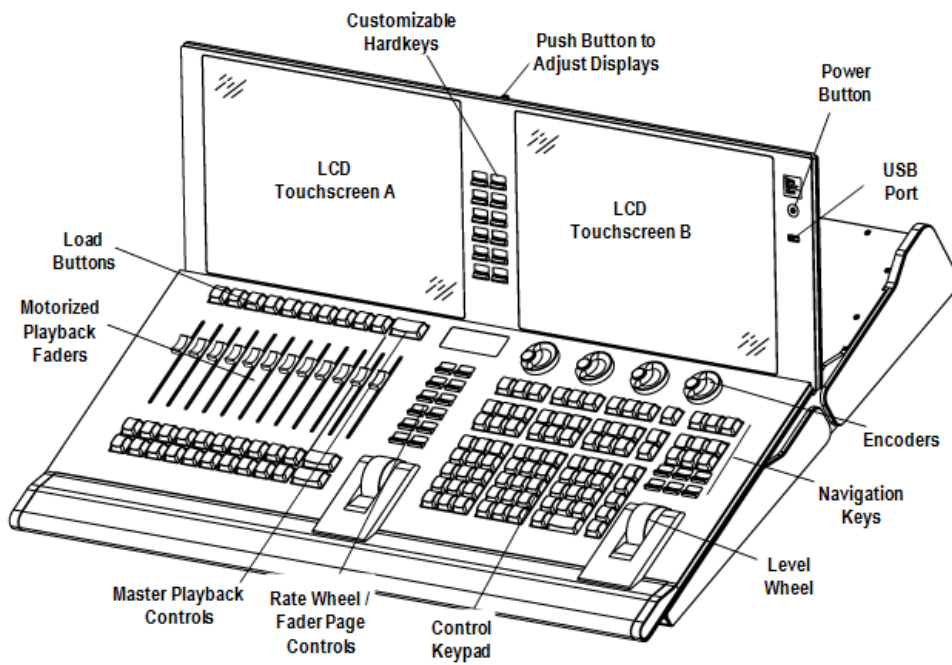

## Gio@5 Geography

Below are diagrams of the Gio @ 5 console with references made to specific areas of use. The terms and names for each area and interface are used throughout this document.

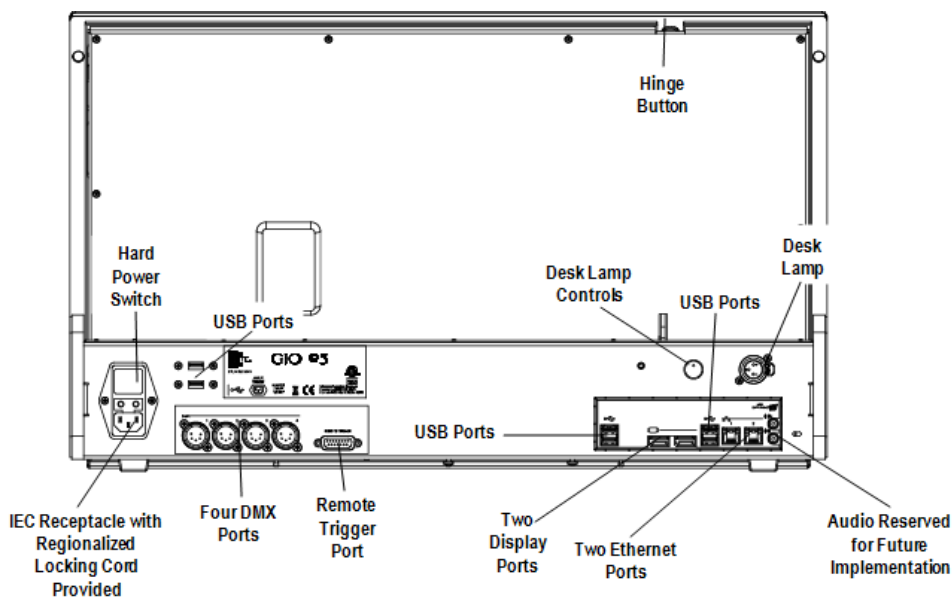
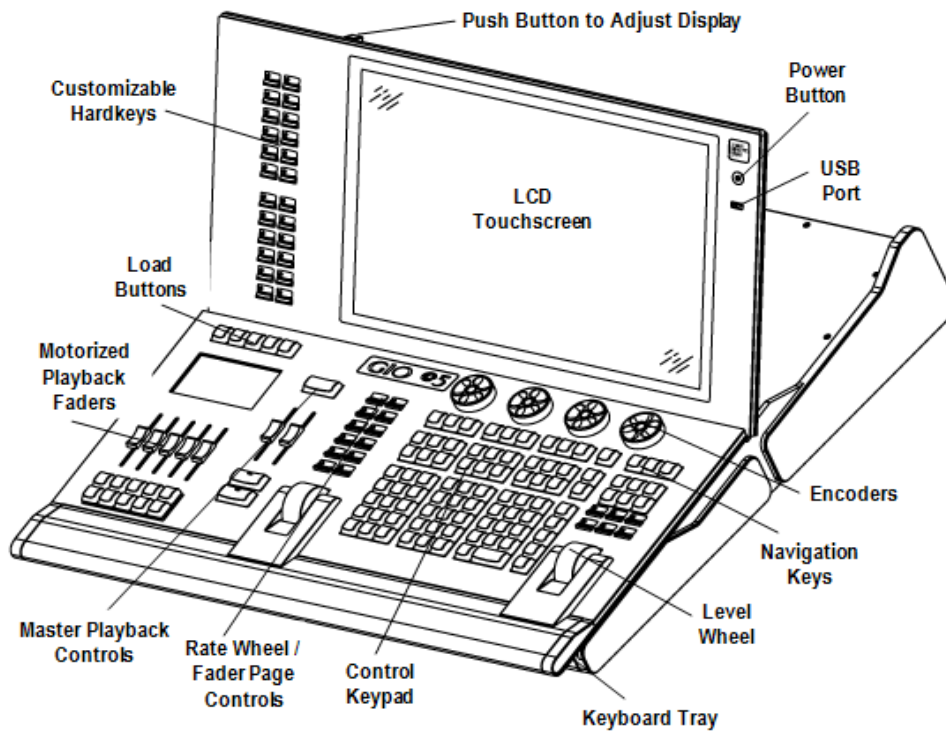

## Ion Xe Geography

Below are diagrams of Ion Xe and Ion Xe 20 with references made to specific areas of use. The terms and names for each area and interface are used throughout this manual.

# Ion Xe

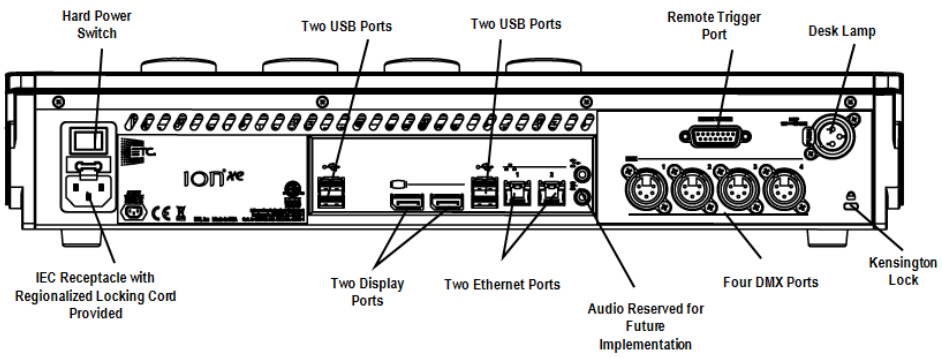
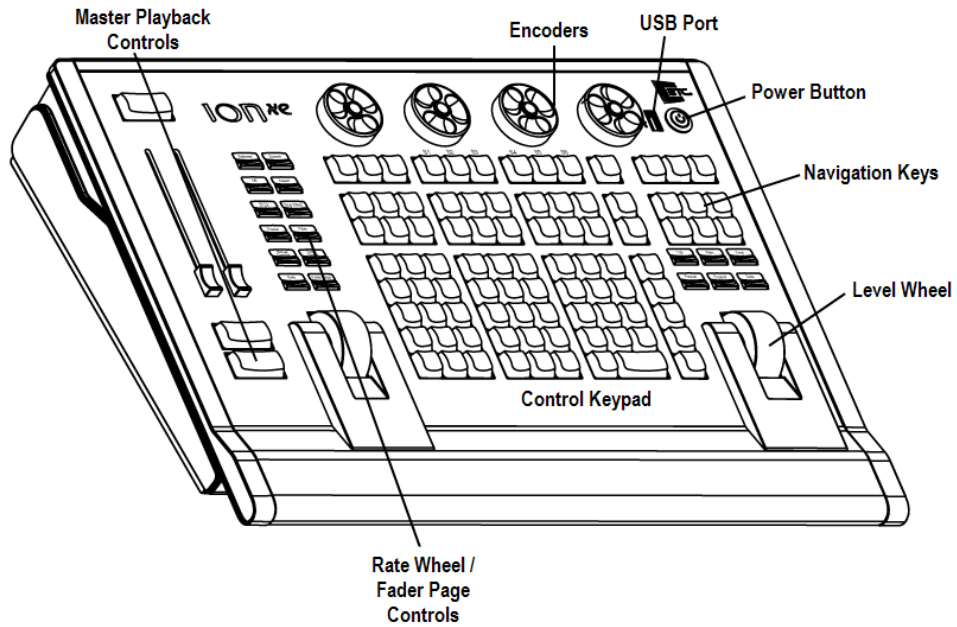

## Ion Xe 20

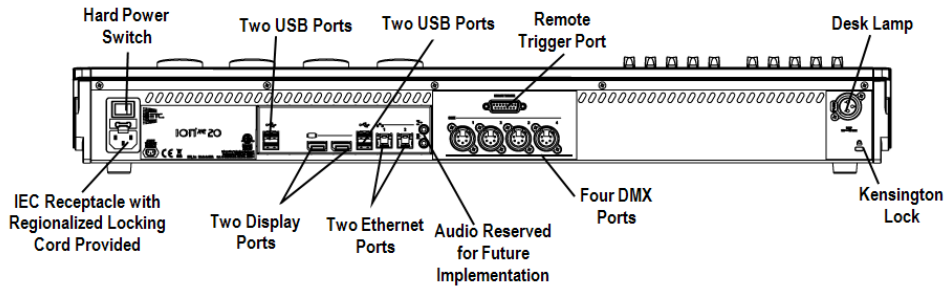
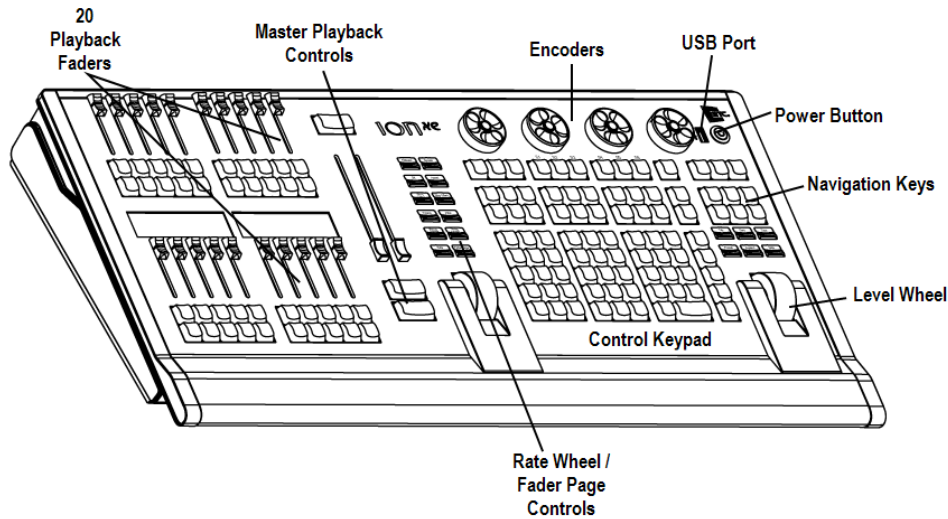

**WARNING:** This device contains a lithium battery. Battery may explode if mistreated. Do not recharge, disassemble or dispose of in fire.



**CAUTION:** For continued protection against risk of fire, replace only with same type and rating of fuse.



**ATTENTION :** Pour ne pas compromettre la protection contre les risques d'incendie, remplacer par un fusible de même type et de mêmes caractéristiques nominales.



**CAUTION:** Power cord must be connected using an earth ground connection.

## Element 2 Geography

Below is a diagram of Element 2 with references made to specific areas of use. The terms and names for each area and interface are used throughout this manual.

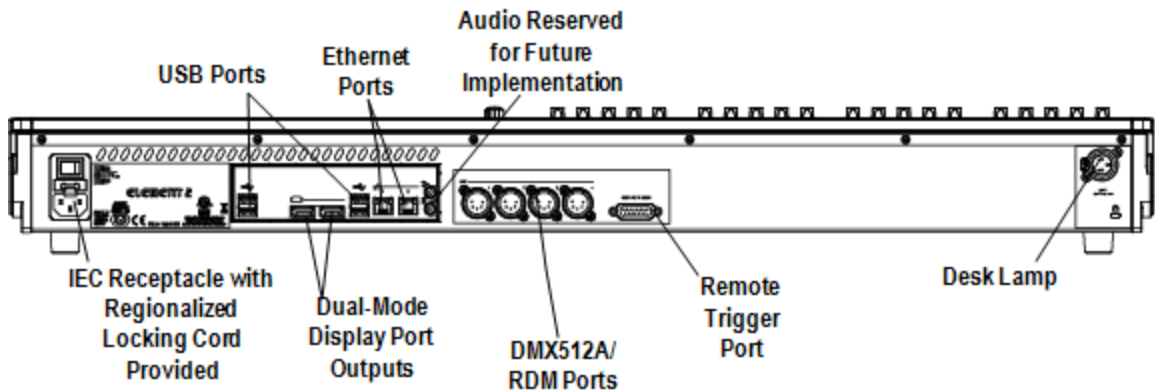
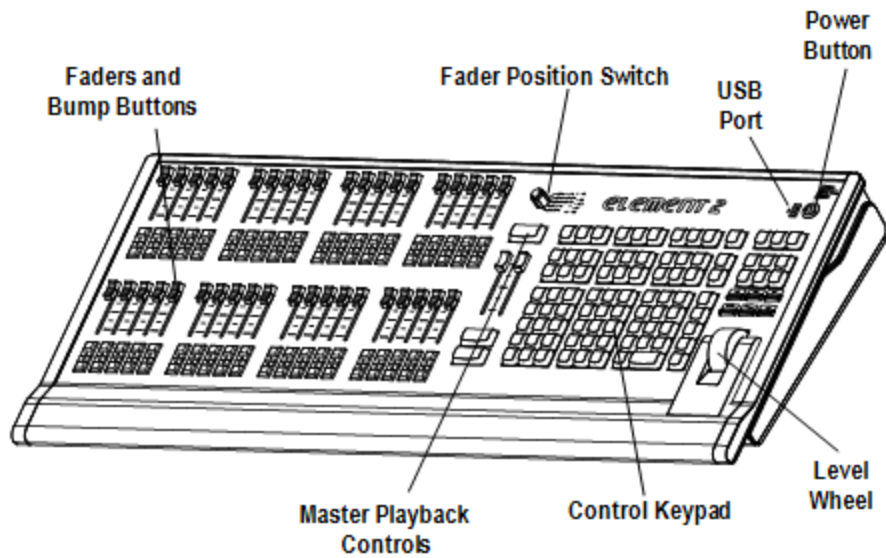

**WARNING:** This device contains a lithium battery. Battery may explode if mistreated. Do not recharge, disassemble or dispose of in fire.



**CAUTION:** For continued protection against risk of fire, replace only with same type and rating of fuse.



**ATTENTION :** Pour ne pas compromettre la protection contre les risques d'incendie, remplacer par un fusible de même type et de mêmes caractéristiques nominales.



**CAUTION:** Power cord must be connected using an earth ground connection.

## Console Components

This section discusses the various console components that were called out in the geography section.

- [Power Button](#)
- [USB Ports](#)
- [Touchscreens](#)
- [External Monitors](#)
- [Backlit Keys](#)
- [Control Keypad](#)
- [Navigation Keypad](#)
- [Fader Control Buttons](#)
- [Rate and Fader Page](#)
- [Grandmaster and Blackout](#)
- [Level Wheel](#)
- [Master Playback Controls](#)
- [Encoders](#)
- [Customizable Hardkeys](#)
- [Parameter and Category Buttons](#)
- [Load Buttons](#)
- [Motorized Faders](#)
- [Ethernet Ports](#)
- [Littlites®](#)
- [Outputting DMX](#)

### Power Button

The power button on the front of the console is used to power up or power down. A separate hard power switch, located on the rear panel, can be used to disconnect power from the console's internal components.



**CAUTION:** *It is recommended that you safely power down the console through the software, Displays>Power Off Device, before disconnecting power from the console.*

---



**WARNING:** Before servicing your console, you must switch off the power on the rear panel and disconnect the power cord completely.

---

### USB Ports

One USB port is provided on the front of the console to connect any USB storage device. Additional USB ports on the rear panel and in the keyboard tray of the console connect peripherals such as an alphanumeric keyboard, pointing device, or touchscreen control for external monitors.

Eos has two USB ports on the front of the console, and additional ports on the rear panel.



**CAUTION:** *The USB ports cannot be used for charging devices such as cell phones.*

---



## Touchscreens

### ***Eos Ti***

Eos Ti is designed with three internal LCD touchscreen displays. LCD touchscreens A & B may be used to display show data (with touchscreen interface), or they may be used as direct selects or a variety of other virtual controls and displays.

The touchscreen angle can be adjusted by pushing the button in the center top of the display and moving the panel up or down.

### ***Eos***

Eos is designed with two internal 15" LCD touch screen displays. Each LCD may be used to display show data (with touchscreen interface), or they may be used as direct selects, with or without the button modules. A variety of other virtual controls and any display may be placed on the internal touchscreens.

### ***Gio***

Gio is designed with two internal LCD touchscreen displays. Each LCD touchscreen may be used to display show data (with touchscreen interface), or they may be used as direct selects or a variety of other virtual controls and displays.

The touchscreen angle can be adjusted by pushing the button in the center top of the display and moving the panel up or down.

### ***Gio @ 5***

Gio @ 5 is designed with an internal LCD touchscreen display. The LCD touchscreen may be used to display show data (with touchscreen interface), or they may be used as direct selects or a variety of other virtual controls.

The touchscreen angle can be adjusted by pushing the button in the left side top of the display and moving the panel up or down.

## ***Adjusting the LCD Brightness***

The brightness level for the LCD touchscreens can be adjusted. This is done in **Setup> Device> Brightness Settings> LCD**. The range for the brightness level is 5-100%, with 100% being the default setting. See [Brightness Settings \(on page 165\)](#) for more information.

You can control the brightness by using a Live Master. See [Live Master \(on page 165\)](#) for more information.

## **External Monitors**

Eos, Eos Ti, and Gio support up to three external monitors. Eos supports DVI or SVGA. Eos Ti and Gio support Windows 7 compatible display port monitors.

Gio @ 5, Ion Xe, and Element 2 support up to two external Windows 7 compatible display port monitors.



**Note:** While it is possible to assign a resolution lower than the minimum (1280x1024), it is recommended to be at 1280x1024 or higher.

---

For monitor configuration, please see [Monitor Arrangement \(on page 457\)](#).

## Backlit Keys



**Note:** Backlit keys are not available on Eos and Element 2.

Backlit keys are provided on the facepanel. The brightness level for those keys can be adjusted in **Setup> Device> Brightness Settings> Backlight**. See [Brightness Settings \(on page 165\)](#).

You can control the brightness by using a Live Master. See [Live Master \(on page 165\)](#).

When your console has been idle for 10 minutes, the backlit keys will fade their intensity down by 10%. Any key press on either the facepanel keypad, an external keyboard, move of the mouse, or touch of a touchscreen will return the keys to their set intensity level.

### Control Keypad

The control keypad area is divided into several sections including record targets, numeric keypad with modifiers, display, softkeys, navigation, and special function controls.

Display and navigation keys are used for quick access to common displays, format, paging, and navigation within displays.

### Navigation Keypad

Used for quick access to the Live and Blind displays, tab selection, location, paging and navigation within displays.

### Fader Control Buttons

Fader control buttons are provided for easy local control of fader behavior. Control buttons include: **[Manual Override]**, **[Spread]**, **[Release]**, **[Off]**, **[Assert]**, **[Go to Cue 0]**, **[Stop Effect]**, **[Freeze]**, **[Filter]**, and **[Timing Disable]**. Individual faders are provided with immediate controls including: Go, Stop and Back (for playbacks), bump and assert/ group control (when submasters), or blackout and blackout enable when configured as grandmasters.

On Element 2, the **{Fader Control}** softkey is used to access the fader control softkeys. Control softkeys include: **{Manual Override}**, **{Rate}**, **{Release}**, **{Off}**, **{Assert}**, **{Go to Cue 0}**, **{Stop Effect}**, **{Freeze}**, **{Filter}**, and **{Timing Disable}**.

See [Playback Fader Controls \(on page 310\)](#) for more information.

### Rate and Fader Page

**[Rate]** and **[Fader Page]** buttons are provided for use with the faders. **[Rate]** is used for rate control of a fader. See [Using Rate Override \(on page 313\)](#) for more information. **[Fader Page]** is used to access additional pages of faders. See [Changing Fader Pages \(on page 310\)](#) for more information.

On Element 2, **{Rate}** is part of the **{Fader Control}** options. Press **[Live]** to see the **{Fader Control}** softkey. To change the fader page on Element 2, press **{Page Subs}**. See [Paging Submasters \(on page 354\)](#) for more information.

### Grandmaster and Blackout

The grandmaster inhibits all live intensity values. If the grandmaster is set at 50%, all live intensities will be at 50% of their actual values.

Blackout sets all lighting levels to zero.

If a grandmaster is set to a value other than 100%, a grandmaster button with the set value will be shown at the top of each display. If blackout is currently on, a blackout button will be shown at the top of the displays.



Clicking on either button will open a new display which will allow you to turn off blackout and set the grandmaster to a different level.



## Level Wheel

Adjusts intensity for selected channels. It also provides scrolling and zoom functions in various modes. See [Level Wheel \(on page 175\)](#) for more information.

## Master Playback Controls

The master playback fader pair is located to the left of the control keypad. The master is a split cross-fader pair. The two buttons beneath the master fader pair are **[Go]** and **[Stop/Back]**. The **[Load]** button is located directly above the fader pair and is used to load a specified cue onto the master playback.

## Encoders



**Note:** On Element 2, you can access encoder control by using the ML controls display. See [Moving Light Controls \(on page 77\)](#) for more information.

## *Eos and Eos Ti Encoders and Parameter LCD*

Encoders and an associated touch screen for control of non-intensity parameters are provided on the lower right of the console. The two larger encoders at the bottom are dedicated for pan and tilt control. The remaining four encoders on the right are pageable controls, which are populated on the LCD with the parameters used in your show.

### *Gio Encoders*

Encoders are provided above the control keypad. The four encoders are pageable controls, which are populated with the parameters used in your show. Current encoder mapping is indicated at all times, and the **[Encoder Control]** button opens full control on LCD touchscreen B.

Directly under the middle two encoders are six hardkeys for encoder control. From left to right, these encoder paging keys control intensity, focus, color, shutter, image, and form. Pressing any of these will change the parameters controlled by the encoders. To view other available encoder pages, simply press the encoder paging keys to advance the pages.

**[Encoder Paging Keys] & [#]** will take you directly to a page. **[Flexi] & [Encoder Paging Keys]** will toggle the flexi encoder states. See [Flexi Encoders \(on page 77\)](#) for more information. To post a

parameter category to the command line, use the parameter category buttons located in the CIA above the Mini Encoder display. To post beam to the command line, double press the shutter, image, or form parameter category buttons.

### ***Gio @ 5 Encoders***

Encoders are provided above the control keypad, below the touchscreen. The four encoders are pageable controls, which are populated with the parameters used in your show. Current encoder mapping is indicated at all times, and the **[Encoder Display]** button opens full control on the screen.

### ***Ion Xe Encoders***

Encoders are provided above the control keypad. The four encoders are pageable controls, which are populated with the parameters used in your show. Current encoder mapping is indicated at all times, and the **[Encoder Control]** button opens full control on the screen.

## **Customizable Hardkeys**

### ***Eos Ti Customizable Hardkeys***

Eos Ti has twenty one customizable hardkeys. Twenty are located between the two main touchscreens, and default to macros 801-820. The other is between **[Label/Note]** and **[About]** on the facepanel, and defaults to macro 821.

Functionality for the hardkeys can be defined in **ECU> Buttons> Ti Face Panel Buttons**. See for configuration instructions.

### ***Gio Customizable Hardkeys***

Gio has nine customizable hardkeys. Eight are located between the two main touchscreens, and default to macros 801-808. The other is between **[Label/Note]** and **[About]** on the facepanel, and defaults to macro 821.

Functionality for the hardkeys can be defined in **ECU> Buttons> Gio Face Panel Buttons**. See for configuration instructions.

### ***Gio @ 5 Customizable Hardkeys***

Gio @ 5 has twenty one customizable hardkeys. Twenty are located to the left of the main touchscreen, and default to macros 801-820. The other is between **[Label/Note]** and **[About]** on the facepanel, and defaults to macro 821.

Functionality for the hardkeys can be defined in **ECU> Buttons> Gio @ 5 Face Panel Buttons**. See for configuration instructions.

## **Parameter and Category Buttons**

Parameter buttons are posted in the Central Information Area (CIA). When certain functions need to be accessed, a group of related parameters will populate in the parameter category display.

## **Load Buttons**

Load buttons are located above the faders and are used to load the specified target to the associated fader or place special conditions on that fader.

Element 2 uses a combination of both bump buttons beneath the faders as load buttons for submasters, presets, and palettes.

See [Assigning Faders Manually \(on page 309\)](#) for more information.

## Motorized Faders



**Note:** *Ion Xe and Element 2 do not come with motorized faders.*

One dedicated main playback and ten motorized faders are provided. The faders may be configured as playbacks, submasters, or grandmasters. A hundred pages of 10 faders each are provided. The bottom of the touchscreen shows fader status information and provides a load button for each fader.

Gio @ 5 has one dedicated main playback and five configurable motorized faders. The faders may be configured as cue playbacks, submasters, grandmasters, or other record targets. A hundred pages of 10 faders each are provided. Gio @ 5 has a small fader LCD display that shows information for the five motorized faders.

## Ethernet Ports

Ethernet ports are for connecting to a network switch, network gateways, and accessory devices. Each port is on a separate NIC.

Eos has Ethernet ports that have Power-Over-Ethernet for connection to a network switch, network gateways, and accessory devices. All four ports share the same NIC.

For configuration of your Ethernet ports, please see [Network Settings \(on page 459\)](#).

## Littlites®

You may connect Littlites to the back of your console.

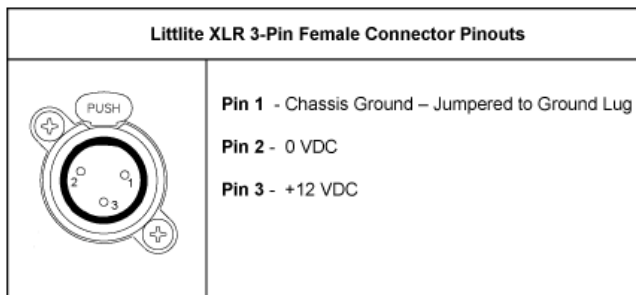

## Dimming Littlites

Desk lamps, such as Littlites, can be dimmed from within the software application. They can also be dimmed using the desk lamp control knob on the rear panel.



**Note:** *Eos does not have a desk lamp control knob.*

Desk lamp controls are found in **Setup> Device> Brightness Settings>Light Levels**. The **{Desk Lamp}** slider has a range of 0% (dimkest) to 100% (brightest). The default setting is 0%. The console will set the desk lamp to this setting on startup of the application. See [Brightness Settings \(on page 165\)](#)

The desk lamps can also be controlled by holding down **[Displays]** and rolling the level wheel.

## Outputting DMX

In order to output control levels from your console, you can use the DMX ports on the back of the console and/or you may connect a gateway or node. If your device receives Net3 or ETCNet2 directly, no gateway or node is required.

**Note:** *In order to output levels from your Eos console, you must connect a Net3 gateway or Net2 node. If your device receives Net3 or ETCNet2 directly, no gateway or node is required.*

Eos Ti, Gio, Gio @ 5, Ion Xe, and Element 2 have DMX ports. To output, connect one 5 pin XLR cable per port. The first port will default to outputting the first universe of DMX, addresses 1-512, the second port to the second universe, outputting addresses 513-1024, the third port to the third universe, outputting addresses 1025-1536, and the fourth port to the fourth universe, outputting addresses 1537-2048. Configuring the DMX ports to something other than the defaults is done in **Browser>Setup>System Settings>Output**.

See [Outputs \(on page 157\)](#) for information on reconfiguring the DMX ports.

Gateways will function with your console out of the box without previous configuration. However if custom configuration is required, you will need to use Net3 Concert or GCE (Gateway Configuration Editor). Concert is installed by default and can be accessed in **ECU>Settings>Maintenance>Net3 Concert**. Concert is available for download from our website, [etconnect.com](http://etconnect.com). GCE software can also be downloaded from the ETC website.

For more information on Net3 gateways, see the product literature that accompanied the hardware or download it from our website, [etconnect.com](http://etconnect.com).

## Cleaning Your Console

Should the exterior of your console require cleaning, you may gently wipe it with a dampened (not dripping), non-abrasive paper towel or soft cloth.

If this does not clean the console sufficiently, you may apply some window cleaner (containing ammonia is fine) to the cloth and repeat the process until clean.

## Console Capacities

### Output Parameters

- 4k (Min) 24k (Max) - Eos Ti, Gio, Gio @ 5
- 2k (Min) 12k (Max) - Ion Xe
- 1k (Min) 6k (Max) - Element 2

### Channel Counts

- 32,768 channels (can be any number from 1 to 99,999)

### Cues and Cue Lists

- Up to 999 cue lists
- Up to 10,000 cues

### Record Targets

- 1,000 Groups
- 1,000 x 4 Palettes (Intensity, Focus, Color and Beam)
- 1,000 Presets
- 1,000 Effects
- 99,999 Macros
- 1,000 Snapshots

- 1,000 Curves
- 1,000 Color Paths

## **Faders**

- Eos, Eos Ti, Gio, and Gio @ 5 have 1 dedicated Motorized Master Playback pair, with Go and Stop/Back
- Eos, Eos Ti, and Gio have 10 motorized faders x 100 pages for configurable cue lists, submasters, grand masters, IFCB Palette/ Presets lists, or individual instances
- Gio @ 5 has 5 motorized faders x 100 pages for configurable cue lists, submasters, grand masters, IFCB Palette/ Presets lists, or individual instances
- Ion Xe and Ion Xe 20 have 1 dedicated Master Playback pair, with Go and Stop/ Back
- Ion Xe 20 has 20 faders with 40 configurable buttons.
- Element 2 has 1 dedicated Master Playback pair, with Go and Stop/ Back
- Element 2 has 40 faders with 80 configurable buttons.
- a maximum of 200 configurable cue playbacks, with Go and Stop /Back (Not on Element 2)
- a maximum of 1000 configurable submasters, with Bump and Assert/ channel select





# Chapter 2

## System Basics

---

About System Basics .....	30
The Central Information Area (CIA) .....	30
Browser .....	33
Softkeys .....	35
Displays .....	36
Display Control and Navigation .....	41
Live and Blind Displays .....	48
Playback Status Display .....	60
Using Direct Selects .....	68
Encoders .....	73
Moving Light Controls .....	77
Fader Configuration .....	78
Virtual Keyboard .....	86
sACN Output Viewer .....	86

## About System Basics

This section explains the base level procedures for setting up, navigating, and understanding how to operate your console.

### Power Up the Console

1. Attach the appropriate power cable to the IEC connector on the rear of the console.
2. Press the I/O switch (I is "on") next to the IEC connector on the rear of the console to turn power on. This will provide power to all internal electronics.
3. Press the power button, located on the face panel. The button LED will illuminate blue to indicate the console is running. The console will boot up into the Eos environment. The system is now ready for use.



**Note:** You can go straight to the welcome screen by adjusting a setting in the ECU. See [Open in Shell E.C.U \(on page 455\)](#) in the ECU appendix.

### Power Down the Console

1. After saving your show (see [Saving the Current Show File \(on page 97\)](#)), in the browser menu select **Power Off Device**. A dialogue box opens asking you to confirm.
2. Confirm this command by pressing {OK} in the dialog box. The console will power down.



**Note:** These are persistent storage systems. Therefore if you shut down your system without saving the show file, you will return to the same place in your show when you reboot.



**Note:** The console will display an improper shutdown message on the next power up if the console was not powered down from the browser menu or welcome screen.

## The Central Information Area (CIA)

The Central Information Area (CIA) is the lower portion of the screen. By default, the CIA consists of three primary areas: the command line, the parameter display, and the browser. Softkeys are also contained within the CIA.



**Note:** Gio and Gio @ 5 have a mini encoder display as part of their CIA. See [Mini Encoder Display \(on page 76\)](#) for more information.



On Element 2, the CIA looks like this:

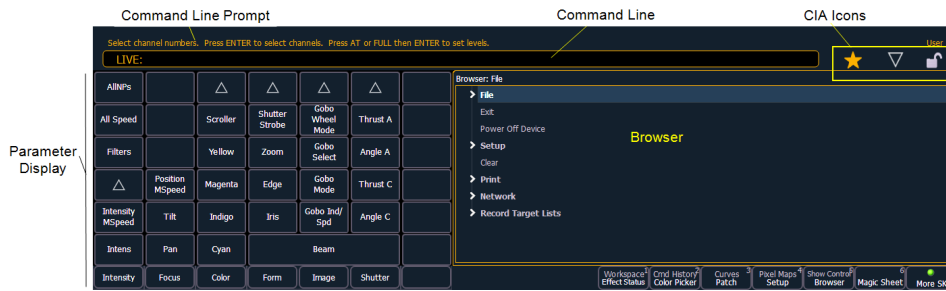

## CIA Icons

There are three icons located above the CIA.

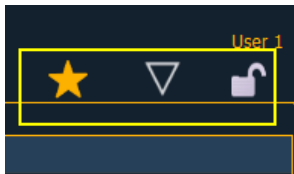

### ***Favorite CIA Display***

You can select a favorite default display for the CIA that will show when [Displays] is pressed. The standard default display for the CIA is the Browser.

The favorite display will show a **gold star** icon at the top of the CIA by the arrow and lock icons. Displays that can be selected as a favorite, but are currently not, will show a **gray star** at the top of the CIA. Click on the **gray star** to make that display your favorite. That display will now be the new default display for the CIA. Displays that show up in the CIA but cannot be the default display will not show the star icon.

### ***Collapse/ Expand the CIA***

It is possible to collapse the CIA from view. To do this, you can click the **arrow** icon above the CIA. The CIA will collapse from view, exposing a larger viewing area of whatever display is visible above the CIA. The arrow will move to the bottom of the screen.

To expand the CIA into view again, click the **arrow** at the bottom of the screen. The CIA will reopen.

### ***Lock the CIA***

You can lock the CIA in place to prevent it from being collapsed or viewed.

To lock the CIA, click on the **lock** above the browser. The lock will "lock".

To unlock the CIA, click the sunken **lock** again.



**Note:** While locked, the CIA can still be collapsed or expanded by clicking the **arrow** icon. You can also use [Displays] & [Page ▲] to expand or [Displays] & [Page ▼] to collapse.

## The Command Line

This is the area where commands appear when entered. When in Live, this line is bordered in gold. The command line will display in blue when in Blind.



**Note:** Press **[Clear]** to remove commands from a terminated command line. Use **[Shift] & [Clear]** to remove commands from a command line that is not terminated.

See [Syntax Structure \(on page 5\)](#) for more information on using the command line.

## Command Line Prompt



**Note:** This feature is only available on Element 2.

Directly above the command line, you will see gold text that will prompt you for an action. The prompts will change between different displays and actions, and provide useful information to aid you in programming.

Command line prompts can be disabled in Setup. See [Display Help Prompts \(on page 164\)](#) for more information.

## Command Line Search

Command line search allows you to search your recorded targets, effects, and channels. The search window will display the object, it's number, and any label you have given it.

Press the **Search** icon at the end of the command line or use **[Shift] & [About]** to open the command line search window.

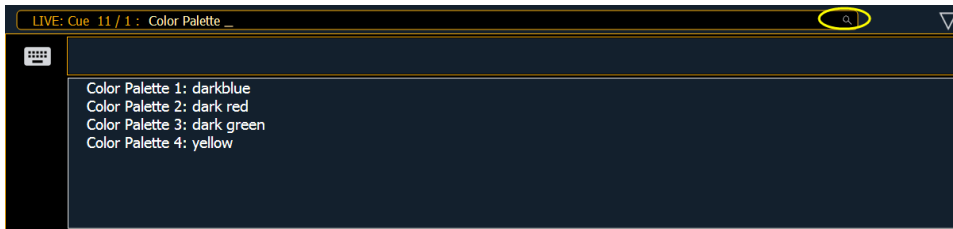

## Parameter Display

This display shows the parameters available for patched channels. It is also where you can select which parameters to view in the Live and/or Blind displays, or select parameters for command line control. The parameter display will dynamically change depending on the channel (fixture) selected and its applicable parameters.

For more information on using the parameter display, see [Using the Parameter Display \(on page 175\)](#).

### Parameter Category Button Labels

These labels correspond to the buttons directly beneath the Parameter display. They indicate the six buttons; Intensity, Focus, Color, and the three Beam categories (Form, Image, and Shutter).

### Collapsing the Parameter Display

The parameter display can be collapsed when working with some displays that use the CIA, such as About and Query. A collapse/ expand arrow will display in the last column where this option is available.

When collapsed, only the **{All NPs}**, **{All Speed}**, and **{Expand Arrow}** buttons will be displayed.

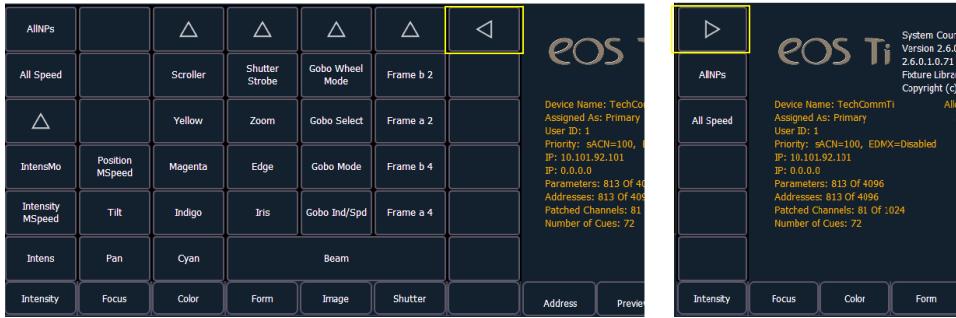

## Labeling

[Label] is used to attach an alphanumeric label to an object such as cues, channels, submasters, etc.

[Label] [Label] when appended to a record target command, clears the current label. This includes show file labels.

## Editing Labels

The page arrow keys on the console or an external alphanumeric keyboard can be used to move the cursor within a label to aid in editing.

- [Page ▲] - takes the cursor to the beginning of the label.
- [Page ▼] - takes the cursor to the end of the label.
- [Page ◀] - moves the cursor to the left.
- [Page ▶] - moves the cursor to the right.

## Browser

The browser is the interface for numerous functions including saving a show, loading a show, opening displays, and many other functions. Press [Displays] to open the browser. See [Using the Browser \(below\)](#).

To learn more about saving and loading a show file, see [About Managing Show Files \(on page 90\)](#) for more information.

## Using the Browser

To use the browser, you must first draw focus to it by touching anywhere in the browser area of the CIA. If the browser is not visible, pressing [Displays]>[Browser] will bring up the browser.

When focus is on the browser, the window border highlights in gold. The paging keys will now control selection in the browser.

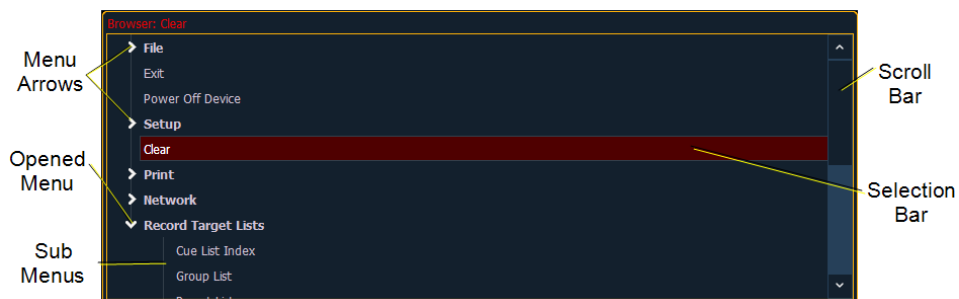

- Use the page arrow keys to move the selection bar up and down the list. You may also use the level wheel to scroll through the list.
- When the bar highlights the desired menu, press **[Page ▶]** to open the menu.
- Continue pressing **[Page ▶]** to open submenus.
- Scroll to the item you wish to open using **[Page ▲]** or **[Page ▼]** and then press **[Select]** or double click on it. You may also touch the item you wish to open and then press **[Select]** or double tap.
- If you wish to close a submenu scroll to that item and press **[Page ◀]**.
- Additional presses of **[Displays]** will minimize or restore the CIA.
- To draw focus to the browser at any time, press any area within it or press the **[Displays]** button.



**Note:** File folders display with a folder icon beside their name.



**Note:** Previous versions of a showfile will be displayed in dark gray text. To see previous versions of a showfile, you must click on the arrow to the left of the showfile name or use **[Page ▶]**.



**Note:** The **[Select]** key can be used to confirm a choice in the browser.

## Browser Color Coding

The following color coding for selected items is used in the browser:

- Save - green
- Save As - green
- Open - red
- Merge - yellow
- New -red
- Clear -red

## Clear Functions

You can access the various clear options from the browser by selecting **{Clear}** from the main browser menu. The clear functions window will open in the CIA.

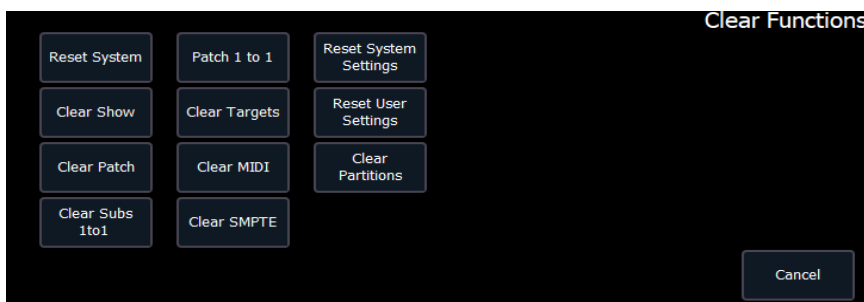

From this menu you can select one of the available clear options by clicking on the desired button in the CIA. Eos will ask you for a confirmation before performing the selected clear. For **{Clear Targets}**, Eos will allow you to choose which record targets you want to clear.



**CAUTION:** Clear functions cannot be undone by using the Undo option.

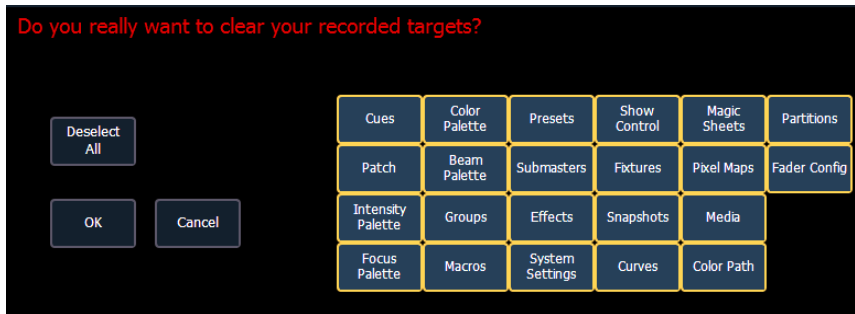

From the **{Clear Targets}** screen you can select which record targets you wish to clear. The buttons at the center of the CIA represent all of the record targets that you can choose to clear. By default all components are selected (gray) and will be cleared. To withhold any targets from being cleared, simply deselect them in the CIA by clicking the respective button. To deselect all of the targets, click the **{Deselect All}** button.

To reselect all targets, click the **{Select All}** button and all buttons will return to gray (selected). To stop the process, click the **{Cancel}** button.

When you have selected or deselected all of the record targets you require, click **{OK}**.

After clearing, the CIA will return to the browser. If you want to perform additional clear functions, you must select **{Clear}** from the browser again.

To exit the clear functions screen without clearing, press the **[Displays]** key at any time or select a clear button and then select **{Cancel}** from the confirmation screen.

### **Reset System vs Clear Show**

Using **{Reset System}** will open a new show file and reset the Setup options to their defaults. Using **{Clear Show}** will only open a new show file.

### **Patch 1 to 1 vs Clear Patch**

Using **{Patch 1 to 1}** will clear your patch and set it to a 1-to-1 patch. Using **{Clear Patch}** will only clear out the patch.

### **Locking the Facepanel**

It is possible to lock out the facepanel, which prevents any actions from the command line or CIA. To lock out the facepanel, press **[Shift] & [Escape]**. To unlock the facepanel, press **[Shift] & [Escape]** again.



**Note:** This will also lock any wings or USB connected peripherals.

### **Softkeys**

Some of the features and displays in Eos are accessible from the softkeys, which are located under the Browser. Softkeys are indicated in documentation with **bold {braces}**.

The softkeys are context sensitive, therefore they repaint to display softkeys relevant to the display or command you are working with. The white labels on the bottom row indicate the active softkeys. The gray labels in the top row indicate the second page of available softkeys, available by pressing the **[More SK]** button.

On Element 2, those softkeys correspond to buttons **[S1]** - **[S6]** and **[More SK]** on the facepanel.

For Gio, Gio @5, Ion Xe, and the Eos Programming Wing, you can hold down **[More SK]** & **Encoder Category Button** to access the second page of softkeys.

### **Example:**

With a channel on the command line, pressing **[More SK]** & **[Intensity]** will post Make Manual on the command line.

## **Changing Softkey Pages**

When there are more relative softkeys than the six available buttons, both gray and white softkey labels will be visible. The white labels on the bottom row of the label window indicate the active softkeys. The gray labels in the top row indicate the second page of softkeys.

To access the second page of softkeys, press the **[More SK]** button. To access the previous softkeys, press **[More SK]** again.

## **Displays**

There are several terms that are useful to know when discussing the displays on your console:

- **Monitors** - refers to any physical monitor or touchscreen device connected to your console. The monitor number will display in the upper left corner of the screen.
- **Workspaces** - offers independent display control on all of your connected monitors. Every monitor can have up to three workspaces.
- **Frames** - offers layout options to your workspaces.
- **Tabs** - offers the ability to view multiple displays in one frame.
- **Displays** - are the individual views or tools available for use in programming your console. They are viewed in tabs.

Eos has the ability to have one of three different workspaces active on individual monitors, as well as to have up to four frames in use in any workspace. Each frame can hold multiple tabs. Each tab contains one display.



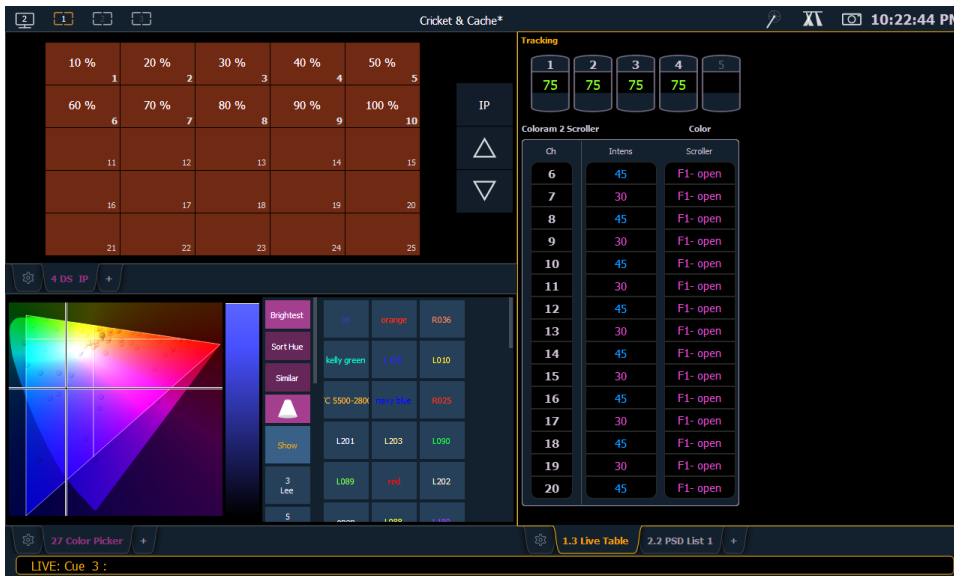

## Workspaces

Workspaces offer independent display control on all of your connected monitors. Every monitor can have up to three workspaces, identified by the workspace icons in the upper left corner of any monitor (including any integrated touchscreens with your console).

You can use **[Tab] & [Page ▲]** and **[Tab] & [Page ▼]** to cycle through the workspaces. This will increment or decrement the current workspace and will then force all of the other workspaces to match the current workspace's number (1, 2, or 3). This is so you can quickly step through the workspaces.

### Workspaces 1, 2, and 3



These three monitor icons are used to switch between each monitor's available workspaces. Each can be set up to include any of the desired layout, displays, and controls options offered on the [Home Screen](#). Double-clicking on any of the icons will jump all connected monitors to that workspace number.

### Workspace Access From the Command Line

A **{Workspace}** softkey is available by pressing **[Displays]**. Hold **{Workspace}** and type 1, 2, or 3 to go to that workspace.



**Note:** From an alphanumeric keyboard, hold down either of the bracket buttons (**[** or **]**) and type in the number of the workspace you wish to view. For example, hold down **[** and press 2 to view workspace 2.

## Frames

Each workspace can have up to four frames in its layout. The number of frames in a workspace layout is determined by choosing the layout options offered in the [Home Screen](#).

## Tabs

Any frame can have multiple tabs open. Tabs are broken down into two categories: Control and Display. Control tabs are the virtual control options, such as the color picker and the virtual keyboard. Display tabs are the various displays available on the console, such as the playback status display and the park display.

You can open or close tabs using the Display Icons, Control Icons, or typing the **[Tab]** & the tab number. Pressing **[Shift] & [Tab]** once will clear all tabs on the selected monitor but tabs in locked frames will remain. Pressing **[Shift]** and tapping **[Tab]** twice will clear all tabs on all monitors but tabs in locked frames will remain. Tapping **[Tab]** a third time will clear all tabs on all monitors including those in locked frames.

White text in the tab indicates a Display Tab, and magenta text indicates a Control Tab.

All Display and Control Tabs have fixed *Tab Numbers* under which they open (for example, “Live” opens under Tab 1, “Patch” under Tab 12, and “Color Picker” under Tab 27).

These numbers are identified on the Home Screen in each icon. For multiple instances of the same display, the tab number will be followed with a decimal number. Additional tabs will start their numbering with n.2. When you press **[Tab]**, active focus will move numerically through all open tabs on active workspaces.

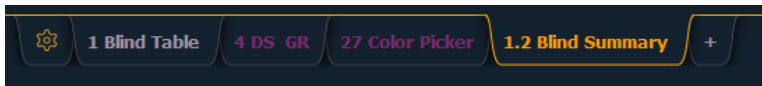

**Note:** Single clicking on a Controls Tab will bring it to the front of the frame but will not move focus to that tab unless the tab’s frame already has focus. Double clicking on a Controls Tab will bring it to the front and grab focus. Single clicking on a Display Tab will bring it to the front and grab focus.

## Tab Numbers

The following table lists the tab number for each of the Control and Display tabs:

1	Live/ Blind	11	Show Control	21	Curves	31	Lamp Controls
2	Playback Status	12	Patch	22	Intensity Palettes	32	Channels In Use
3	Magic Sheet	13	Effects	23	Focus Palettes	33	Color Path
4	Direct Selects	14	Magic Sheet List	24	Color Palettes	34	Not Currently Used
5	ML Controls	15	Submaster List	25	Beam Palettes	35	Fader List
6	Effect Status	16	Cue List	26	Presets	36	Fader Configuration
7	Keys	17	Groups	27	Color Picker	37	sACN Output View
8	Effect Channels	18	Macros	28	Virtual Faders	99	Diagnostics
9	Pixel Maps	19	Snapshots	29	About	100	User Manual
10	Pixel Preview	20	Park	30	Command History		

## Display Tabs

The following displays can be selected, and they will open in a new tab in the selected frame:



The following displays can have multiple instances open:

- Channel (Summary)
- Channel (Table)
- Split Channel
- Playback Status Display
- Magic Sheet Display
- Effect Channels
- Park

For multiple instances of the same display, the tab number will be followed with a decimal number. Additional tabs will start their numbering with n.2. If you have only one instance, there will be no decimal number.

### ***Control Tabs***

You can select from the following list of virtual controls, and they will open in a new tab in the selected frame:

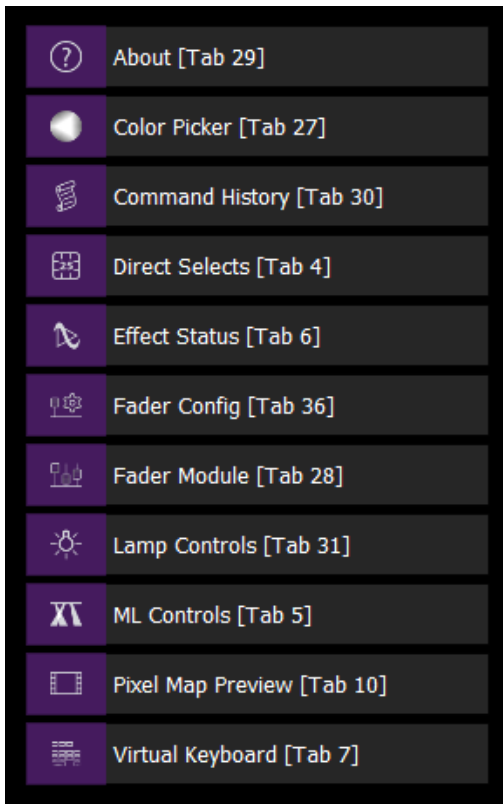

## Tab Tools

Every frame has a tab tools menu in the lower left corner of the frame. Selecting this menu icon will open the tab tools menu, which provides options for opening and closing tabs in that frame.

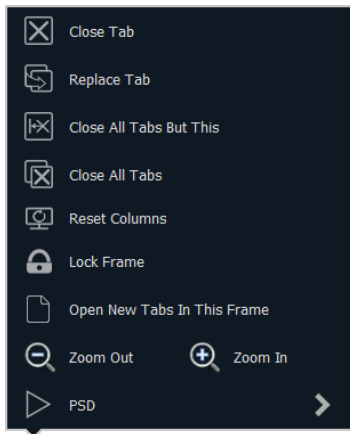

You can left click with a mouse or double tap a tab in focus to also see this menu.

The following is a list of menu options. Not all options are available for every tab.

- **Close Tab** - closes the selected tab.
- **Replace Tab** - allows you to close the current tab and choose from the Home Screen which display to replace it with. Pressing escape will return you to the previously selected tab.
- **Close All Tabs But This** - closes all of the tabs except the selected one.
- **Close All Tabs** - closes all of the tabs including the selected one.

- **Reset Columns** - resets all of the column widths in the selected tab to Eos defaults. This option will only be available for displays with columns.
- **Lock Frame** - prevents any additional tabs from being opened in the selected frame.
- **Open New Tabs In This Frame** - specifies that any new tabs opened will automatically open in the specified frame. Only one frame can have this option selected at a time.
- **Zoom Out** and **Zoom In** - zooms the selected tab.



**Note:** *If the selected display has a configuration menu, it can be accessed from the tab tools menu.*

---

## Display Control and Navigation

### Opening and Closing Displays

Displays can be opened and closed in different ways, depending on the display. Many displays are accessible from the browser, while other displays are accessible from the softkeys. The blind displays of record targets (also called “lists”) can be quickly accessed by double pressing the record target button (for example, [Cue] [Cue] opens the cue list index).

The Live/Blind display is open as tab 1. The playback status display is always open as tab 2. Neither of these displays can be closed. Multiple instances of Live/Blind and PSD can be opened.

Every display has an assigned tab number. Tab numbering is useful for navigating to views. See [Tab Numbers \(on page 38\)](#) for a list of displays and their tab numbers.

### From the Home Screen

The [Workspace Layout Menu \(on the next page\)](#) shows all of the available displays for quick selection. Click on the {+} button by the tabs to access the home screen.

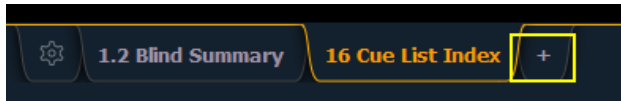

### From the Browser

Open and navigate the browser as described in [Using the Browser \(on page 33\)](#). You can open record target lists, such as the preset list or cue list index, by navigating to **Browser> Record Target Lists**.



**Note:** *Any time you wish to return to the browser, simply press [Displays].*

---

### From the Hardkeys

You can open list views of any record target by double-pressing the key for the desired record target (for example, [Cue] [Cue] opens the cue list index).

### From the Softkeys

To open any displays accessible from the softkeys, press [Displays]. The softkeys will repaint to display:

- Effect Status
- Color Picker
- Patch
- Setup

- Browser
- Magic Sheet
- Workspace
- Command History
- Curves
- Pixel Maps
- Show Control
- Mirror

Any of these softkeys will open the associated display with a single press.

## Closing Displays

To close any tab display, select the display by using the **[Tab]** key or other means of navigation. When the desired display is active, press **[Escape]** to close it.

To close a display in the CIA, press the **[Displays]** key and the browser will reappear.

To close all displays except for the live/blind display and the playback status display (tabs 1 and 2), press **[Shift] & [Tab]**.

You can also close tabs by using the Tab Tools. See [Tab Tools \(on page 40\)](#) for more information.

## Workspace Layout Menu

Upon start up or creation of a new show file, any connected monitor that is not already displaying the Live (Tab 1) or Playback Status Displays (Tab 2) will show the Workspace Layout Menu. This screen will also display when a new tab is opened.



This screen consists of four general areas, each offering different display-related options.

## Display and Control Icons

Clicking on an icon will open the appropriate display or control in a new tab.

### Display Tabs

## Control Tabs

### Layout Options

These tools offer you greater flexibility in the number of tabs you can view in any given workspace. A workspace can have up to four frames. Selecting a layout icon will assign the frame layout identified in the icon. Once a layout is assigned, you can select which displays and controls will be in which frames.

This screen also offers options for opening and closing tabs as well as resizing and resetting the monitor(s).

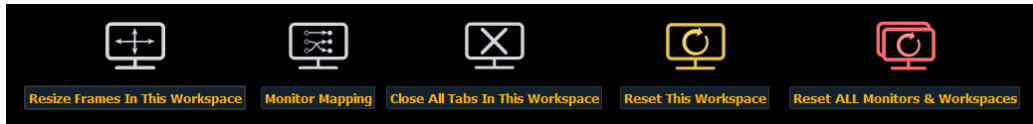

### Resize Frames In This Workspace

Select this icon to resize frames in any of the workspaces on the monitor. After selecting, resizing tools will appear between frames of the workspace and you can select and drag the resize tool icons to adjust sizing as needed.

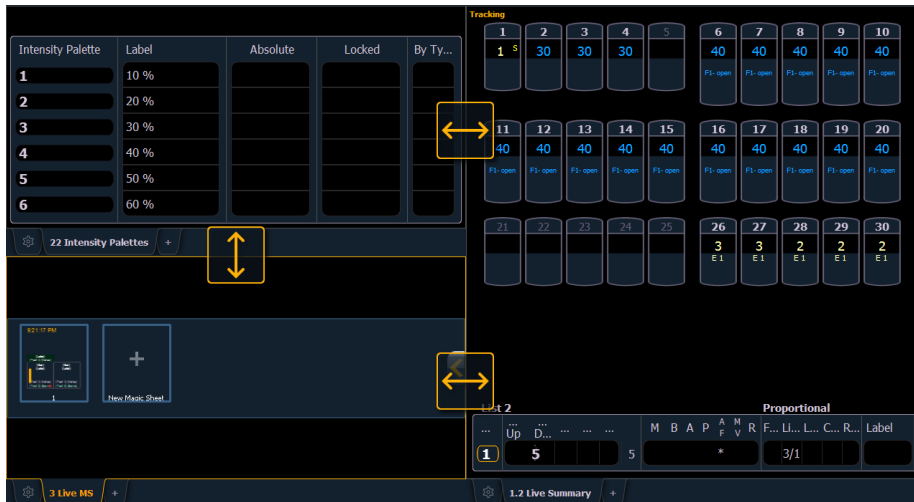

### Monitor Mapping

Select this icon to arrange your monitors without having to go into the ECU. This function allows you better control of your snapshots ([About Snapshots \(on page 384\)](#)).

Click on a monitor to display the available numbers, and then click on the number to assign it.



**Note:** On-board touchscreens are locked, and their arrangement cannot be changed.

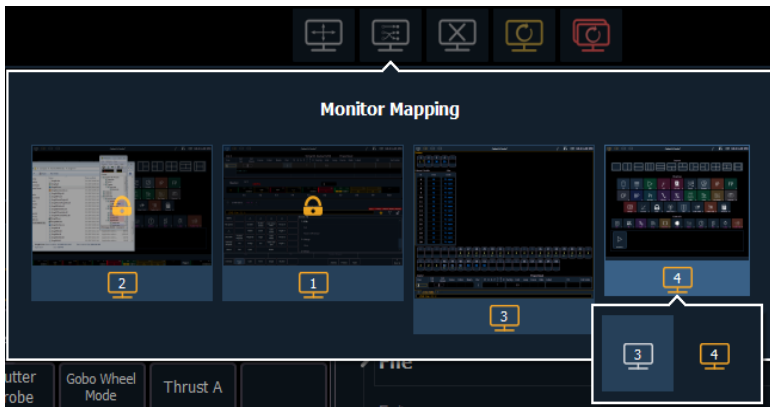

### **Close All Tabs In This Workspace**

Select this icon to close all of the tabs in the active workspace on this monitor only.

### **Reset This Workspace**

This icon will close all of the tabs and frames and will reset the layout for the active workspace to a single frame displaying the Workspace Layout Menu, from which you can select new tabs to open.

### **Reset ALL Monitors & Workspaces**

This icon will close all of the tabs and frames on all monitors, reset all layouts to a single frame, and return their workspaces to the Workspace Layout Menu, from which you can select new tabs to open.



## Single Monitor Snapshots

The snapshots displayed here are single monitor-only snapshots recorded for the visible workspace. For information about snapshots, see [About Snapshots \(on page 384\)](#). These snapshots can be recalled from any selected monitor from the Workspace Layout Menu. You can recall a monitor-only snapshot from the command line by using the syntax **[Snapshot] [n] [Enter]**. When recalled from the command line, the selected snapshot will only affect the monitor from which it was originally recorded.

To record a monitor-only snapshot, press the **{New Snapshot}** button on the Display Controls menu screen. **[Delete] [Snapshot] [n] [Enter] [Enter]** will delete a monitor-only snapshot.

All snapshots can be viewed on the snapshot list display, which can be opened by pressing **[Snapshot] [Snapshot]** or from the Workspace Layout Menu.

### Updating a Single Monitor Snapshot

A single monitor snapshot can be updated or deleted by right clicking on its icon in the Snapshot area of the Workspace Layout Menu.

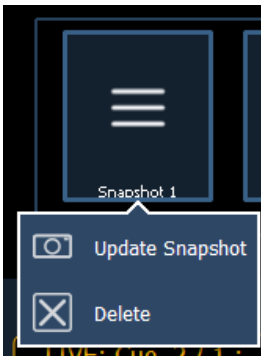

## Using Expand With Displays

**[Expand]** allows you to quickly create additional frames on a monitor.

To add frames, press **[Expand] & [Page ►]** or **[Expand] & [Page ▼]**.

To collapse frames, press **[Expand] & [Page ◀]** or **[Expand] & [Page ▲]**.

## Scrolling within a Display

By default the page keys will advance/retreat a display by one page per press. However, to scroll through displays you may press the **[Scroll Lock]** key on the keypad. The LED on the button illuminates red when in scroll lock mode.

Scroll lock is a toggle state. When scroll lock is first pressed:

- **[Page ▼]** - scrolls table, spreadsheet and channel views down,
- **[Page ▲]** - scrolls table, spreadsheet and channel views up,
- **[Page ►]** - scrolls table and spreadsheet views right,
- **[Page ◀]** - scrolls table and spreadsheet views left.

## Selecting Displays

When a display is selected, the screen is highlighted in a gold border and the display name (such as “1. Live Channel”) will be in gold as well. When a display is not selected, there is no border and the tab name is gray.

If a display is already open, it can be selected in the following ways:

- Press **[Tab]** to change focus between open tabs in chronological order.
- Press **[Tab] & [n]**, where “n” represents the tab number of the desired tab.
- Press **[Live]** or **[Blind]** to automatically bring Live/ Blind into focus. If there are multiple instances of Live/ Blind, pressing **[Shift] & [Live] / [Blind]** brings the next Live/ Blind tab into focus.
- Double press a record target button (such as **[Preset]** or **[Submaster]**) to either open the associated display or select it if it is already open.

## Zooming Displays

You may zoom in and out on displays. To do this, press and hold the **[Format]** button and scroll the **Level Wheel** to alter the display. Scrolling the wheel up zooms in. Scrolling the wheel down zooms out. Zooming the channel summary display when it is in 100 channel mode is not supported. You can also zoom by holding down the left mouse button and rolling the scroll wheel on a mouse.

## Moving Displays

To move the active display from one monitor to another, press and hold the **[Tab]** key and use the page arrow keys to move the display in the direction of the desired screen. One press of the left or right page keys will move the display to the next screen in that direction. To move it back, press the opposite arrow key.

## Clickable Displays

Several displays have click supported cells. Clicking on a cell will select and place it on the command line. You can click on multiple cells to select a range of items. Double-clicking a row header will select that row and deselect any other rows. In-Cell editing must be enabled in **Setup>Device>Displays**. See [In-Cell Editing \(on page 164\)](#)

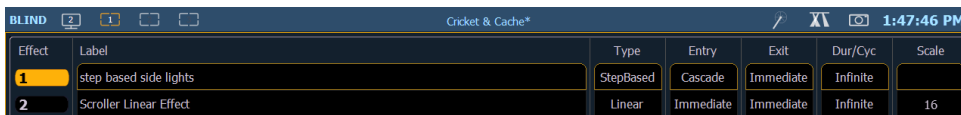

Effect	Label	Type	Entry	Exit	Dur/Cyc	Scale
1	step based side lights	StepBased	Cascade	Immediate	Infinite	
2	Scroller Linear Effect	Linear	Immediate	Immediate	Infinite	16

The following displays have clickable support:

- Show Control List
- Cue List
- Playback Status Display
- Palette Lists
- Sub List
- Preset List
- Effect List
- Group List
- Snapshot List
- Curve List
- Partition List
- Pixel Map List

- Magic Sheet List
- Park Address List
- Patch Display
- Spreadsheet Display
- Macro List

## Quick Access

Quick Access tools are available at the top of each display.



There are three icons:

- Wand - popup magic sheet
- Moving Light Beams - popup moving light controls
- Camera -popup snapshots

### ***Popup Magic Sheet***

This option allows you to view a favorite magic sheet in a small popup window over your current display. The popup magic sheet functions just like a traditional magic sheet and is interactive. .

Press the wand icon to close the display when opened.

A popup magic sheet can be assigned in **Setup>User>Displays>Popup Magic Sheet**. If a magic sheet has not been assigned in Setup, when you first click the popup magic sheet icon, you will be able to select a default magic sheet from a list of the available ones.

In **Setup>User>Displays>Popup Nav Lock**, you can enable or disable the zoom and scroll navigation for popup magic sheets. This option is enabled by default.

See [About Magic Sheets \(on page 398\)](#) for more information

### ***Popup ML Controls***

This option allows you quick access to the ML controls display in a small popup window over your current display. See [Moving Light Controls \(on page 77\)](#) for more information about this display.

Press the moving light beams icon to close the display when opened.

### ***Popup Snapshots***

This option displays your favorite snapshots in a small popup window for quick access. Select a snapshot to recall it. Favorite is an option that can be selected or deselected when recording a snapshot.

Press the camera icon to close the display when opened.

See [About Snapshots \(on page 384\)](#) for more information.

## **[Time] Key**

Holding **[About]** and pressing **[Time]** allows you to view discrete timing data behind any channel parameter. **[Time]** exposes channel or parameter specific timing for any channels in the current cue. The first value is the delay time. If "--" is displayed, there is no delay. The value to the right of the / is the transition time.

You can lock this mode by holding **[About]** and double tapping **[Time]**. When in display time mode, “Display Timing” will display in the upper left of the live display. To exit this mode, press **[About]** again.

## **[Data] Key**

Pressing and holding **[Data]** allows you to view the values behind any referenced or marked data. **[Data]** exposes the next lower reference level. So if you view a palette reference and press **[Data]**, the absolute data will be displayed instead. If you are viewing a preset, absolute or palette data will be displayed, depending on what is contained in the preset.

You can lock this mode by pressing **[Data]** twice. When in display reference values mode, “Data Latched” will display in the upper left of the live display. To exit this mode, press **[Data]** again

## **View Reference Labels**

Pressing and holding **[About]** & **[Label]** toggles the view to show reference labels or numbers depending on what display setting is being used. See [Show Reference Labels \(on page 164\)](#)

## **Live and Blind Displays**

The Live/ Blind display is open as tab 1. This display cannot be closed. Multiple instances of Live/ Blind can be opened.

When in Live, the data displayed represents the data being sent from the console at that moment. In other words, the parameter data that is “live” on stage. When you edit data in live, those changes will become active and visible on stage as soon as the command line is terminated, unless auto playback has been disabled in Setup. See [Auto Playback \(on page 159\)](#) for more information.

When in Blind, the data displayed represents data from the record target you choose to view (cues, presets, palettes, and so on). When you edit data in Blind, changes will not automatically appear on stage, since the data you are modifying is not live.

While in blind, the background color of the displays will be blue, the title bar will be bright blue, and the word “Blind” will display in the top left corner of each monitor. You can click on “Blind” to go back to live.

For more information on Live and Blind, see [Live and Blind \(on page 9\)](#)

## **Using [Format]**

Live / Blind has multiple formats. When first opened, it opens in its default view, which is the [Table View \(on the facing page\)](#). The default view can be set in the [Live and Blind Configuration Menu \(on page 57\)](#). When the default format has been changed, those new settings will be used whenever the display is changed back to that format.

Press **[Format]** to rotate through any available formats.

Live and Blind share formatting. When you change from one format to another format, you are always working with the same format until you change it. The exception to this is [Spreadsheet \(Blind Only\) \(on page 51\)](#), which is only available in blind. If you are working in blind spreadsheet, when you return to live you will be working with the table or summary view, based on which one you were last using.

## **Summary View**

The summary view displays the largest number of channels of any of the formats. This format is best used to see large numbers of channels’ intensity data and/or parameter category data. Individual parameters are not visible in this view.

FCB icons will appear at the bottom of the channel area for channels that have those parameters patched to them. See [Indicators in the Live/ Blind Display \(on page 52\)](#) for more information.



To collapse the summary view, hold down the **[Params]** key and press any parameter category key.

On Element 2, to collapse the summary view, hold down **[Data]** and any of the parameter category key in the **parameter display** (Focus, Color, Image, Shutter, or Form).



When the summary view has been collapsed to show only intensity data, you may include focus, color, or beam data in the summary view by holding down the **[Params]** key and pressing any parameter category key. This displays all categories again. On Element 2, you will need to use **[Data]**.

## Table View

Table view is available in Live or Blind. Unlike summary view, table view displays the fixture type associated with channels and details about each channel's category and parameter levels.

In Live, table view displays all active channel data being output from Eos. In Blind, it will display all data for a single record target (cue, preset, palette) depending on what is viewed. In table view, focus, color, and beam information can be viewed in either a summary of these three categories or an expanded view to show all parameter data.

To expand a category to show detail, press the **[Data]** or **[Params]** key and the associated parameter key. On Element 2, you will need to use **[Data]**. For example, **[Data] [Color]** will change the color category from a summary view to a detailed one. To collapse a category, press the **[Data]** or **[Params]** key and the associated parameter key. You cannot hide a category from view.

When a category has been expanded, to hide or reveal only certain parameters, press and hold **[Data]** or **[Params]** and then select the parameter buttons of the appropriate parameters in the CIA. The parameters will be displayed or suppressed depending on the current view.

Notice that when you hold down the **[Data]** or **[Params]** button, the buttons of parameters that are currently selected for viewing will be highlighted in the CIA.

In the table, a slight space is provided between fixture types, giving a clear delineation between them. The name of the fixture type is displayed at the top of the section for that fixture.

Channels with only intensity parameters will display the same as in summary view.



## Preview Mode in Live

A **{Preview}** softkey is available when in Live Summary.



**Note:** *{Preview}* is not available in Live Table.

**{Preview}** allows you to display the intensity values for another cue under the current values in the Live Summary tab. An indicator of what Preview mode you are in will display in the upper left hand corner of the Live Summary display.

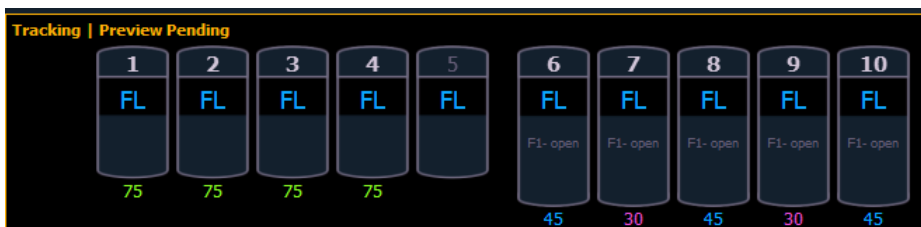

In **{Preview}** mode, the following softkeys are available:

- **{Previous}** - previews the last cue run from the selected cue list.
- **{Pending}** - previews the pending cue from the selected cue list.

The following examples show other functions that are available in Preview:

- **{Preview}[Next]** will allow you to preview the cue higher than the one currently selected. If there is no cue already selected in preview mode, **[Next]** will behave the same as **{Pending}**.
- **{Preview}[Last]** will allow you to preview the cue lower than the one currently selected. If there is no cue already selected in preview mode, **[Last]** will behave the same as **{Previous}**.
- **{Preview}<Cue>[5]** will preview cue 5.

## Channels in Use

To open the Channels in Use display, click on the **{CIU}** icon in the home screen or press **[Tab] & [3][2]**.

Channel	Cuelists	Cues	Moves From 0	Subs	Level
1	6	32	6	2	100
2	6	32	6	4	100
3	6	32	6	4	100
4	6	32	6	4	100
5	5	27	5		100
6	7	43	7	1	100
7	7	43	7	2	100
8	7	43	7	1	100
9	7	43	7	2	100
10	7	43	7	1	100
11	4	25	4	2	100
12	4	25	4	1	100

1 Live Table 28 Faders Page 1 28.2 Faders Page 1 5 ML Controls 4 DS CT 13 Effects 32 Channels In Use +

A Channels in Use display shows the following information for each channel:

- Number of cue lists the channel appears in.
- Number of cues the channel appears in.
- Number of cue moves from zero.
- Number of submasters that channel appears in.
- Maximum channel level.



**Note:** Right-click on the CIU tab to limit see which channels are used with a specified cue list.

## Spreadsheet (Blind Only)

Spreadsheet format is available only in blind mode. It is useful for viewing channel data and trends for multiple cues, submasters, palettes, or presets at one time. Cues/ record targets are displayed on the vertical axis and channel/ parameter data is visible on the horizontal axis.



**Note:** Since this is a blind-only view, changes made in this view are immediate and do not require a record or update.

As with table view, spreadsheet format allows you to choose exactly which parameters you want to view. Parameters can be expanded/ suppressed by holding **[Params]** or **[Data]** and pressing the desired parameter buttons in the CIA. Category data is not available in spreadsheet, but you may hide all parameters of a specific category by holding **[Params]** or **[Data]** and pressing the desired parameter category button. On Element 2, you will need to use **[Data]** .

To toggle between viewing just the intensity information and other parameters, press **[Shift] & [Format]**.

The label column can be hidden by checking the Suppress Target Labels option in the Live and Blind configuration menu. For more information, see [Live and Blind Configuration Menu \(on page 57\)](#)

Channels

Cue	Label	Channels									
		1	2	3	4	5	6	7	8		
1		Intens	Intens	Intens	Intens	Intens	Intens	Scroller	Intens	Scroller	Intens
2	scene1	30	30	30	30		40	F1- open	40	F1- open	40
3	scene2	FL	FL	FL	FL		30	F1- open	30	F1- open	30
4	scene3	75	75	75	75		45	F1- open	30	F1- open	45
5	fun stuff	30	30	75	30	30	10	F1- open	10	F1- open	10
6	cool stuff	IP 2	FL	IP 2	IP 2	0	IP 4	CP 2	IP 4	CP 2	IP 4
7	blue blinder	0	0	0	0	-	IP 3	CP 1	IP 3	CP 1	IP 3
8	jets	-	-	-	-	-	IP 3	CP 1	IP 3	CP 1	IP 3
9		0	0	0	0	0	0	CP 1	0	CP 1	0

## Indicators in the Live/ Blind Display

Eos relies on many traditional ETC indicators which you may be familiar with, as well as some new ones. This section identifies the conventions used in Eos to indicate conditions to you.

This is the Live/ Blind summary view. Please note examples of **color** and **text** indicators in the following graphic:

1	2	3	4	5	6	7	8	9	10	11	12	13	14	15	16	17	18	19	20	21	22	23	24	25
FL	FL	FL	FL	FL	FL	FL	FL	FL	FL	FL	FL	FL	FL	FL	FL	-	FL	-	-	85	85	50	80	80
26	27	28	29	30	31	32	33	34	35	36	37	38	39	40	41	42	43	44	45	46	47	48	49	50
FL	55	-	80	80	80	80	-	-	-	-	-	-	-	-	FL	FL	FL	-	Pr 129	Pr 129	Pr 129	Pr 129	Pr 129	
51	52	53	54	55	56	57	58	59	60	61	62	63	64	65	66	67	68	69	70	71	72	73	74	75
50	50	50	50	50	50	50	50	50	50	FL	70	70	70	FL	70	70	70	70	70	70	75	75	75	75
76	77	78	79	80	81	82	83	84	85	86	87	88	89	90	91	92	93	94	95	96	97	98	99	100
75	75	75	75	75	FL	FL	FL	FL	70	70	70	70	70	70	70	70	70	-	-	-	-	-	FL	FL
101	102	103	104	105	106	107	108	109	110	111	112	113	114	115	116	117	118	119	120	121	122	123	124	125
FL	FL	FL	50	50	50	FL	50	IP 1	IP 1	IP 1	IP 1	IP 1	FL											
								CP 301	CP 301	CP 301	CP 301	CP 301	CP 301											



**Note:** The color and text conventions apply regardless of the format of Live/ Blind being used (see [Using \[Format\] \(on page 48\)](#)).



**Note:** When manual channels are used, there will be an advisory that says "Manual Channels" in red in the upper left hand corner of any Live display.



Most of the channels in the above image are conventional channels (intensity is the only available parameter).

Several channels in the image are moving lights (possessing more parameters than just intensity).

### ***Conventionals***

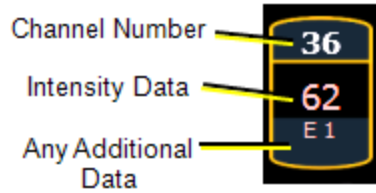

Conventions display only the top field, intensity, as no other parameters are available on a conventional channel.

### ***Moving Lights or Multi-parameter Devices***

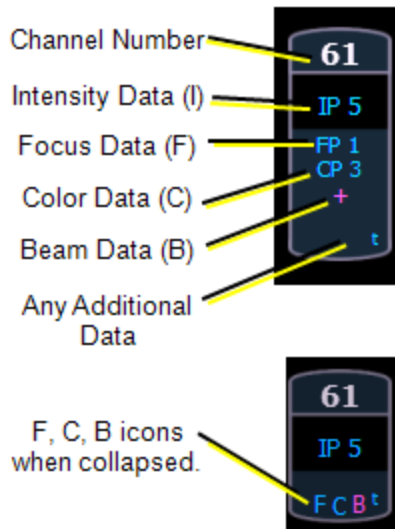

This view also has additional data fields beneath intensity (F, C, B). This information can be suppressed by pressing **[Params]** and any parameter category (Focus, Color, or Beam) in the CIA. Doing so will leave only the intensity field and FCB indicators at the bottom of the channel.

## Multicell Devices

	Master Channel	Cells			
Channel Number	501	.1	.2	.3	.4
Intensity Data (I)	75	FL	FL	FL	FL
Focus Data (F)		+	Orange BP 1	Orange BP 1	Orange BP 1
Color Data (C)		BP 1			
Beam Data (B)		t	t	t	t
Any Additional Data					

	505	.1	.2	.3	.4	.5
	FL	50	50	50	50	50
Indicates that the Master has parameters.	+					
	+	+	+	+	+	+
	+					

Parameter data can also be suppressed in the same way as moving lights.

	501	.1	.2	.3	.4
	75	FL	FL	FL	FL
F, C, B icons when collapsed.		CB	CB	CB	CB

You can use flexichannel modes to hide cells or master channels. See [Using Flexichannel \(on page 59\)](#) for more information.

When in Flexi Cells Off mode, the master channel will display its own information in the normal font size, and data indicators will be used for the cells. If all of the cells are at the same value, that value will display. If the majority of the cells are at the same value, that value will be displayed with a superscript plus sign. If there is not a majority, just a plus sign will be used.



**Note:** A decimal will display at the end of a master channel when flexi cells off is on.

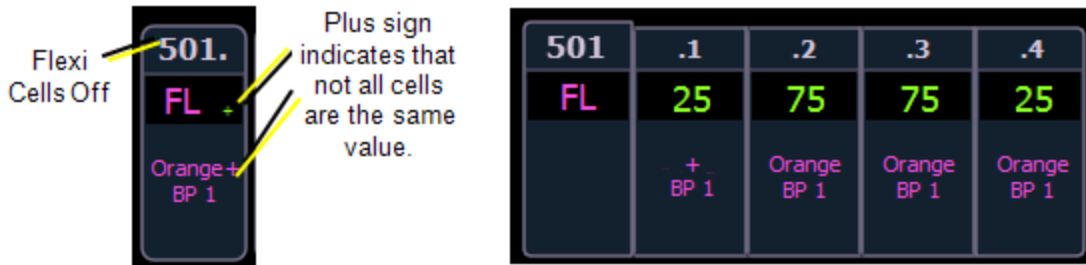
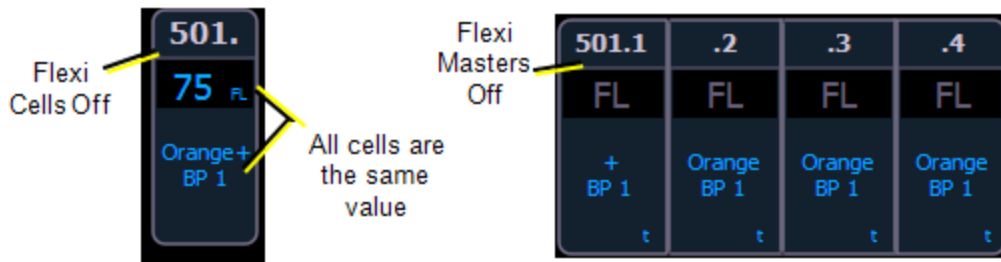

When using Flexi Cells off in table view, plus signs are also used to indicate a difference in the cells.

ColorSrc Linear DB 4 Cell 5ch MC		Color				Beam		
Ch	Intens	Red	Green	Blue	Hue	Saturatr	Shutter Strobe	Strobe M
500.	FL	100	100	100			0	Open
501.	FL +	Orange+	Orange+	Orange+			BP 1	BP 1
502.	FL	+	100	100			0	Open
503.	FL	100	100	100			0	Open

## Color Indicators

Eos uses color to indicate the selection state and information about channel/parameter levels.

### Channel Numbers/ Channel Headers



Unpatched Selected Unselected Deleted

- **Gray number** Unpatched channel number.
- **White number** Selected channel number.
- **Bright White number** Channel is parked.
- **Gold number** Channel is captured.
- **Gold outline** Selected channel.
- **Number with no graphic** Deleted channel.

## Channel/ Parameter Levels

- **Bright Red** Manual Data (any data that has been set but not yet stored to an active cue or submaster) on all consoles using the same user ID. When manual channels are used, there will be an advisory that says "Manual Channels" in red in the upper left hand corner of any Live display.
- **Dark Red** Manual Data (any data that has been set but not yet stored to an active cue or submaster) from other consoles that are using different user IDs.

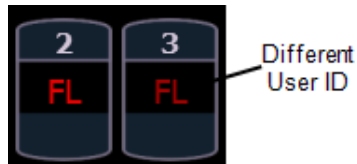

- **Blue** The intensity value is higher than in the previous cue. Non-intensity parameters (NPs) are in blue when any move instruction has occurred. Unmarked.
- **Green** The intensity value is lower than in the previous cue. Also used in reference marking to indicate a channel is marked.
- **Magenta** Value is unchanged from the previous cue (tracked).
- **White** The value is blocked.
- **White with an underscore** Value is auto-blocked.
- **Gray** Default or the value is a null value (from either **{Make Null}** or a filter). When nulled, a gray "n" appears next to the value.
- **Yellow** Data set from a submaster.



**Note:** When data is in transition (moving), it will appear in a lighter version of its color. This includes up/down fades for intensity, non-intensity moves from cues, submaster, and timed manual changes.

## Text Indicators in Live/Blind

Text indicators are used to show additional channel data.



**Note:** Color indicators also apply to text indicators. For example, red indicates a manual value that must be stored. See [Color Indicators \(on the previous page\)](#)

- Underlined value (white) indicates a system-applied block (also called an auto-block).
- + Found in place of parameter data in summary view. Indicates that not all parameters in that category are at the same value. This indicator is found only in the summary view or in table views when the parameters are collapsed into a category view. If a majority of the values are the same, that value will be displayed along with the indicator. If there is no majority, just the indicator will be displayed.
- ! Indicates an ACN, RDM, or dimmer warning.
- ? Indicates an ACN, RDM, or dimmer error.
- **A** Indicates the channel or parameter is asserted.
- **B** Indicates the channel or parameter is manually blocked. This block must be stored.
- **C** Captured channel if in yellow. Color Path if in any other color.
- **I** Channel is controlled by an inhibitive submaster. When displayed in the Block flag, "I" indicates a cue level intensity block.

- **IP, CP, FP, BP** Indicates that the value is referenced to a palette (Intensity, Color, Focus, or Beam). This text is followed by a number, indicating which palette is being referenced. This can be substituted with the palette label if the “Show Reference Label” setting is activated (see [Show Reference Labels \(on page 164\)](#)). Holding down **[About] & [Label]** will toggle between the palette label and palette number.
- **M** Indicates a mark is placed, but manual, and must be stored. Is blue when stored. “m” indicates cue is not marking.
- **MK** Indicates the channel is marked for a later cue. The cue number is indicated in the other categories (see “Q” below).
- **ND** Indicates that a channel has been patched as a non-dim fixture type.
- **N** Indicates the value is null (from either **{Make Null}** or a filter).
- **P** Indicates the channel is parked.
- **Ph** Indicates the channel is at a preheat level.
- **Pr** Indicates that the value is referenced to a preset. This text is followed by a number, indicating which preset is being referenced. The preset label may also be shown if this setting is enabled (see [Show Reference Labels \(on page 164\)](#)). Holding down **[Shift] & [Label]** will toggle between the preset label and preset number.
- **Q** Found in the non-intensity categories of a marked channel. The “Q” is followed by a number indicating which cue the mark is in preparation for.
- **t** The channel has discrete (parameter/category-specific) timing.
- **S** Indicates that a channel is stored to a shielded submaster.
- **R** Indicates a manual reference override. Manual changes have been made that override a previously stored reference (such as to a palette or preset). Once recorded, the reference will be broken. If updated, the referenced target will be updated as well, unless otherwise instructed.

## Live and Blind Configuration Menu

The Live/ Blind displays have a configuration menu. The configuration settings are available by selecting the display tab and then double clicking on the tab to open the menu. With the Live/ Blind display selected, you can also select the gear icon, which is located to the left of the tabs, to open the configuration menu.



**Note:** Each instance of Live/ Blind may be configured individually.



The following options are available:

- **Suppress Target Status Bar** - Hides the target status bar from the display. The target status bar displays at the bottom of the Live/ Blind displays.



- **MC Line Wrap** - When enabled, this option keeps all of the cells together of a multicell fixture when viewing it in Live summary view instead of breaking them up across multiple rows.
- **Suppress Target Labels** - Hides the Label column in Blind spreadsheet view.
- **Show Reference Labels** - When enabled, referenced record targets (such as presets or palettes) with labels will have their labels displayed rather than their target type and number. This setting will only affect the selected instance of Live/ Blind. There is an option in setup, which determines the default that will be used when tabs are opened. It is modified from there in the configuration menu. See [Show Reference Labels \(on page 164\)](#).



**Note:** *[About] & [Label] can be used to temporarily toggle between views.*

- **Group Channels By 5** - When enabled, five channels are grouped together with space separating each group of five. This setting is enabled by default.
- **High Contrast** - When enabled, high contrast brightens the magenta used to show tracked values. This setting is enabled by default.
- **Disable 100 Channel Display Mode** - By default, 100 channels are displayed at a time in the live summary view.
- **Enable 100 Channel Display Mode - 5x20** - This is a variation of the 100 Channel Display Mode, which displays 5 rows of 20 channels.
- **Enable 100 Channel Display Mode - 4x25** - This is a variation of the 100 Channel Display Mode, which displays 4 rows of 25 channels.

## Default

You can save your settings as a default state for Live/Blind. The default is identified with parentheses.

- **Reset to Default** - Will restore the settings to the default state. Live/ blind tabs will normally default to the settings for Tab 1.0, if no other tab has been assigned as default.
- **Set Current as Default** - Allows you to set a Live/ Blind tab other than 1.0 as the default. The default tab will be shown in parentheses , for example (Tab 1).

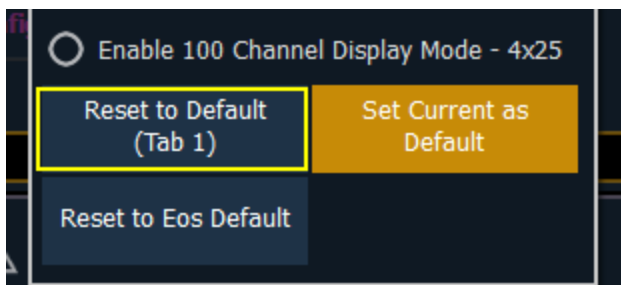

- **Reset to Eos Default** - Restores the settings to Eos defaults.

## Using Flexichannel

Flexichannel (use of the **[Flexi]** key) allows you to view only channels meeting a certain criteria in the Live/ Blind display, therefore removing unwanted data from view. Press and hold **[Flexi]** to see and select from a list of available states and modes in the CIA. You can also press **[Flexi]** multiple times to cycle through the list of available states.

Flexichannel has several available states which include allowing you to view only:

- All channels
- All patched channels
- Manual channels
- All show channels (any channels that have data stored in a cue or submaster)
- Active channels (channels with intensity above zero or a move instruction)
- In Use Channels (channels with intensities that are above zero or fading to zero, running effects, non-intensity moves, or marking.)
- Selected channels
- Channels with discrete timing

There are three Flexichannel modes, which can be used along with the Flexichannel states:

- Cells off (displays only the master channels for multicell fixtures. Master channels will display with a "." after the channel number to indicate that they have cells hidden.)
- Masters Off (displays only the cells for multicell fixtures)
- Partitioned (displays only those channels defined in the current partition)



**Note:** *The multicell fixture views can be used in combination with other flexichannel states.*

---



**Note:** *You can use **[Flexi]** & **[.]** to quickly toggle cells on and off.*

---

In flexi, selected channels (including the last channel selection) are always included in the view. Gaps in channel numbers are indicated by a vertical line between the channels where a gap in numbering occurs.

To change flexi states in the Live/Blind display, press **[Flexi]** to cycle through the views listed above. When **[Flexi]** is held down, the softkeys change to represent all of the available flexi states and modes. You can select the desired flexi view from those keys.

**[Next/Last]** can be used to select the next or last channel in the current flexi state.

**[Thru]** can be used to view only channels in the current flexi state (except for selected channels) as long as either the first or last channel in the **[Thru]** range is included in the current flexi state. To include channels not in the current flexi state, **[Thru] [Thru]** can be used.

### View Channels

You may select specific channels to appear in another flexichannel state called "View Channels". This state does not exist until you select channels to view. After view channels is activated, it will appear in the rotation of flexichannel states when **[Flexi]** is pressed.

**To select channels to view:**

1. Select channels on the command line (do not press **[Enter]**).
2. Press and hold **[Flexi]**.
3. Press **{View Chans}**. The "View Channels" flexi state will be created and the channels you selected will be visible in it.

The channels you selected will be visible in this flexi state until you select other channels and press **{View Chans}** again. At any time, you can access the last channels you defined for this state by pressing **[Flexi]** until this state is visible.

To redefine the selected channels in the state, simply follow the steps above again.

### ***Flexichannel with Timing***

You may also engage the “channels with timing” flexichannel state by pressing **[Flexi] & [Time]**. This will display all channels that have discrete timing in the current cue and will remove channels without discrete timing from view.

You may still hold **[Time]** on Eos or double press **[Time]** on Eos Ti and Gio to view the discrete time behind any parameter or category.

The display will remain in this state until you disengage it by pressing **[Flexi]** again.

### **About & Display Toggles**

While in Live/Blind, you can use the **[About]** key to view additional information.

When in an **[About]** mode, the mode type will display in the upper left hand corner of the Live/Blind display.

The following is a list of the **[About]** modes available in the Live/ Blind displays:



**Note:** Hold **[About]** and double tap the modifier key to latch the mode.

---

- **[About] & [Live]** - displays the DMX levels.
- **[About] & [Data]** - displays the background level information.
- **[About] & [Park]** - displays the parked levels.
- **[About] & [Part]** - displays the cue part number for each parameter.
- **[About] & [Cue]** - displays the source target type and number. For cues, the cue list and cue number that contained the last move will display.
- **[About] & [Mark]** - displays the mark cue used by the channels.
- **[About] & [Next]/[Last]** - displays the next cue with that the channels move in or the last cue with that the channels moved in.
- **[About] & [Label]** - displays the reference labels.
- **[About] & [Time]** - displays the discrete time.
- **[About] & [Path]/[Color Path]** - displays the color paths.



**Note:** To page while in these modes, release the modifier key while keeping **[About]** held down.

---

### **Playback Status Display**

The playback status display (PSD) allows you to view a range of cues in the current cue list, all cue attributes for those cues, and a view of the fader configurations for 10 pages of 10 faders each (for a total of 100 visible faders).

On Element 2, the playback status display (PSD) allows you to view a range of cues in the cue list and all the cue attributes for those cues. Fader information can be viewed in the [fader status display](#) .

The PSD opens on Tab 2. This display cannot be closed, but you can have multiple instances of the PSD open on different tabs.



Holding down **[Time]** (the one by **[Data]**), while a cue is fading, will display the cue category times counting down in the cue list display area. The default action is to show the total time not the countdown.

To always show the countdown, a **{PSD Time Countdown}** option is available in PSD configuration menu (see [Playback Status Display Configuration \(on page 66\)](#)). When the **{PSD Time Countdown}** is enabled, the cue category times will countdown as a cue is fading. To see the total time, hold down the **[Time]** key. **{PSD Time Countdown}** is “disabled” by default.

An optional command line for the playback status display is available. The optional command line must be enabled to use. See [Playback Status Display Configuration \(on page 66\)](#).

There are three formats for the playback status display on all consoles except Element 2:

- [Expanded Cue List Format \(on the next page\)](#)
- [Split Playback Status Display \(on page 63\)](#)
- [Fader Display Format \(on the next page\)](#)

By default, it will be an expanded cue list format. When the focus is on the playback status display, press **[Format]** to toggle between the formats.

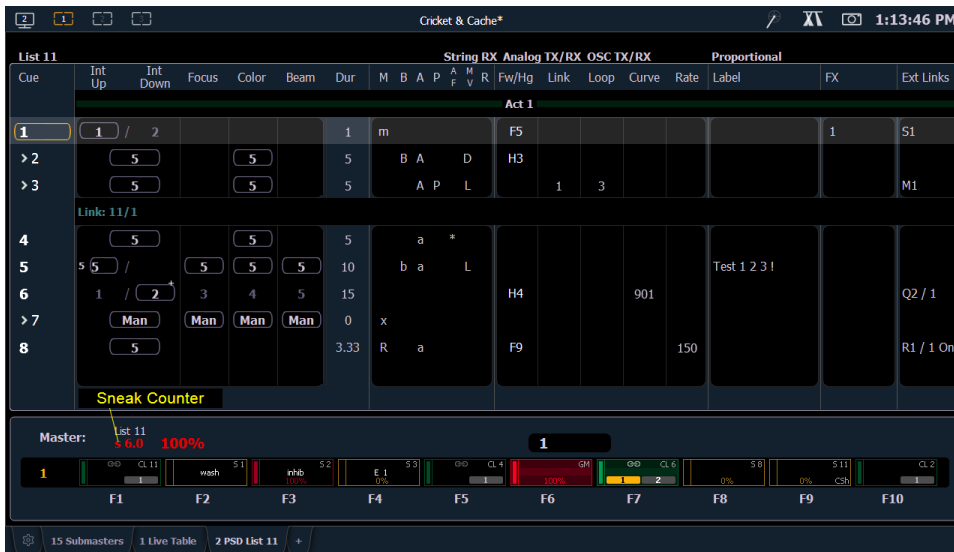

On Element 2, the PSD looks like:

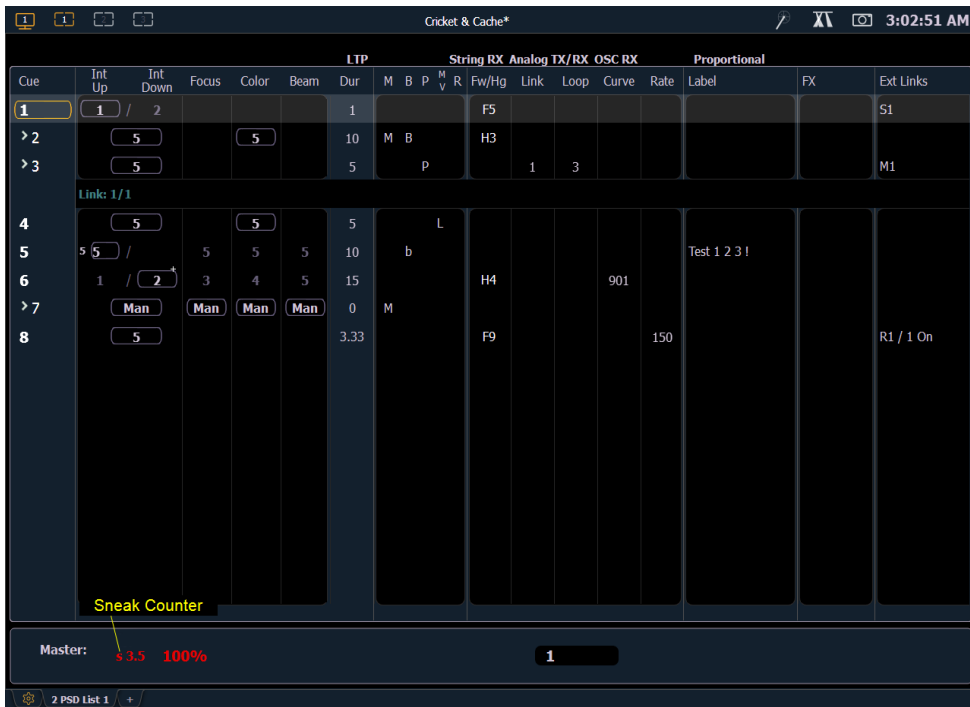

## Expanded Cue List Format

Pressing [Format] with the playback status display active will access this format. In expanded cue list, the view of the active cue list increases to the full size of the display. The current fader page is visible at the bottom of the screen.

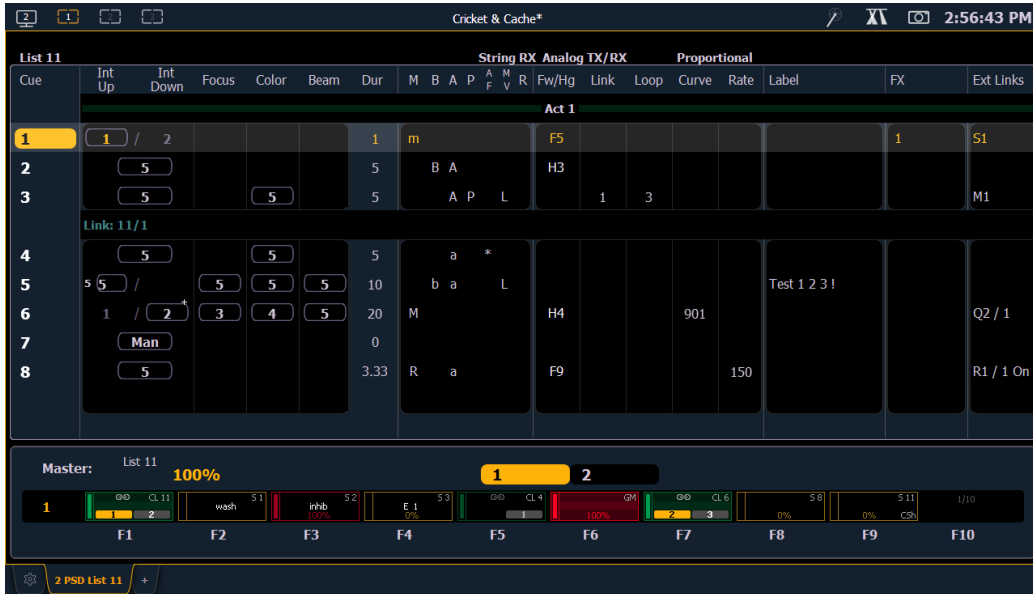

## Fader Display Format

Pressing [Format] with the playback status display active will access this format, which shows a view of the fader configurations for 10 pages of 10 faders each (for a total of 100 visible faders).

Each fader is color coded based on its assigned target type. Grandmasters and inhibitive submasters are in red, additive submasters are yellow, playback faders display in green, and presets and palettes are orange.

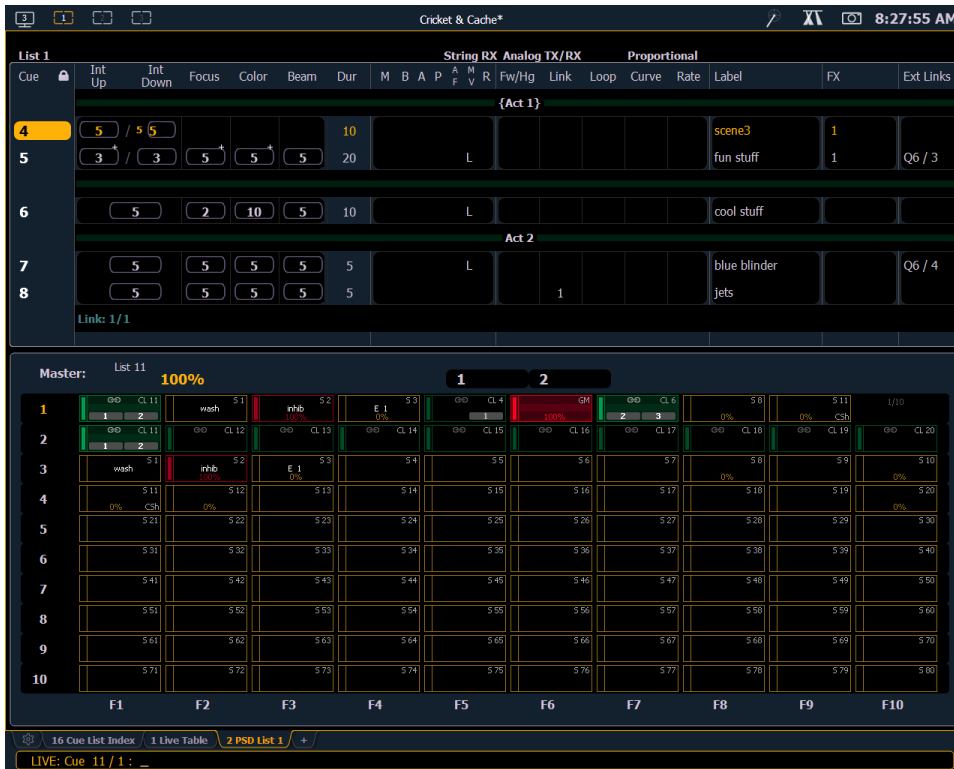

## Split Playback Status Display

Pressing [Format] with the playback status display active will access this format. With the playback status display split, two different cue lists can be displayed at the same time. This is set in the configuration menu (see [Playback Status Display Configuration \(on page 66\)](#) for more information).



**Note:** The first time you access the split playback status display, you may need to adjust the splitter bar between the two lists to see the second list.

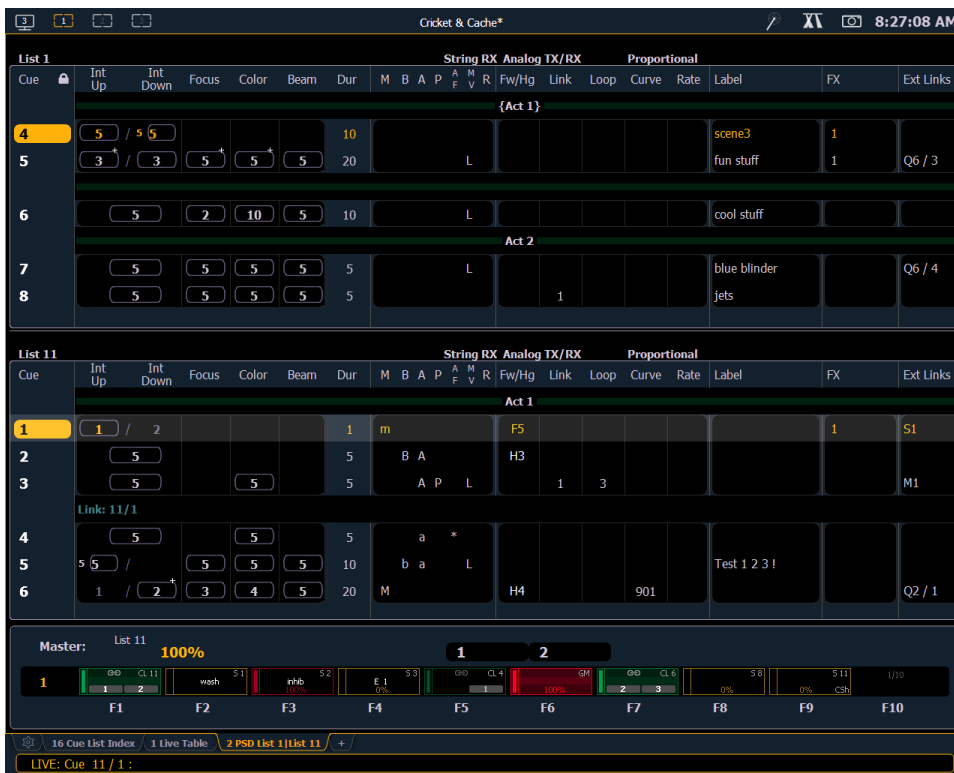

## Paging the Playback Status Display

[Page ▲] or [Page ▼] will page the display up or down.



**Note:** To page the Playback Status Display (PSD) if focus is on a Live/Blind tab, use [Shift] & [Page ▲] or [Shift] & [Page ▼].



**Note:** This action will page the PSD that is showing the currently selected cue list. If there is no PSD visible showing that cue list, nothing will be paged.

## Indicators in the Playback Status Display

Eos relies on many traditional ETC indicators which you may be familiar with, as well as some new ones. This section identifies the graphical and colorful conventions used in Eos to indicate conditions to you.



## Color indicators

### Cue List

- **Gold** - Any item (cue, list, page) highlighted in gold indicates “current”. Outlined in gold indicates “selected”.
- **Red** - Cue fade is in progress

### Fader Ribbon / Display

- **Red** - Grandmasters and inhibitive submasters
- **Yellow** - Additive submasters
- **Green** - Playback faders
- **Orange** - Presets and palettes

### Text indicators

- **+** (see cue 6) - Indicates that there is discrete timing within the associated cue. Found in the cue display “Timing” area.
- **\*** (see cue 4) - Indicates the cue has an allfade command. Found in the cue display “Flags” area.
- **\* -** Indicates a link to a non-existent cue. Found in the cue display “Link” area.
- **D** - Indicates a dark move, a cue that has any non-intensity parameters moving on channels whose intensity is at 0. Found in the cue display “Flags” area in the move column.
- **x** - Indicates that a mark has been placed, but the mark is broken.
- **A or a** (see cues 3 & 4) - Indicates an asserted cue. “A” indicates the entire cue is asserted. “a” indicates a channel or parameter assert only. Found in the cue display “Flags” area.
- **B or b** (see cues 2 & 5) - Indicates a blocked cue. “B” indicates the entire cue is blocked. “b” indicates a channel/ parameter block only. Found in the cue display “Flags” area.
- **F1 - F10** - Indicate faders numbered 1 through 10 on the console. Found at the bottom of the fader display.
- **F5** (see in cue 1) - Indicates a follow time associated with the cue (in this case, 9 seconds). Found in the cue display. Notice the arrow on Cue 2.
- **H3** (see cue 2) - Indicates a hang time associated with the cue (in this case 4 seconds). Found in the cue display. Notice the arrow on Cue 3.

- **I** - Indicates an intensity blocked cue. Found in the cue display “Flags” area.
- **L** - Indicates a live move. A “+” is used to show that both types of moves are in that cue.
- **M or m** (see cue 1) - Indicates a marked cue. “M” indicates an AutoMark or a reference mark that is used by a subsequent cue. “m” indicates a reference mark that is currently unused by any subsequent cue (see [About Mark \(on page 216\)](#)). Found in the “Flags” area.
- **P** (see cue 3) - Indicates the cue will preheat. Found in the cue display “Flags” area.
- **R** (see cue 8) - Indicates the source cue which refers back to an earlier mark (see [Referenced Marks \(on page 217\)](#)). Found in the cue display “Flags” area.
- **Number in the FX column** (see in cue 1) - Indicates a cue level effects override.
- **M1**(see in cue 3) - Indicates a linked macro.
- **Q2/1** (see in cue 6) - Indicates a linked cue.
- **S1** (see in cue 1) - Indicates a linked string. The string will display here.
- **Relay 1/1** (see in cue 8) - Indicates a linked relay.



**Note:** The playback status display will show a red counter for sneak time.



**Note:** If any show control options are currently enabled in **Setup>System>Show Control**, they will display at the top of the Playback Status Display.

For more details on information contained in the playback status display, see [Playback Status Display \(on page 60\)](#).

## Playback Status Display Configuration

Playback Status Display (PSD) has a configuration menu, which is accessed by double clicking or right-clicking on the PSD tab, or by selecting the gear icon, and clicking PSD.



The following options are available in the PSD Configuration Menu:

- **Target Grid** - this option is only available when the PSD is split, and is used along with the Lock Status option. Target Grid allows you to select either the top or bottom display. Press **[Format]** to split the PSD.

- **Lock Status** - allows you to lock the PSD to a certain cue list. When the PSD is split, you will use Target Grid to first select top or bottom of the display, and then you can use Lock Status to select the cue list.



**Note:** Phantom cue lists will display but cannot be locked to. See [Cue List Properties \(on page 278\)](#) to learn more about phantom cue lists.

- **Display Cue Parts** - displays the individual parts of a part cue. When not enabled, the number of parts for that cue will display as a superscript number beside the cue's number.
- **Display Cue Links** - displays the [Link/ Loop](#) information.
- **Display Scenes** - displays cue [scene information](#).
- **Display Follow/ Hang Indicator** - displays the Follow/ Hang arrow indicator before the cue number of any cue that will be triggered by a follow or hang.
- **Display PSD Time Countdown** - displays the cue category times countdown in the PSD as a cue is fading.
- **Display Master Playback Status** - displays the current cue's status information.
- **Display Fader Ribbon** - displays the fader ribbon, which shows the current fader page under the Master Playback Status. Not available on Element 2.

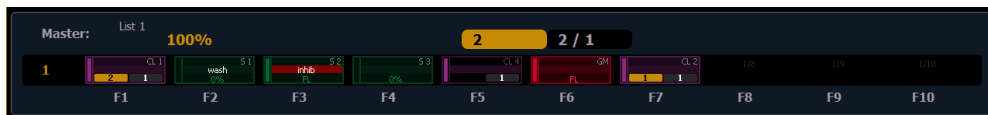

- **Display Notes** - displays the [Cue Notes](#) in a horizontal bar at the bottom of the PSD.
- **Display Pending Cue Notes** - displays the [Cue Notes](#) for the pending cue in a horizontal bar at the bottom of the PSD.
- **Display Command Line** - displays an optional command line on the PSD. Not available on Element 2.
- **Break Link to Live/ Blind** - When selecting the Live/ Blind display, the PSD will also come into view if it is currently hidden. This option allows you to break the link between the PSD and the Live/ Blind displays so that the PSD will no longer come into view when selecting Live/ Blind.

## Reorder Columns

Reorder columns allows you choose what data displays in the PSD and what order it displays in. By default, all columns except notes will be displayed. The arrow keys on the right can be used to move columns around. Columns are moved in groups. To select a column header to move, click or tap the name. The check boxes suppress or enable. When an item is enabled to display, a check mark will be in the corresponding box.

## Default

You can save your settings as a default state for the PSD. The default PSD is identified with parentheses.

- **Reset to Default** - returns the settings to the default state that you created.
- **Set Current as Default** - uses the current settings to create a default state. The default tab will be shown in parentheses , for example (Tab 2).

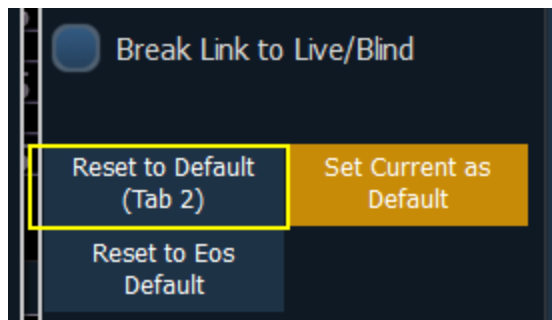

- **Reset to Eos Default** - returns all settings to the Eos defaults.

## Using Direct Selects

Direct selects are buttons that provide quick access to channels and various other targets. Each type of direct select is colored coded.

To open the direct selects, press the direct select icon on the [Workspace Layout Menu \(on page 42\)](#) or use **[Tab] [4]**. Select a direct select type by pressing the corresponding button.

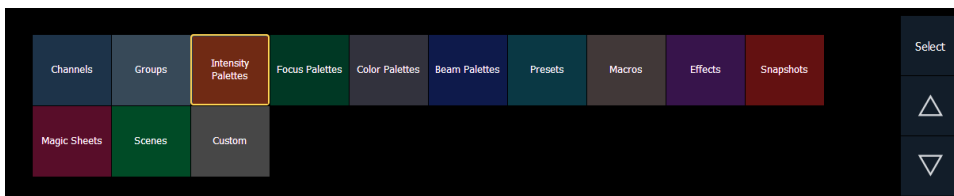

The following is a list of the types of direct selects available and their colors:

- Channels -blue
- Groups - slate
- Intensity Palettes - yellow
- Focus Palettes - forest green
- Color Palettes - gray (A color swatch will display in the lower left hand corner if enabled in the [Direct Selects Configuration Menu \(on the facing page\)](#).)
- Beam Palettes - royal blue
- Presets - aqua
- Macros - brown
- Effects - purple
- Snapshots - red
- Magic Sheets - magenta
- Scenes - green
- Custom - light gray

If there are more items than can be viewed at once, you may view subsequent pages by using the page touchbuttons (**{▲}**, **{▼}**) by the direct selects. Hold a page button down and type a number to jump to a specific direct select.

When storing to direct selects (groups, palettes, presets, and so on), you may store directly to them by pressing **[Record] {Direct Select Key}**.

When the direct select is chosen and on the command line, it will have a gold border around it. If content is available for selected channels, the tile is highlighted. An unrecorded direct select will have a dark background with dark gray text.





**Note:** To adjust the brightness of the direct selects, use the Color Brightness fader in Setup. When the fader is set to 0, the color coding is removed. See [Direct Selects Brightness \(on page 166\)](#) for more information.

You can record decimal inserts to a direct select ({Group 7.1}, {Color Palette 15.5}, {Preset 6.94}, and so on). Use the {Increment} setting in the [Direct Selects Configuration Menu \(below\)](#) to set how the numbers will display.

### Example:

Assume you have stored color palette 1 (button 1), color palette 1.1 (button 2), and color palette 3 (button 3). If you record color palette 2, it will appear in the slot just after color palette 1.1 and color palette 3 will be bumped one slot to the right. This will continue until an open slot can absorb the displaced target.

To change the direct select type, press the {Select} button. See [Direct Selects Configuration Menu \(below\)](#) for more information about the {Select} button.

## Direct Selects Configuration Menu

You have considerable flexibility in how you organize the direct selects by using the options in the configuration menu.

To access the configuration menu, right click or tap on the direct select's tab to see the configuration menu.

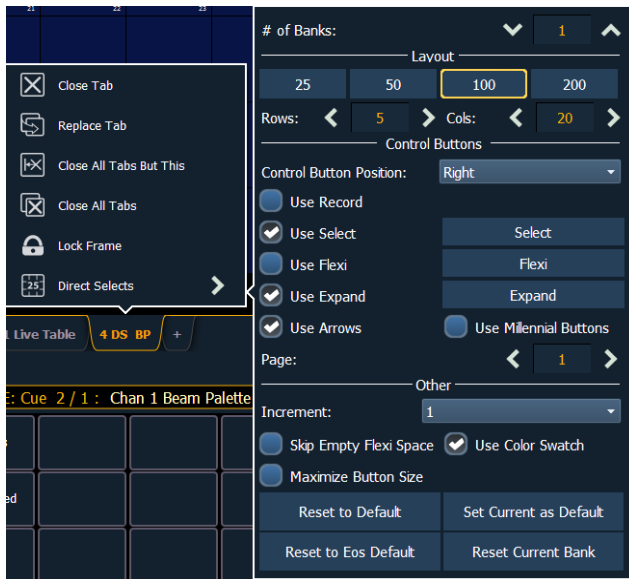

The following options are available:

- **# of Banks** - sets the number of direct select banks that will display.

### Layout

- **25, 50, 100, 200** - allows you to select the number of buttons that will display per bank.
- **Rows** - allows you to select the number of rows in the banks.
- **Columns** - allows you to select the number of columns in the banks.

## Control Buttons

- **Control Button Position** - allows you to set if the control buttons will display on the left side or the right side of the banks.
- **Use Record** - displays the **{Record}** button. The **{Record}** button posts Record to the command line.
- **Use Select** - displays the **{Select}** button. The **{Select}** button will display the selected direct select type. Pressing it will allow you to select a different direct select type.
- **Use Flexi** - displays the **{Flexi}** button. See [Direct Selects in Flexi Mode \(on page 73\)](#)
- **Use Expand** - displays the **{Expand}** button.
- **Use Arrows** - displays the page up and down arrows.
- **Use Millennial Buttons** - displays the century and millennial buttons. These buttons allow you to jump to pages in the hundreds and thousands.
- **{Page}** - displays the selected page of direct selects.

## Other

- **Increment** - allows you to select if the direct select buttons will display as 1 (whole numbers), .1 (tens), .01 (hundreds).
- **Skip Empty Flexi Space** - will display a vertical bar instead of empty space between a range of buttons when in Flexi mode.
- **Use Color Swatch** - displays a triangular color swatch in the lower left corner of a color palette direct select.



- **Maximize Button Size** - sets the size of the direct select buttons to fill the available space. This is similar to Fit to Screen in previous versions of software.
- **Reset to Default** - will restore the settings to the default state. If no default state has been set, the Eos default settings will be used.
- **Set Current as Default** - allows you to set the current settings to be used as a default state.
- **Reset to Eos Default** - restores the settings to Eos defaults.
- **{Reset Current Bank}** - restores the settings of the current bank.

## Custom Direct Selects

**{Custom}** allows you to select multiple targets to display in the same bank of direct selects.

### Assigning Targets to Custom Direct Selects

After selecting **{Custom}** as the direct select type, the direct selects will first display as being empty. To assign a target to a direct select or multiple direct selects, you can either tap on a direct select to open the configuration window, or you can use the command line.

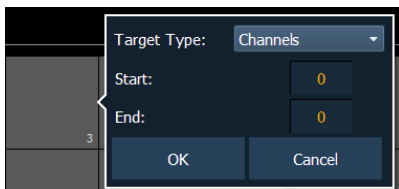

From the configuration window, you can select the target type, and the starting and ending target numbers, which allows you to assign a range of targets.

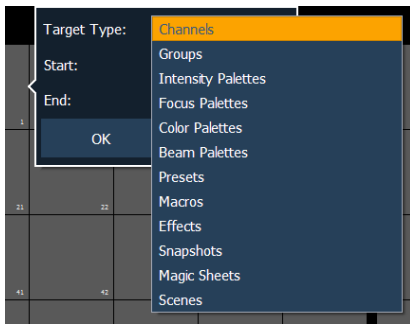

From the command line, you can select a range of targets that you want to assign, such as **[Presets] [1] [Thru] [5] [Enter]**. Then double click on a direct select to assign the selection. A range typed in reverse will be mapped in reverse.

Checking the "Include Non-Existant Whole Number Targets" box allows you to map targets that may not exist yet. If the box is left unchecked, non-existent targets will not be mapped.



**Note:** To assign a range of channels to the direct selects, you will need to use the configuration window. From the command line, you can only assign one channel at a time.

## Scenes on Custom Direct Selects

Scenes can be assigned to custom direct selects. To assign a scene to a direct select, you can either tap on a direct select to open the configuration window, or you can use the command line.

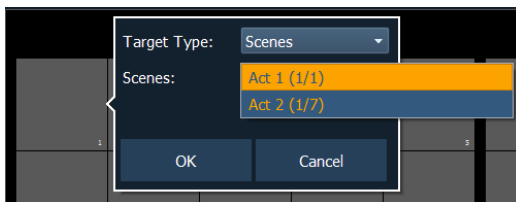

From the configuration window, you can select the target type of scene, and the scene number. Only one scene can be assigned at a time.

From the command line, you can select a scene, such as **[Cue] [1] {Attributes} {Scene} [1] [Enter]**. Then double click on a direct select to assign the selection.

## Clearing Custom Direct Selects

You can clear a custom direct select by using the **[Escape]** key. Hold down the **[Escape]** key and then press the direct select that you want to clear. To clear a range of direct selects, hold down the **[Escape]** key and press the first direct select in the range until a red X appears on it. With **[Escape]** still held down, press the last direct select of the range.



Using **[Reset ALL Monitors and Workspaces]** on the [Workspace Layout Menu \(on page 42\)](#) will also clear all custom direct selects.

## Scenes on Direct Selects

**Scenes** can be selected from the direct selects. From the direct selects display, press **{Select}** and then **{Scenes}** to view your scenes on the direct selects. The direct select will show the scene's label and cue.

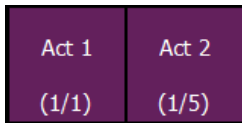

Pressing a scene direct select will post the cue number associated with that scene as a terminated command onto the command line.

Double pressing a scene direct select will fire the cue, if **{DirSelDb1 Clk}** has been enabled in **Setup>Device>Displays**.

To post as an unterminated command, hold down **[Shift]** as you press the direct select.

## Scenes on Custom Direct Selects

Scenes can be assigned to custom direct selects. To assign a scene to a direct select, you can either tap on a direct select to open the configuration window, or you can use the command line.

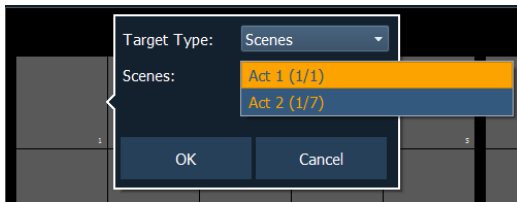

From the configuration window, you can select the target type of scene, and the scene number. Only one scene can be assigned at a time.

From the command line, you can select a scene, such as **[Cue] [1] {Attributes} {Scene} [1] [Enter]**. Then double click on a direct select to assign the selection.

## Selecting Channels with Direct Selects

Channel direct selects are highlighted when selected. Channel selection from the direct selects is an additive process, if channels 1 through 5 are selected, pressing **{Channel 6}** adds channel 6 to the selection, leaving channels 1 through 5 also selected. Pressing **{Channel 6}** again will deselect the channel.

If you have labeled channels in patch, those labels will be displayed above the channel number when viewing channels in the direct selects.

**Note:** *When using the button module, pressing and holding a channel button while pressing another channel button selects those two channels **and** all channels in between. This behavior is not supported when channel selects are used on the touch screens without the module. This applies to Eos consoles only.*

- **{Channel 1}** - adds channel 1 to currently selected channels, if not currently selected.
- **{Channel 1} {Channel 10}** - adds channels 1 and 10 to currently selected channels.
- **{Channel 1} & {Channel 10}** - adds channels 1 thru 10 to currently selected channels (if button modules are used (Eos Only)).
- **{Page ▼}** - pages direct selects down by one page.
- **{Page ▲}** - pages direct selects up by one page.

## Direct Selects in Flexi Mode

Direct selects can be placed into a flexi mode, which will remove empty tiles. **{Use Flexi}** needs to be enabled in the Direct Selects configuration menu. See [Direct Selects Configuration Menu \(on page 69\)](#).

When enabled, the **{Flexi}** button will display in the direct selects display.

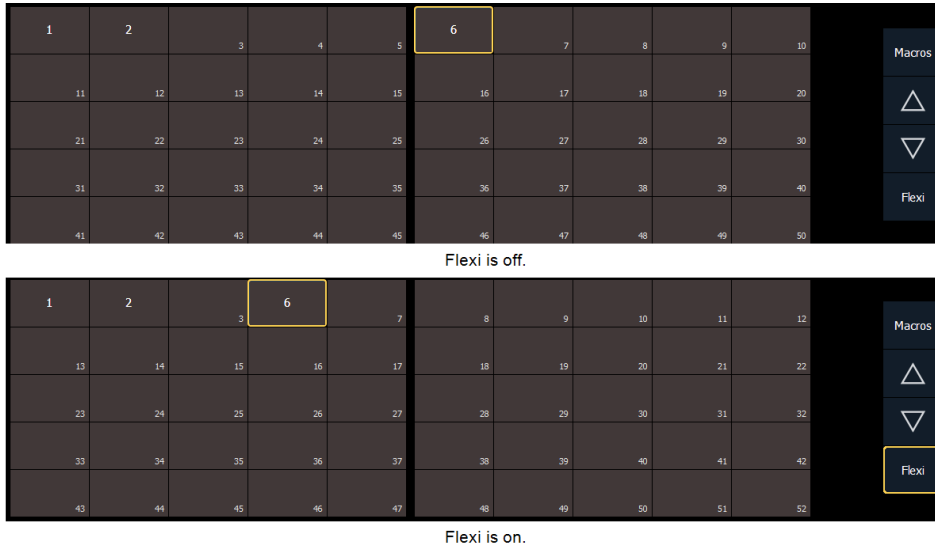

When in flexi mode, the **{Flexi}** button will be outlined in gold.



**Note:** A single empty direct select tile may remain if the adjacent direct select tiles are not sequential. This is to allow an easy way to insert a new direct select between the existing ones.

## [Shift] & Direct Select

Selecting record targets from direct selects will terminate the command line. To post a control to the command line without terminating it, hold down **[Shift]** while pressing the direct select. This allows multiple commands to be selected and executed at once, and an optional sneak time to be entered.

## Encoders

The encoders are one of the ways to control the non-intensity parameters (NPs) of multiple parameter devices. For more information on using the encoders, see [Setting Non-intensity Parameters with the Encoders \(on page 176\)](#).

On Eos, the top four encoders are identified by the encoder LCD window, just to the left of the encoders. The bottom two encoders are always in control of pan and tilt respectively from left to right.

On Eos Ti, the top four encoders are identified by the encoder touchscreen, just to the left of the encoders. The bottom two encoders are always in control of pan and tilt respectively from left to right.

On Gio, Gio @ 5, and Ion Xe, the four encoders are identified in two ways, by the encoder controls display and the mini encoder status display.

On Element 2, you can access encoder control by using the ML controls display. See [Moving Light Controls \(on page 77\)](#) for more information.

## Encoder Display on Eos and Eos Ti

The encoder display area will show the name of the parameter it controls, display stepped limits (if any) and also a **{Home}** button which allows you to set that parameter to its default position. You can also home any parameter.

Some buttons that may be available on the touchscreen are:

- Min
- Max
- Next
- Last
- Home
- Mode

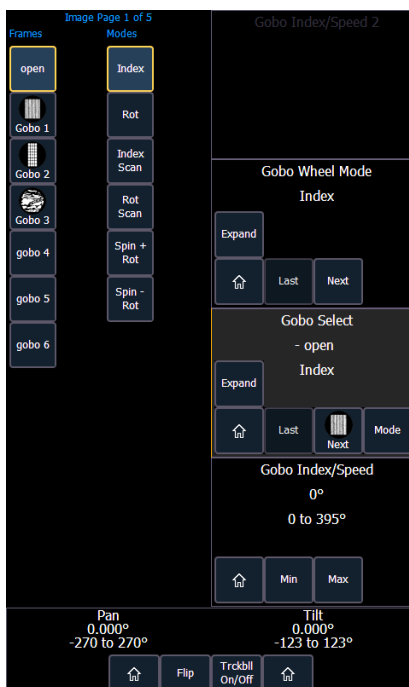

Buttons like **{Next}** and **{Last}** are used to step through ranges (such as colors in a color scroller) one step at a time. **{Min}** and **{Max}** allow you to send a parameter to its minimum or maximum limit with one press.

Modes allows you to switch between modes of a parameter (if any exist); for example, a rotating gobo wheel. If additional modes are available, their softkeys will display near the top of the encoder display.

Encoders can be switched from course mode into fine by holding down **[Shift]** while using an encoder will put it in fine mode for as long as **[Shift]** is held down. Once **[Shift]** is released, the encoder will return to course mode. See [Face Panel \(on page 162\)](#) for encoder options.

Press **{Expand}** to see all of the information about any device with a frame table. Press again to collapse to the normal view. You may make selections from the Expand screen. The colors/images in the device are established in patch (see [Using the Scroller/Wheel Picker and Editor \(on page 116\)](#)).

To the left of the encoder touchscreen are six hardkeys (five on Eos) that are for encoder control. From top to bottom, these encoder paging keys control intensity, focus, color, shutter, image, and form. Pressing any of these will change the parameters controlled by the encoders. To view other available encoder pages, simply press the encoder paging keys to advance the pages.

[Encoder Paging Keys] & [#] will take you directly to a page. [Flexi] & [Encoder Paging Keys] will toggle the flexi encoder states.

To post a parameter category to the command line, use the parameter category buttons.

To post beam to the command line, double press the shutter, image, or form parameter category buttons.

Some fixtures have more parameters than can be displayed on one encoder page. The number of pages for each category is displayed at the top of the encoder touchscreen. To view the other pages, simply press the encoder paging button to advance the pages or hold the button and press a number key to go directly to the page you want to access.

## Encoder Controls Display

The encoder controls display is available on Gio, Gio @ 5, and Ion Xe consoles. Press the [Encoder Display] hardkey to open the encoder controls display.



Directly under the middle two encoders are six hardkeys that are for encoder control. From left to right, these encoder paging keys control intensity, focus, color, shutter, image, and form. Pressing any of these will change the parameters controlled by the encoders.

To view other available encoder pages, simply press the encoder paging keys to advance the pages.

[Encoder Paging Keys] & [#] will take you directly to a page. [Flexi] & [Encoder Paging Keys] will toggle the flexi encoder states. See [Flexi Encoders \(on page 77\)](#) for more information.

To post a parameter category to the command line, use the parameter category buttons located in the CIA.



**Note:** To post beam to the command line, double press the shutter, image, or form parameter category buttons.

---

Each encoder's area will display the name of the parameter it controls, display stepped limits (if any) and also a {Home} button which allows you to set that parameter to its default position.

The encoder controls display allows you to cycle through parameter steps (if available). You can also home any parameter. Some buttons that may be available are:

- Min
- Max
- Next
- Last

- Mode
- Expand

Buttons like **{Next}** and **{Last}** are used to step through ranges (such as colors in a color scroller) one step at a time. **{Min}** and **{Max}** allow you to send a parameter to its minimum or maximum limit with one press.

Modes allows you to switch between modes of a parameter (if any exist); for example, a rotating gobo wheel. If additional modes are available, their softkeys will display at the top of the encoder controls display.

Encoders can be switched from course mode into fine by holding down **[Shift]** while using an encoder will put it in fine mode for as long as **[Shift]** is held down. Once **[Shift]** is released, the encoder will return to course mode.

Press **{Expand}** to see all of the information about any device with a frame table. Press again to collapse to the normal view. You may make selections from the Expand screen. The colors/images in the device are established in patch (see [Using the Scroller/Wheel Picker and Editor \(on page 116\)](#)).

## Mini Encoder Display

On Gio, Gio @ 5, Ion Xe, or ETCnomad using a Programming Wing, information on what the encoders are currently controlling can always be found in the mini encoder status display, even when the [Encoder Controls Display \(on the previous page\)](#) is closed. This display is found above the softkeys in the CIA.

Use the Parameter Category hardkeys to choose which parameters are currently available on the encoders.

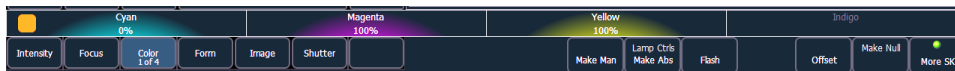

Some fixtures have more parameters than can be displayed on one encoder page. The number of pages for each category is displayed at the bottom of the Parameter Category softkey. To view the other pages, simply press the button to advance the pages or hold the button and press a number key to go directly to the page you want to access.

## Encoder Navigation

Use the encoder page buttons (located to the left of the encoder LCD) to choose which parameters are currently available on the encoders. There are five usable buttons: Color, Custom, Shutter, Image, and Form. Pressing any of these will change the parameters controlled.

Some fixtures have more parameters than can be displayed on one encoder page. The number of pages for each category is displayed at the top of the encoder touchscreen. To view the other pages, simply press the **[Color]**, **[Custom]**, **[Shutter]**, **[Image]**, or **[Form]** button to advance the pages or press the button with a number key to go directly to the page you want to access.

Encoders can be switched from course mode into fine by holding down **[Shift]** while using an encoder will put it in fine mode for as long as **[Shift]** is held down. Once **[Shift]** is released, the encoder will return to course mode.

## Encoders in Blind

The encoders and the level wheel are disabled by default when in the blind display. Pressing an **[Encoder Page Keys]**, for example **[Color]**, will enable the encoders and level wheel. When the encoders are disabled, trackball functionality for pan and tilt will also be disabled.



## Flexi Encoders

In Flexi mode, any empty locations for parameters not applicable for selected channels will be suppressed. By default, the encoder display will be in Flexi mode.

Holding down [Flexi] and an [Encoder Page Keys], for example [Image], can be used to exit or enter Flexi mode.

## Locking the Encoders

It is possible to lock out the encoders. To lock out the encoders, press [Escape] & [Encoder Page Keys]. To unlock, press any of the [Encoder Page Keys].

## Moving Light Controls

A display tool for controlling the non-intensity parameters (NPs) of multiple parameter devices is the ML Controls. The ML Controls are on Tab 5.

On Element 2, the display can be opened in the CIA by pressing the [ML Controls] button.



**Note:** A popup window version of the ML Controls can be opened for quick access of these controls. See [Popup ML Controls \(on page 47\)](#)

You will need to have a multi-parameter device selected to properly view this display. The display will change based on the device selected. If you have a device that only has intensity and color parameters, the ML Control display will only show intensity and color parameters.



**Note:** Controls available in this display will change based on the fixture selected.

When there is room, multiple rows of parameters will display, and you can scroll the display vertically.

There are category shortcut keys on the left side of the ML Controls display. Press a key to quickly access those controls.

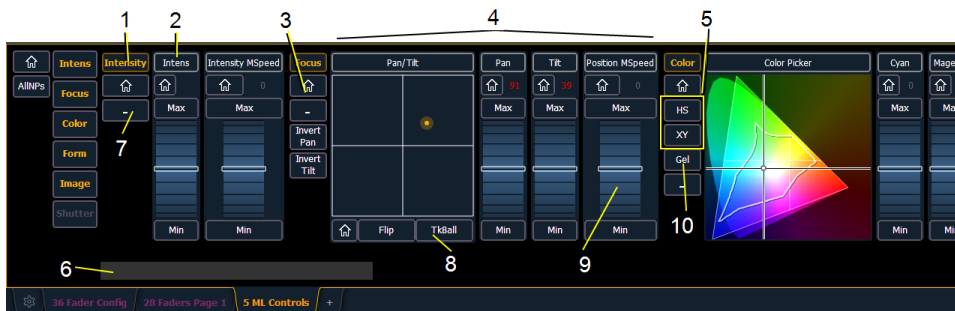

1. Category button (Clicking this button will put the category on the command line.)
2. Parameter button (Clicking the button will put the parameter on the command line.)
3. Home button allows you to home a specific parameter or attribute of a parameter.
4. Parameter attributes
5. Selects the color picker.
6. Scroll through a fixture's available categories.
7. Collapses or expands categories.
8. Gives pan and tilt functionality to a mouse or trackball.

9. Virtual encoder (Click and hold close to the center line for slow movement, further away for faster movement.)
10. Opens the gel picker.

## Fader Configuration

The fader configuration display is found on Tab 36 .The [Fader List \(on page 80\)](#), which shows all of the faders and their assignments, can be found in Tab 35.

At the top of the fader configuration display, you can select the fader page, which has 100 pages of 10 faders each page.

You can configure the master fader pair at the top of the display. See [Master Fader Configuration \(on page 82\)](#) for more information.

The fader configuration display shows a virtual mockup of each fader and its buttons. The various parts of the virtual fader can be clicked or tapped to open configuration options.

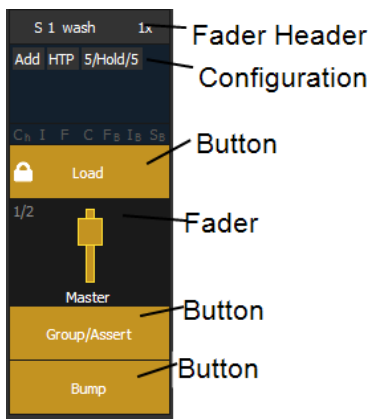

Each fader is color coded based on its assigned target type. Grandmasters and inhibitive submasters are in red, additive submasters are yellow ,playback faders display in green ,and presets, palettes, global effects, and manual time masters are brown.

On Element 2, playback faders cannot be assigned.



## Fader Configuration Window

Click on the fader header to open the fader configuration window.

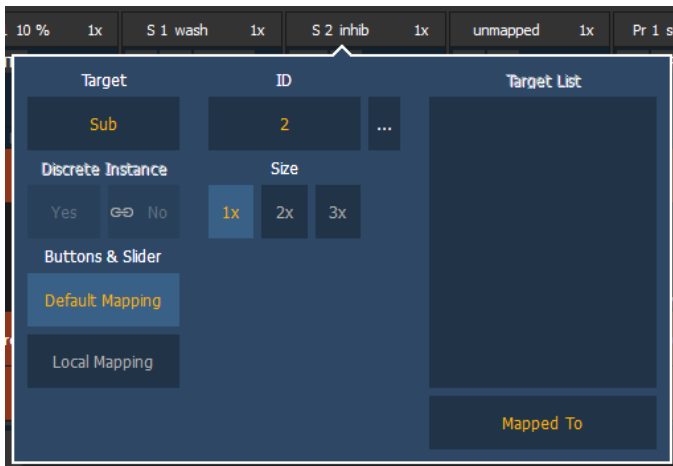

## Target

This setting allows you to map a cue list, submaster, intensity, focus, color, or beam palette, preset, global effect fader, manual time master, or grandmaster to a fader.

## ID

This sets the number of the target assigned to the fader, such as Cue List 2 or Submaster 5. For a list of available Target IDs, click or press the {...} button beside ID.



**Note:** Content can also be loaded to faders from Live, using the command line and load.

## Discrete Instance

This setting defaults to Yes and applies to cue lists. When a fader is discrete, it will track other faders that are running the same cue list, BUT if a fader that it is tracking manually changes to a different cue list, a discrete enabled fader will not change its content. When set to No (or disabled), once a fader is in sync with another fader running the same cue list, it will stay in sync when content is changed. Discrete disabled is noted in the fader ribbon with a link icon.

## Size

A fader can be mapped so its content takes up 1, 2, or 3 faders. 1x will take up 1 fader, 2x will use 2 faders, and 3x will use three.



**Note:** If a fader is mapped to 1x, the top button will be locked as a load button. When mapped to 2x or 3x, the top left button will be locked as a load button.

## Buttons & Slider

When set to Default Mapping, the button and fader configuration is drawn initially from the cue list or submaster list properties for that content. If changes are made to that mapping in Tab 36, it filters BACK to the cue or submaster list and changes any other instances where that content is mapped. If set to Local, any changes made in Tab 36 impact only that instance of the content. See [Cue List Properties](#) and [Submaster Properties](#) for more information on default mapping.

## Target List

If temporary fader mapping is being used, the list of content will display here. See [Temporary Fader Mapping \(on page 247\)](#) for more information.

## Additional Configuration

Clicking on the configuration box will open additional configuration options that are dependent on the target type assigned to the fader.

For detailed information on these various options, please see the following topics:

- [Grandmaster Configuration \(on page 82\)](#)
- [Cue List Properties \(on page 278\)](#)
- [Submaster Properties \(on page 355\)](#)
- [Presets and Palettes Fader Properties \(on page 244\)](#)
- [Global Effects Fader \(on page 346\)](#)
- [Manual Time Master \(on page 83\)](#)

## Indicators in the Element Fader Status Display

Each fader is color coded based on its assigned target type. Channel faders are orange. Grandmasters and inhibitive submasters are in red, additive submasters are yellow, and presets, palettes, global effects, and manual time masters are brown.

The fader status display can be disabled in Setup. See [Displays \(on page 164\)](#) for more information.

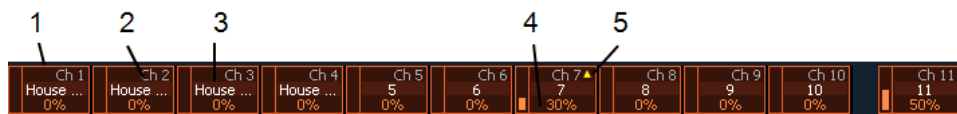

1. Orange box indicates a channel fader.
2. Current channel number controlled by fader.
3. Label (channel and target labels will display).
4. Current channel level. (Level will display regardless of control from fader or keypad.)
5. Up arrow indicates that there is a higher level currently set for the channel and that the fader needs to be raised to match.



1. Palette on a fader.
2. Current submaster number controlled by fader.
3. Red box indicates an inhibitive submaster.
4. Effect on a submaster.
5. Label (channel and target labels will display).
6. Grandmaster on a fader.
7. Up arrow indicates that there is a higher level currently set for the channel and that the fader needs to be raised to match.
8. Down arrow indicates that there is a lower level currently set for the channel and that the fader needs to be lowered to match.
9. Level of submaster currently.
10. [Global Effects Fader](#)
11. [Manual Time Master](#)

## Fader List

The Fader List, which shows all of the faders and their assignments, can be found in **Tab 35**.

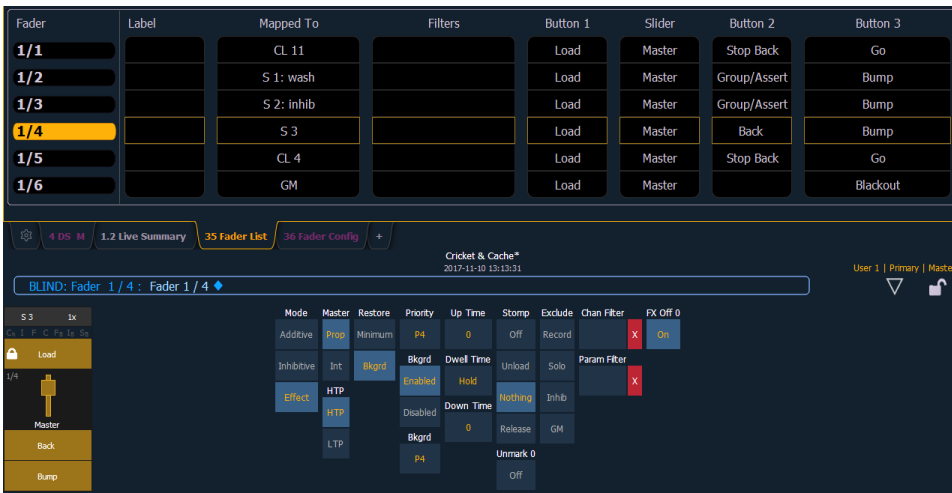

You can also make changes to a fader's configuration while in the fader list display by clicking on a column. A virtual fader will be displayed. Click on the appropriate area of the fader to access the configuration options. Selection can be done by clicking in the column or from the command line.

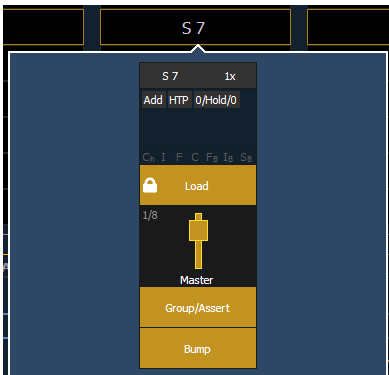

Range editing is possible in this display by selecting all the needed faders. Changes made to the configuration will be made to all of the selected faders.

With a fader selected, the CIA will also display a virtual fader and the configuration options for that fader.

## Fader Ribbon

The fader ribbon shows the fader color coding that is used in the fader configuration tools.

Grandmasters and inhibitive submasters are in red, additive submasters are yellow, playback faders display in green, and presets and palettes are orange.

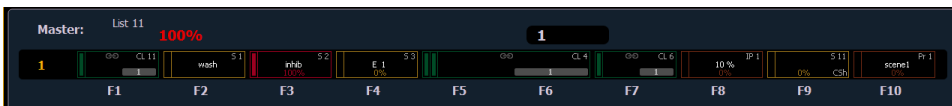

In the above screenshot, Fader 1 has discrete off. There is a link icon that displays to indicate that discrete is off.

## Master Fader Configuration

Click or tap Master Fader to open the master fader configuration window.



### Target

This setting allows you to map a cue list to a fader.

### ID

This sets the number of the target assigned to the fader, such as cue list 2. For a list of available Target IDs, click or press the {...} button beside ID.

Element 2 can only map to cue list 1.

### Discrete Instance

This setting default to Yes and applies to cue lists. When a fader is discrete, it will track other faders that are running the same cue list, BUT if a fader that is tracking manually changes to a different cue list, a discrete enabled fader will not change its content. When set to No (or disabled), once a fader is in sync with another fader running the same cue list, it will stay in sync when content is changed. Discrete disabled is noted in the fader ribbon with a link icon.

### Size

Master fader is set to a size of 2 faders and cannot be changed.

### Buttons & Slider

You can select to use default mapping for the fader, or you can use local mapping.



**Note:** When a user first joins a session, the master fader is unmapped. Once a cue list is established for that user, any other devices joining the user group will have the same cue list automatically mapped to their master. If a device changes its user ID, the cue list on the master will be remapped accordingly.

---

Additional configuration options are available. Please see [Cue List Properties \(on page 278\)](#) for more information.

## Grandmaster Configuration

When a fader is configured as a grandmaster, you can set the fader itself as a master or disable it. Fader size is set to 1x, and can not be changed.

The first button is locked as a load button, and cannot be configured. The second button is disabled and cannot be configured. The third button can be configured as a blackout button or disabled. When configured as a blackout, both buttons must be pressed to set the grandmaster to blackout.

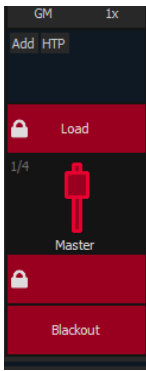

## Manual Time Master

A fader can be mapped as a manual time master.



**Note:** *Manual Time Master applies to changes made manually, not to playback.*

A manual time master can be used to impact any manual control timing. For a manual time master, you need to assign a minimum and maximum time settings to the fader. By default, the minimum is set to 0 seconds when the fader is completely down, and maximum is 5 seconds when the fader is at full. To change the timing, click on the box and enter the time from the popup number pad.



The fader buttons can be assigned as bump, disabled, or macro (see [Submaster Fader and Button Configuration \(on page 359\)](#)). It is recommended that the bottom button be set to bump for turning the fader on/ off. When turned on, the LED will be solid green.



**Note:** *The setting of the manual time master is ignore unless turned on. Changing the manual timing master will not impact any manual changes already in motion.*

The fader ribbon will display the label of M Time to indicate a manual time master fader.



**Note:** *Channel and parameter filters can be assigned to a manual time master.*

You can override a manual time master by using a command line entered sneak time.

## Master Only

Master Only is a fader option that can be assigned in the fader configuration display (Tab 36) or in the fader list (Tab 35) for submasters, presets, and palette faders. Submasters can also be configured in the Submaster List (Tab 15).

Master Only faders are used to set a level for content to fade to. The slider can be used to live adjust levels when the fader has been activated via the bump button.

Master Only faders default to Full.

To set the fader level from the command line, use **[Fader] [n] [At] [level] [Enter]**.



**Note:** *If content is set to proportional, Master Only fades all content to the setting of the fader when bumped. If set to I-Master, the fader masters the intensity, but non-intensity goes to the end state in time when the content is triggered.*

---

## Channel and Parameter Filters on Faders

Channel and Parameter Filters can be used to allow only specified data to be played back. These are playback filters, and do not impact how data is recorded.

Channel and Parameter Filters can be associated with the following targets for playback:

- Cue lists
- Submasters
- Presets
- Palettes



**Note:** *Channel and Parameters filters can also be used with Global Effects Faders. See [Global Effects Fader \(on page 346\)](#)*

---



**Note:** *For presets and palettes, channel and parameter filters can only be assigned in the fader configuration display (Tab 36) or in the fader list (Tab 35).*

---

For cue lists and submasters, channel and parameter filters can be set in the following areas:

- Cue List Index
- Submaster List
- Fader configuration display (Tab 36)
- Fader list (Tab 35)
- In Live using the **{Properties}** softkey

Tap or click on **{Chan Filter}** to assign channels or groups. Tap or click on **{Param Filter}** to open a list of available parameters that you can filter.



**Note:** *Filters will travel with their assigned cue lists and submasters wherever they are mapped.*

---

When a filter has been applied, an indicator will display in the fader ribbon. C will display for channel filter, and F is for parameter filter.



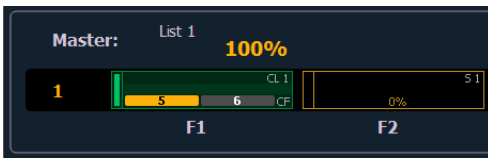

## Clearing Channel and Parameter Filters

Press the red [X] to clear the channel or parameter filters listed.



## Virtual Fader Module

A virtual fader module can be opened from the home screen by selecting the Faders button or by pressing [Tab] [2][8].

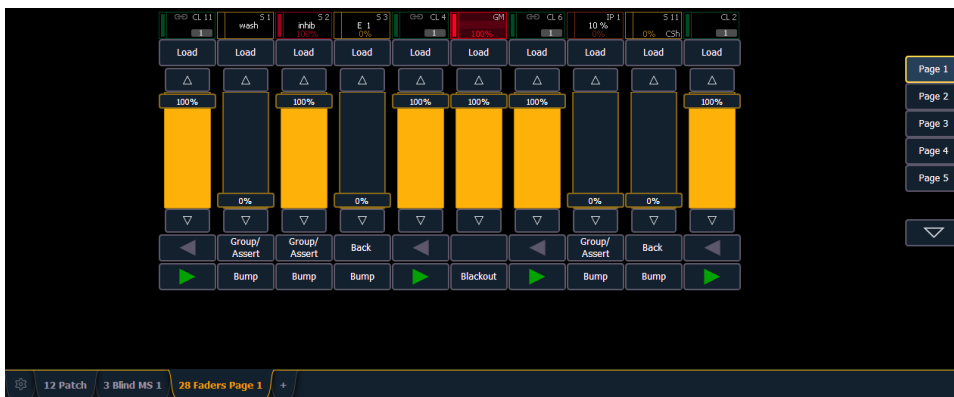

The virtual fader module has a configuration menu, which is accessed by first selecting the module tab and then double clicking on the tab to open the menu. With the virtual fader module selected, you can also select the gear icon, which is located by the tabs, to open the configuration menu.

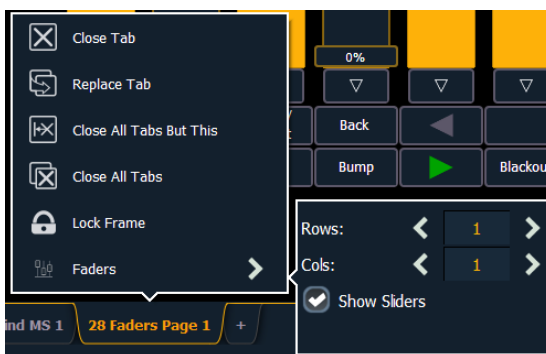

The following options are available in this configuration menu:

- **Rows** - sets the number of rows used for the module. Maximum number of rows is six.
- **Columns** - sets the number of columns used for the module. Maximum number of columns is six.
- **Show Sliders** - shows or hides the slider portion of the fader. This is useful if you want a module of just the configurable fader buttons.

For information about configuring your faders, see [Fader Configuration \(on page 78\)](#)

## Copying Faders Using Attributes Only

When copying faders, you can use **{Attrs Only}** to copy over all of the fader properties except levels, effects, and labels.

- **[Fader] [1] [Copy To] [Fader] [4] {Attrs Only} [Enter] [Enter]** - copies all of the fader properties from fader 1 and places it in fader 4. Levels, effects, and labels are not copied when using the **{Attrs Only}** softkey.

## Virtual Keyboard

It is possible to open a keyboard which mimics the hard keys found on the actual Eos keypad.

To open, you can select the virtual keyboard from the [Workspace Layout Menu \(on page 42\)](#) or use **[Tab] [7]**.

The virtual keyboard displays the alphanumeric keyboard shortcut for that hardkey in the lower right hard corner.



The abbreviations are:

- **Ca** - CTRL + ALT
- **S** - SHIFT
- **C** - CTRL
- **A** - ALT

## sACN Output Viewer

You can open the sACN Output Viewer by pressing **[Tab] & [3][7]** or selecting the sACN Output Viewer icon from the home screen.

The sACN Output Viewer is a place to check the current live outputs on a universe by universe basis.



The left side of the viewer is the universe grid. It displays 512 address cells. Cells outlined in a color are currently patched addresses. Each patched cell contains an address number and output value. Unpatched cells are black and only have an address level.

Output values are 0 through 255. 0 is displayed in black and 255 is in bright red. The red output value color will grow brighter as the output value increases.

If there is a channel or address selection on the command line, the appropriate address cell will be outlined in gold. You can also press on a cell to select it but it will not post to the command line. Information about the selected address will display to the right of the grid.

Any available sACN sources will be displayed in the right panel, and are color coded. The address cells will use that same color coding to indicate the device it is patched to.

Press **{About}** to open the About Address display in the CIA.

Press the **{<}** or **{>}** buttons to scroll through the available universes.

## Configuration Menu

The output viewer has a configuration menu, which is accessed by first selecting the viewer tab and then double clicking on the tab to open the menu. With the output viewer selected, you can also select the gear icon, which is located by the tabs, to open the configuration menu.

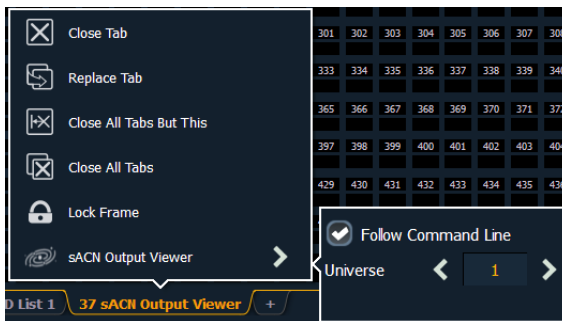

The following options are available in this configuration menu:

- **{Follow Command Line}** - when enabled, the viewer will follow the command line for selecting addresses. This is enabled by default.
- **Universe** - you can select which universe to jump the viewer to.



# Chapter 3

## Managing Show Files

---

About Managing Show Files .....	90
Create a New Show File .....	90
Open an Existing Show File .....	90
Merging Show Files .....	93
Printing a Show File .....	95
Saving the Current Show File .....	97
Importing Show Files .....	99
Exporting a Show File .....	101
Exporting Logs .....	101
Deleting a File .....	102
File Manager .....	102

## About Managing Show Files

This section explains how to create, open, and save your show files. Each of these operations are accomplished through the [Browser \(on page 33\)](#) area in the [The Central Information Area \(CIA\) \(on page 30\)](#).

### Create a New Show File

To create a new show file, navigate within the browser to: **File> New>** and press **[Select]**.

You will be prompted for confirmation that you want to create a new show. **Any unsaved show data will be lost.** Press **{OK}** to confirm or **{Cancel}** to discontinue the operation.

### Open an Existing Show File

Names of show files may appear in the browser list in normal text or in **bold text**. Files in normal text indicate that there is only one show file stored by that name.

**Bold** show names indicate that there are several versions of the show file stored under that name, the bold one being the most recent. To access the most recent show file, simply select the bold name. You may right arrow **[Page ►]** from the bold name to expand a list of previous versions beneath it in the browser. Select the desired show from the expanded list.

To open an existing Eos Family show file, navigate within the browser to: **File> Open>** and press **[Select]**.



Eos provides you with multiple locations to retrieve an Eos Family show file (.esf) including:

- **Show File Archive** - This is the default storage location for show files when a show file is created and saved. Older versions of the show file will be listed under the most current version. This allows you the ability to open the latest version or an earlier version of a show file if desired.
- **Network Drive**- if one is connected. When there is no network drive connected, it will not display in the Browser.
- **USB device** - When a USB device is connected and an Eos Family show file (.esf) is available on the device, you will notice the USB is displayed in white text and is expandable.

Open the desired location:

- To open a show file from the Show File Archive, navigate within the Browser to: **File> Open> Show File Archive** and press **[Select]**.
- To open a show file from the network drive, navigate within the Browser to: **File > Open> Name of Network Drive>** and press **[Select]**.
- To open a show file from a USB device, navigate within the Browser to: **File> Open> Name of Drive** and press **[Select]**.

Select the specific show file

- Navigate within the specified storage location and select the show file you wish to open, press **[Select]**.

- If the selected show has multiple time stamps and you wish to load an older version, navigate to the desired revision and press **[Select]**.

This will open the partial show loading screen in the CIA.



From this screen you can select which components of the show file you wish to load. The buttons at the center of the CIA represent all of the show components that you can choose to load. By default all components are selected (gray) and will be loaded. To withhold any show components from loading, simply deselect them in the CIA by touching the respective button.

To reselect all show components, press the **{Reset}** button and all buttons will return to gray (selected). To stop the show load process, press the **{Cancel}** button.

When you have selected/deselected all of the show components you require, press the **{OK}** button.

Eos loads the selected show to the console.



**CAUTION:** *On a partial show open, if any record targets are not opened, any existing data of that type will be cleared from the console. To merge show data, merge should be used. See [Merging Show Files \(on page 93\)](#)*

## Selective Partial Show Opening

If you select the **{Advanced}** button in the partial show opening screen, you will have the opportunity to load partial components from the show file and be able to specify the desired location of those partial components in the new show file.

For example, you could specify only cues 5-10 from cue list 2 and load them as cues 20-25 in cue list 7 in the new show. You could also specify only specific palettes, presets, effects, and so on. To see the complete list of show components, press the **{Advanced}** key in the partial show loading screen.

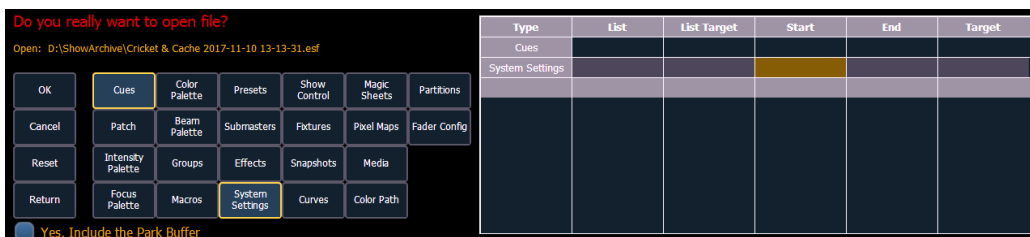

As you specify components, they are added to a table in the CIA. In the table, fields with a dark background may be edited, fields with a light gray background do not apply to that component. For each component in the list, you can specify the desired range by pressing the proper area in the table and entering numbers from the keypad. The columns in the table are:

- List - The list you are taking data from (such as a cue list).
- List Target - The list you are adding the data to.
- Start - The first in a range of components (such as a range of cues).
- End - The last in a range of components.
- Target - The desired location of the components in the new show file (for ranges, this will be the location in the new show of the first component in the range, the others will follow in order).



**Note:** In the **{Advanced}** view, you can use the **[Thru]** key to jump to the End column and **[At]** to jump to the Target column.

---

To open only partial components from a show file:

1. From the browser, navigate to the desired show file. See [Open an Existing Show File \(on page 90\)](#).
2. When the partial show load screen appears, press the **{Advanced}** button. The partial components selection screen will appear in the CIA.
3. Select the show components that you wish to load by pressing on their respective buttons on the left side of the CIA. The components will appear in the list to the right as you select them.
4. Press any fields for which you want to enter specific numbers. The field (if editable) will highlight in gold.
5. Enter the numbers using the keypad to specify the desired cues/groups/effects and so on.
6. Press **{OK}** to load the components to the new show.

You may exit the partial show load screen at any time by pressing the **{Cancel}** button. This will return you to the browser.

You may clear all selected components from the table at any time by pressing the **{Reset}** button.

You may exit the advanced loading screen at any time by pressing the **{Return}** button. This will return you to the general partial show load screen.

---



**Note:** Media is imported gobo and magic sheet images, and will be included by default when you select Patch, Fixtures, or Magic Sheets.

---

## Partial Patch Opening

You have the option to selectively open partial patch information or fixtures into a show file by selecting the **{Advanced}** button in the partial show opening screen. Select **{Patch}** or **{Fixtures}**.

---



**Note:** It is important to remember that on a partial patch open, if any record targets are not opened, any existing data of that type will be cleared from the console. To keep that data, merge should be used.

---

You can specify the desired range by selecting the proper area in the table and entering numbers from the keypad. The columns in the table that relate to patch are:

- Start - The first in a range of components.
- End - The last in a range of components.
- Target - The desired location of the components in the new show file (for ranges, this will be the location in the new show of the first component in the range, the others will follow in order).



## Show File Advisory

If the loaded show file exceeds the console's output capacity, an advisory will display in the CIA. You will need to dismiss the advisory by pressing **{Ok}** before continuing. To see the capacity of the console, press **[About]**.

## Park Buffer

The contents of the Park buffer are saved with show files. By default, the park buffer will not open with a show file.

You can load the park buffer, but it requires an additional step of confirming that you want to open the park buffer. You will need to click or press the check box by the text **Yes, Include the Park Buffer**.



For more information about park, see [About Park \(on page 350\)](#)

## Merging Show Files

Eos supports the merging of .esf (Eos Family) show files.



**Note:** Merging show files is different from opening show files. When you do a partial open of show components, untouched record targets are cleared. When you do a merge, those record targets remain.

You have the option of merging .esf show files from the Show File Archive, a File Server (if connected), or a USB device.

To merge a show file, navigate within the Browser to: **File> Merge>**. Navigate to the desired storage location and press **[Select]**. When using merge, Eos displays only the available files. Navigate to the specific file and press **[Select]**.

This will open the merge screen in the CIA. From this screen you can choose which aspects of the show file you want to merge. By default all aspects are unselected (black). Selected show aspects will appear in gray.



**Note:** Media is imported gobo and magic sheet images, and will be included by default when you select Patch, Fixtures, or Magic Sheets.

If you select the **{Advanced}** button in the merge show loading screen, you will have the opportunity to load partial components from the show file and be able to specify the desired location of those partial components in the current show file.

For example, you could specify only cues 5-10 from cue list 8 and load them as cues 20-25 in cue list 7 in the current show. You could also specify only specific palettes, presets, effects, and so on. To see the complete list of show components, press the **{Advanced}** key in the merge show loading screen.

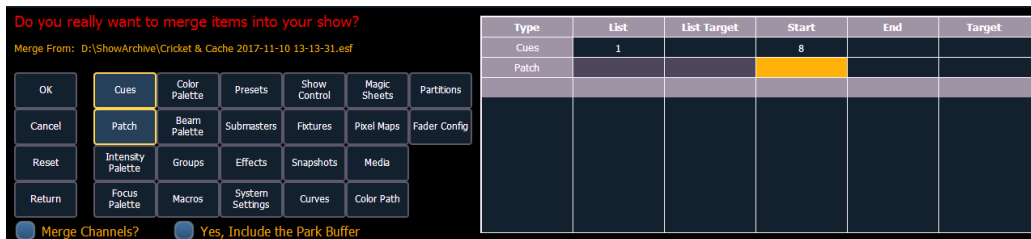

As you specify components, they are added to a table in the CIA. In the table, fields with a dark background may be edited, fields with a light gray background do not apply to that component. For each component in the list, you can specify the desired range by pressing the proper area in the table and entering numbers from the keypad. The columns in the table are:

- List - The list you are taking data from (such as a cue list).
- List Target - The list you are adding the data to.
- Start - The first in a range of components (such as a range of cues).
- End - The last in a range of components.
- Target - The desired location of the components in the new show file (for ranges, this will be the location in the new show of the first component in the range, the others will follow in order).



**Note:** In the **{Advanced}** view, you can use the **[Thru]** key to jump to the End column and **[At]** to jump to the Target column.

To merge channels, see [Partial Show File Channel Merge \(on the facing page\)](#)

To merge only partial components:

1. From the browser, navigate to the desired show file (see [Open an Existing Show File \(on page 90\)](#)).
2. When the merge show load screen appears, press the **{Advanced}** button. The partial components selection screen will appear in the CIA.
3. Select the show components that you wish to merge by pressing on their respective buttons on the left side of the CIA. The components will appear in the list to the right as you select them.
4. Press any fields for which you want to enter specific numbers. The field (if editable) will highlight in gold.
5. Enter the numbers using the keypad to specify the desired cues/groups/effects and so on.
6. Press **{OK}** to load the components to the current show

## Partial Patch Merging

You have the option to selectively merge partial patch information or fixtures into a show file by selecting the **{Advanced}** button in the partial show merge screen. Select **{Patch}** or **{Fixtures}**.

You can specify the desired range by selecting the proper area in the table and entering numbers from the keypad. The columns in the table that relate to patch are:

- Start - The first in a range of components.
- End - The last in a range of components.

- Target - The desired location of the components in the new show file (for ranges, this will be the location in the new show of the first component in the range, the others will follow in order).

## Partial Show File Channel Merge

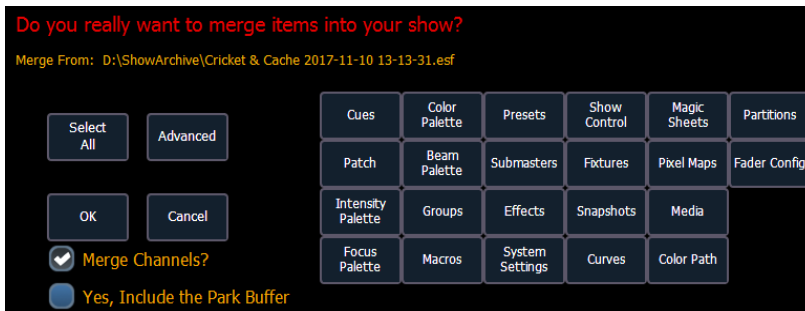

When Merge Channels is selected, channels from cues, submasters, groups, and other channel targets will be added to any existing channel targets of that same type.

With Merge Channels not selected, those channels will override any existing channels in the channel targets of the same type.

### Example:

In a show file 1, group 1 has channels 1 through 5. In show file 2, group 1 had channels 6 through 10. With Merge Channels and Groups selected for the merge, show file 2's group 1 will merge with show file 1's group 1. Group 1 will then have channels 1 through 10. If Merge Channels was not selected, group 1 would just have channels 6 through 10.



**Note:** It is important to remember that if the same channels exist in both show files, the data merging in will override the existing data for those channels.

## Printing a Show File

Eos provides you with the ability to save a show file or aspects from a show file to a PDF file for printing. Eos has three locations to save the PDF files including the Show File Archive, the File Server (if connected), or a USB device (if connected). Saving the PDF file to a USB (F:) device, allows you to then print the PDF from a personal computer. Printing directly from Eos is not supported.

In Setup, you can select the page orientation and paper size for these PDF files, see [PDF Settings \(on page 166\)](#) for more information.

To save a PDF of an Eos Family show file, navigate within the browser to: **File> Print>** and press **[Select]**.

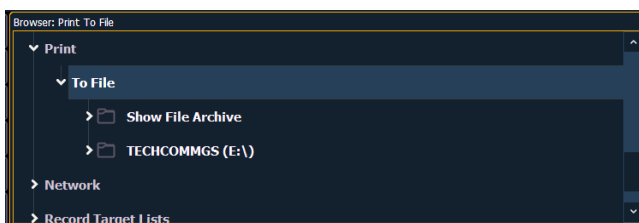

This will open the printing screen in the CIA. From this screen you can choose which aspects of the show file you want to save to PDF. By default all aspects are selected (gray) and will be saved. To withhold any show aspects from printing, simply deselect them in the CIA by touching the respective button. Deselected show aspects will appear in black.

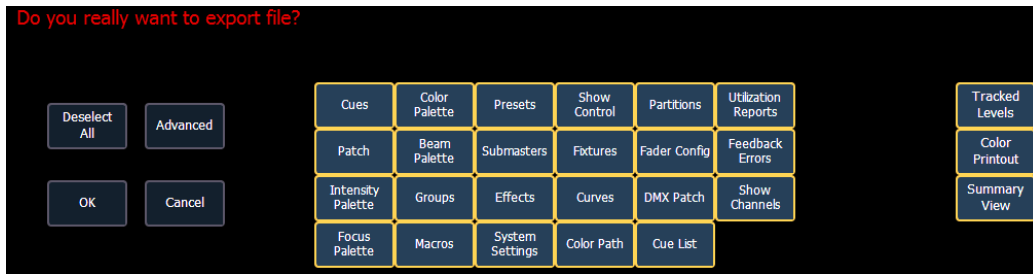

To reselect all show aspects, press the **{Select All}** button and all buttons will return to gray (selected). To stop the show file from being saved to a PDF and return to the browser, press the **{Cancel}** button. When you have selected/deselected all of the show aspects you require, press the **{Ok}** button to create the PDF file.

There are three additional options on the far right side of this display:

- **Tracked Levels** - prints all of the moves and tracked values.
- **Color Printout** - prints the cue data using the same color indicators as the console's displays use. See [Color Indicators \(on page 55\)](#)
- **Summary View** - prints cues without non-intensity parameter information.

You can also choose to print specific portions of show aspects. To select this information, press the **{Advanced}** button. The buttons at the center of the CIA will again represent all of the show aspects that you can choose. By default all aspects will be deselected (black).

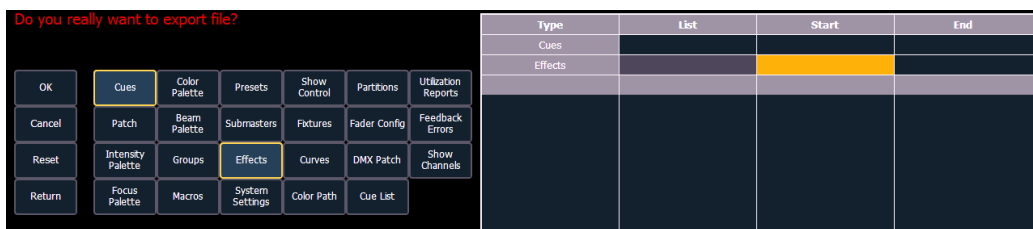

As you select aspects, they will be added to the table in the CIA. For each component in the list, you can specify the desired range by pressing the proper area in the table and entering numbers from the keypad. The columns in the table are:

- **List** - The list you are taking data from (such as a cue list).
- **Start** - The first in a range of components (such as a range of cues).
- **End** - The last in a range of components.



**Note:** In the **{Advanced}** view, you can use the **[Thru]** key to jump to the End column.

To deselect all show aspects, press the **{Reset}** button and all buttons will return to black (deselected).

To return to the main print screen, press the **{Return}** button. To stop the show file from being saved to a PDF file and return to the browser, press the **{Cancel}** button. If you are ready to save the file, press the **{Ok}** button. You will be prompted to name the file.

The PDF will have the show name, date and time it was created, and date and times for when the show file was last saved. It also gives the Eos Family software version information. If multiple aspects were selected to save to the file, there will be hyperlinks at the top of the PDF so you can quickly jump to a section.



**Note:** *If you have cues selected, cue notes and scenes will display along with additional cue information.*

## Saving the Current Show File

To save the current show data, navigate within the browser to: **File>Save>** and press **[Select]**. A green "Success" message should appear when the file has finished saving. If a red "Failed" error appears, attempt to save to a different location, or exit and/or restart Eos as soon as possible.

The Show File Archive is the default storage location for show files when they are saved. The new time stamp located beneath the show file name on the CIA indicates that the show file has been saved.

All previous saves are stored in the Show File Archive with the time stamp following the file name.

## Show File Indicator

An asterisk (\*) will display beside the show file name to indicate when a show file has been modified but not saved.

A dark blue rectangular button with the text "Cricket &amp; Cache\*" in white. The asterisk is positioned to the right of the text.

## Save Show File Warning

If there is unsaved data in the current show file, a save warning will display when you attempt to open a new or existing show file.

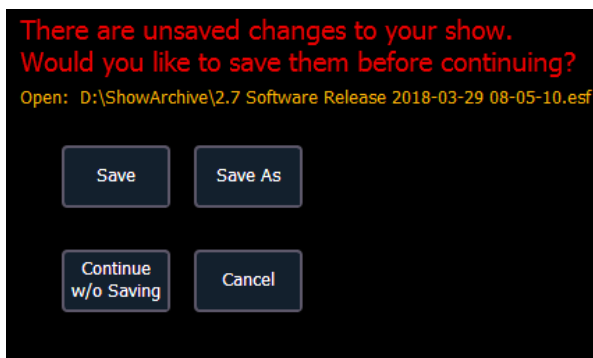

The following options will be available:

- **Save** - saves the current show file, and opens a new or existing show file.
- **Save as** - saves the current show file to a different location or with a different name, and opens a new or existing show file.
- **Continue without Saving** - opens the new or existing show file without saving any changes to the current show file. Changes will be lost.
- **Cancel** - returns to the current show file without saving changes or opening a different file.

## Save Errors

To save the current show data to the internal drive without having to navigate to the browser, hold down **[Shift] & [Update]**.

## Using Save As

To save an existing Eos Family show file to a different location or with a different name, navigate within the Browser to: **File> Save As>** and press **[Select]**.

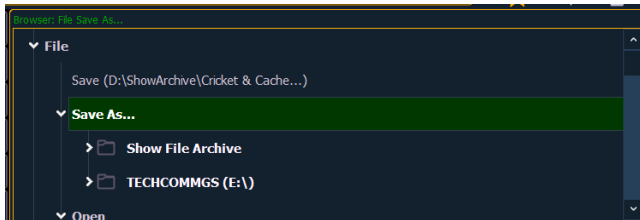

Eos provides you with three locations to save an Eos Family show file (.esf) including the Show File Archive, the File Server (if connected) or a USB device (if connected).

Navigate to the desired storage location and press **[Select]**. When using “Save As” to save the show file to a specific location, the alphanumeric keypad will display on the CIA. Name the show file and press **[Enter]**. The show file will be saved in the specified location with the show file name you entered with a time stamp suffix.

By default, the current show file name will be used. Pressing **[Label]** or **[Delete]** on the console, or DELETE on an alphanumeric keyboard will remove the default show label when doing a Save As.

## Saving with Extra Compression

The Save and Save As dialogs include a checkbox option labeled, “Use extra compression (.esf2) that prevents loading in versions prior to v2.9.0?”



Checking this box will compress your show file to an ESF2 file format, which will only be compatible with Eos versions 2.9.0 and higher. ESF will continue to be compatible with all versions of Eos software.

If you have already saved a show file with this option enabled, the box will default to checked when you use the Save or Save As functions.

If you wish to convert an ESF2 file back, uncheck the box in the Save or Save As dialog, and the show file will save as an ESF.

## Importing Show Files

Eos supports the import of standard USITT ASCII, .csv, and Lightwright® text files.



**Note:** Eos supports ASCII show file import from a number of other control consoles, including the Congo/Cobalt, Obsession, Expression and Emphasis product lines, as well as the Strand 500 Series. Please note that all show files must be saved in an ASCII format prior to importing them into Eos.



**CAUTION:** The way data is stored and used is often different between different desks. Imported data may not playback exactly the same between desks. Not all data (such as effects and macros) may be imported. This varies by product.

You have the option of importing standard USITT ASCII (.asc), .csv, or Lightwright (.txt or .asc) from the Show File Archive, a File Server (if connected), or a USB device.



**Note:** .asc file must be imported using the USITT ASCII option, even if it is a Lightwright file.

To import a show file, navigate within the Browser to: **File> Import> (Type of file to import)** and press **[Select]**.

If you are importing an USITT ASCII file, you will have two options, Import as Library Fixtures or Import As Custom Fixtures.

- Import as Library Fixtures will allow Eos to try to match the fixtures in the file with fixtures in the Eos library.
- Import as Custom Fixtures will bring the fixtures in as they are in the file.

It is recommended to use Import as Custom Fixtures.

Navigate to the desired storage location and press **[Select]**. When using import, Eos displays only the available files. Navigate to the specific file and press **[Select]**.



**Note:** Not all data is saved to a .csv file. It is recommended that you first export as a .csv file, modify the file as needed, and then import. See [Exporting a Show File \(on page 101\)](#) for more information.

Choose the aspects of the file you wish to import (all are selected by default). If "Merge Data" is not selected, the ASCII data will overwrite your current show data. If "Merge Data" is selected, the ASCII data will be merged into your current show.

## Lightwright Import

Once a file has been selected for import, you will now have options for importing.

Do you really want to import items into your show?  
Import From: E:\Music the Musical Level 2 Exported Data.bt

Reset Starting Channel  
OK Cancel Ending Channel Map Devices

Overwrite?  Import Text/Notes/Labels Only

Eos	Lightwright	Eos	Lightwright	Eos	Lightwright
Channel	Channel	Notes	<Ignore>	Text6	<Ignore>
Address	Dimmer	Text1	<Ignore>	Text7	<Ignore>
Type	Device Typr	Text2	<Ignore>	Text8	<Ignore>
Fixture Type	Instrument	Text3	<Ignore>	Text9	<Ignore>
Label	Purpose	Text4	<Ignore>	Text10	<Ignore>
Gel	Color	Text5	<Ignore>		



**Note:** *{Import Text/Notes/Labels/Gels Only}* allows you to import just the patch database text.

## Merge and Overwrite

You can select to either merge the data with the current show file, or to overwrite the data in the current file. To do this, check the **{Overwrite}** box. Leaving this box unchecked will merge the data.

## Starting and Ending Channel

You can select starting and ending channels for the import.

## Mapping

You can map Eos patch fields to fields in the Lightwright file. Channel and Address must be mapped for the file import to work. Any other field can be set to ignore if desired. Once a Lightwright field has been mapped, it will display in grey in the dropdown menu. However, greyed out options can be selected again for placement in multiple fields.

Eos	Lightwright	Eos	Lightwright	Eos	Lightwright
Channel	Channel	Notes	<Ignore>	Text6	<Ignore>
Address	Address	"When, What, and Who Changed"	<Ignore>		
Type	Device Type	Accessory			
Fixture Type	<Ignore>	Address			
Label	Purpose	Bot			
Gel	Color	Channel			
		Circuit Name			
		Circuit Name & Circuit#			
		Circuit#			
		Color			

The text fields in the Patch display and database will rename based off of the Lightwright imported fields. See [Renaming Text Fields in Patch \(on page 127\)](#) for more information.



**Note:** *Eos does not currently support multiple gels per fixture from Lightwright.*

## Address Formats

Eos will accept multiple address formats for importing. Examples of those formats are 2/3, 2.3, 2,3, 2-3. Eos will convert all formats to n/n.

## Device Mapping

Devices can also be mapped. Click **{Map Devices}** to open the following display.

Lightwright	Eos	Mapping	Link Devices	Unlink Devices
Device	<ul style="list-style-type: none"> <li>○ D60 DLght</li> <li>○ D60 Fire</li> <li>○ D60 Ice</li> <li>○ D60 Lustr+</li> <li>○ D60 Studio</li> <li>○ D60 Tungs</li> <li>○ D60 Vivid</li> <li>○ Lustr</li> <li>○ Paletta</li> <li>○ Pearl</li> <li>○ Revolution Original</li> </ul>	Other Color Kinetics ColorBlast 12 -> ColorBlast 12 Cyc Electric -> Cyc Flood Martin Mac 700 Profile -> Mac 700 Profile Ext Robe Robin 300 LED Wash M3 -> Robin 300... S4 10" -> Dimmer Source Four 19" -> Profile Source Four 26" -> Profile Source Four 36" -> Profile Source Four Par WFL -> Parcan VL2000 Wash -> VL2000 Wash Enhanced 16...		



Select the Lightwright device and the match from the Eos column. Multiple Lightwright devices can be selected at a time. Then click **{Link Devices}**. The link will appear in the Mapping column. To unlink a device, select it from the Mapping column, and then press **{Unlink Device}**.

Device mapping and import fields are saved with the show file.

## Importing Custom Gobo Images

Custom gobo images can be imported by going to **Browser> Import> Gobo Images** and selecting an image file or folder. If a folder is selected, all image files within the folder will be imported. All standard image files are supported with the exception of .svg files.

Imported gobo images can be deleted by going into **Browser> Import> Gobo Images> Imported Gobos**, selecting the image, and pressing **[Delete] [Enter]**.

## Exporting a Show File

Export your Eos Family show file to a standard USITT ASCII, .csv, Focus Track, Moving Light Assistant (MLA) or Fast Focus Pro show file using the export feature.

To export your Eos Family show file in ASCII format, navigate within the Browser to: **File> Export>** and press **[Select]**.

You have the option of exporting your show file in ASCII format to the Show File Archive, to a File Server (if connected) or to a USB device.

Navigate to the desired storage location and press **[Select]**. The alphanumeric keypad will display on the CIA. Name the show file and press **[Enter]**. The file will be saved in the specified location with the file name you entered with a ".asc" file extension.

You can export Eos Family show files as a .csv format by navigating within the browser to: **File> Export> CSV** and select the location for the export, the Show File Archive, a File Server (if connected), or to a USB device.

Files can be exported in a Focus Track or Fast Focus Pro format by going to **File> Export> Fast Focus Pro** or **Focus Track** and select the location for the export, the Show File Archive, a File Server (if connected), or to a USB device.

Files can be exported in a Moving Light Assistant (MLA) format by going to **File>Export>Moving Light Assistant**.

This will open the export screen in the CIA. From this screen, you can choose which aspects of the show file you want to export. By default all aspects are selected and will be exported. To withhold any show aspects from exporting, simply deselect them in the CIA by clicking on the respective button. Deselected show aspects will appear in black.

You can also choose to export specific portions of show aspects. To select this information, press the **{Advanced}** button. In the Advanced screen, all aspects are deselected (black) by default.

To stop the show file from being saved for export, press the **{Cancel}** button. If you are ready to save, press **{Ok}**. You will be prompted to name the file. A .csv file will be created.

## Exporting Logs

Logs are useful tools for diagnosing issues. ETC Technical Services may request that you email logs if they are assisting you with an issue. See [Help from ETC Technical Services \(on page 1\)](#) for information about contacting Technical Services.

If you are experiencing an issue, press **[Displays] & [Record]** to put a marker in the log file. This marker along with any other additional information you provide will assist us in reproducing your issue.



**Note:** Logs can also be created from the ECU. If created through the ECU, you will have the option to add additional information to the file. See [Save Logs \(on page 468\)](#) for more information.

Logs can be exported by going to the Logs option in the Browser. Select the location for the export, the Show File Archive, a File Server (if connected), or to a USB device, and press **[Select]**.

An exporting logs message will appear while the log files are being created.

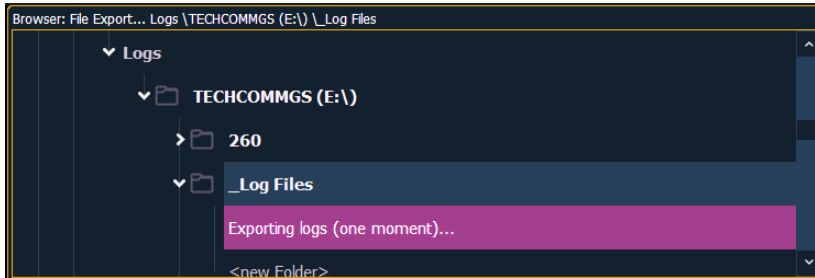

## Deleting a File

Eos provides you with the ability to delete show files from the Show File Archive and the File Server from within the Browser.

### To Delete a Show File

Navigate within the Browser to: **File> Open** and press **[Select]**. Navigate to the desired show file and press **[Delete]**. Press **[Enter]** to confirm or any other key to abort the deletion process.

### To Delete a Folder

The folder must first be empty.

Navigate within the Browser to: **File> Open** and press **[Select]**. Navigate to the desired folder and press **[Delete]**. Press **[Enter]** to confirm or any other key to abort the deletion process.

## File Manager

Eos has a [File Manager \(on page 469\)](#), which also provides a way to manage show files.

# Chapter 4

## Patch

---

About Patch .....	104
Patch Main Displays .....	105
Patching Conventional Fixtures .....	106
Patching Moving Lights, LEDs, and Accessories .....	112
Patching Multicell Fixtures .....	113
Labeling .....	116
Using the Scroller/Wheel Picker and Editor .....	116
Settings in Patch .....	122
Using Device List .....	127
Clearing the Patch .....	133
Update Profile .....	133
Fixture Editor .....	133

## About Patch

Eos treats fixtures and channels as one and the same, meaning each fixture is assigned a single control channel number. Individual parameters of that fixture, such as intensity, focus, color, and beam are also associated with that same channel number but as additional lines of channel information.

The Patch is used to associate a channel with addresses and device types. Once a channel is patched to an address or addresses, and the output is connected to a device (for example a dimmer, moving light, or accessory), the channel will then control that device.

Patching can be done via two different methods: manually entering a patch and by patching devices using RDM via the Device List. RDM allows bi-directional communication between the desk and any RDM devices over RDM or Ethernet. See [Using Device List \(on page 127\)](#).

For manual patching, you are required to only enter the simplest data to patch a device and begin programming your show, such as the channel number, the device type (if needed), and address. When you provide more information in the patch, you will have more detailed control and improved function during operation.

One or more devices may be patched to a single channel. For example, you may want to patch a group of dimmers to the same channel. In addition you may patch multiple devices to the same channel for building compound or accessorized fixtures. For example, a Source Four® with a color scroller and a gobo changer may be patched to a single channel. This is referred to as a compound channel. See [Creating multipart and compound channels \(on page 111\)](#).

When you open a new show file, Element 2 can create a 1-to-1 patch. This means that the patch will automatically have channel 1 patched to address 1, channel 2 to address 2, and so on up to the maximum channel count of your console. When outlined in yellow, the **{Patch 1 to 1}** button is selected, and a 1-to-1 patch will be created.

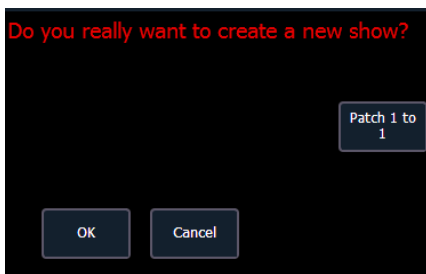
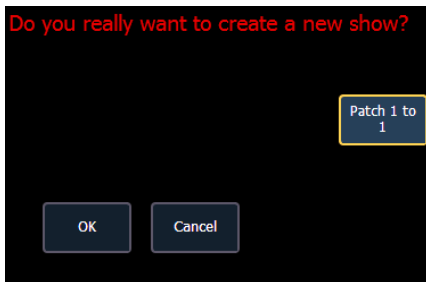

Depending on your situation, you may need to create a custom patch, which associates certain addresses with certain channels.



**Note:** You can open or merge patch data from other show files, see [Partial Patch Opening \(on page 92\)](#) and [Partial Patch Merging \(on page 94\)](#) for more information.

A 1-to-1 patch can be created from the Clear display. See [Clearing the Patch \(on page 133\)](#)

## Patch Main Displays

To begin patching your show, you must first open the patch display. To open the patch display, press **[Address/Patch]** twice or press **[Displays]** and then **{Patch}**. **[Tab] [1][2]** can also be used to open Patch.

The patch display will open in the selected tab, and the CIA will display patch controls.

From within the patch display, you can open the Device List to use RDM to patch any RDM compatible devices. For more information about Device List, see [Using Device List \(on page 127\)](#).

For patching fixtures, there are two different patch modes: [patch by channel](#) and [patch by address](#). Eos defaults to patch by channel mode. Pressing **[Format]** while in the Patch display will toggle the mode between patch by channel and patch by address.

Chan	Address	Type	Label	Interface					Output
				sACh	EDMX	DMX	AVAB	ARTN	
1		Dimmer		*		*			128
2	2	Dimmer		*		*			128
3	3	Dimmer		*		*			128
4	4	Dimmer		*		*			128
5									
6	P1 51	Dimmer		*		*			0
	P2 71	Coloram 2 Scroller		*		*			0
7	P1 52	Dimmer		*		*			0
	P2 72	Coloram 2 Scroller		*		*			0
8	P1 53	Dimmer		*		*			0
	P2 73	Coloram 2 Scroller		*		*			0
9	P1 54	Dimmer		*		*			0
	P2 74	Coloram 2 Scroller		*		*			0
10	P1 55	Dimmer		*		*			0
	P2 75	Coloram 2 Scroller		*		*			0

The patch screen will display the following information if available:

- **Channel** - the patched channel number. In patch by address mode, channel will appear blank if not currently patched.
- **Address** - the patched output address. In patch by channel mode, address will appear blank if not currently patched. Pressing **[Data]** toggles the display from showing address as patched by the user, output address, and the port/offset. See [Using Output Address vs Port/ Offset \(on page 107\)](#).
- **Type** - device or dimmer type that is patched.
- **Label** - displays the assigned label of the channel or address. See [Labeling \(on page 116\)](#).
- **Interface** - displays which interfaces will be used for the device. See **{Interface}** in [{Patch} Display and Settings \(on page 123\)](#).
- **Output** - displays the current live intensity level. Value is displayed as 0 through 255, with 255 being full. 16 bit intensity values will display as 0 through 65535.

## Status in the Patch Display

Status flags will display on the far left of the patch display to advise you when a channel or address requires your attention.

A red “!” or yellow “?” will display when there is an error or warning from an RDM, CEM+, CEM3, or ACN device. See [Errors and Warnings \(on page 132\)](#).

## Flexichannel Views in Patch

In patch by channel mode, **[Flexi]** can be used to view only those channels that are currently patched. In patch by address mode, **[Flexi]** can be used to view only those addresses that are currently patched. By pressing **[Flexi]**, you can toggle the view between patched channels/addresses, selected channels, and all channels/addresses.

Holding down **[Flexi]** will display the following softkeys:

- **{Flexi All}** - displays all the channels or addresses depending on which view is used.
- **{Patch}** - displays only the patched channels or addresses.
- **{Selected}** - displays any selected channels or addresses.
- **{View Channels}** - displays those channels selected for the View Channels flexichannel state.
- **{Partitioned}** - only available when partitioning is enabled. Displays the following options:
  - Partitioned Channels
  - Partitioned Patched Channels
  - Partitioned Selected Channels
  - Partitioned View Channels

## Patching Conventional Fixtures

For patching fixtures, there are two different patch modes: [Patching By Channel \(below\)](#) and [Patching By Address \(on the facing page\)](#). Eos defaults to patch by channel mode. Pressing **[Format]** while in the patch display will toggle the mode between patch by channel and patch by address.



**Note:** *When working with conventional devices, you can patch in either mode easily. When working with compound channels or multiple parameter devices, such as moving lights, it is recommended to work in patch by channel.*

---

## Patching By Channel

In patch by channel mode, **[2] [0] [At] [1] [Enter]** patches channel 20 to address 1. Pressing **[At]** will post address to the command line while patching by channel.

Chan	Address
1	1
2	2
3	3
4	4
5	
6	P1 51
	P2 71

Additional examples of patch by channel:

- **[5] [At] [1][0][0] [Enter]** - patches channel 5 to address 100.
- **[2][0][3] [At] [1][2] [Enter]** - patches channel 203 to address 12.

## Range Patching

Range patching using the [Thru] key allows you to quickly patch a group of channels. [1][Thru][2][0][At][1][0][Enter] patches channels 1 through 20 to addresses 10 through 29.

You can also use the [+] and [-] keys. [1][+][4][+][8][At][1][Enter] patches channel 1 to address 1, channel 4 to 2, and channel 8 to 3. The [Group] key can also be used if groups have been created.



**Note:** Range patching only works with channels. If you try to range patch addresses, parts for the channel will be created. See [Creating multipart and compound channels \(on page 111\)](#).

---



**Note:** If you try to patch a channel or address that exceeds the console's range, an error message will display on the command line.

---

## Patching By Address

Pressing [Format] while in the patch display will toggle the mode between patch by channel and patch by address.

Address	Chan
1	1
2	2
3	3
4	4
5	
6	
7	

[2][0][At][1][Enter] patches address 20 to channel 1. Pressing [At] will post channel to the command line while patching by address.

Additional examples of patch by address:

- [5][At][1][0][0][Enter] - patches address 5 to channel 100.
- [2][0][3][At][1][2][Enter] - patches address 203 to channel 12.



**Note:** If, at any point, you try to patch an address that is already in use, Eos will post an advisory to indicate this, preventing you from duplicating addresses in your patch.

---

## Using Output Address vs Port/ Offset

The output address is the DMX or network DMX (often called EDMX) address. Examples of output addresses are 510, 1, and 1024.

Port/ offset refers to the DMX universe or port and the offset of the address. For example, since a single DMX port can transmit 512 addresses (known as a "universe"), the port/ offset for address 515 would look like 2/3 because address 515 is the 3rd address of universe 2.

An example of patching by port/ offset in patch by address mode is [2][/][1][0][At][2][0][Enter], which patches universe 2 address 10, or 522, to channel 20.

[At][/][n][Enter] can be used to patch an address on the same universe that was last used.



**Note:** It is possible to patch by either address or port/ offset. Pressing the **[Data]** key will move between showing the patch as it was originally entered, then the output address values, and last the port/ offset.

---



**Note:** An address cannot be assigned to multiple channels, but a channel can have multiple addresses assigned to it.

---

## Replace

By default, if you patch an address to a channel that is already patched, Eos will create a new part for the new address. If you want to replace the current address with the new, use **{Replace}**:

- **[n] {Replace} [n] [Enter]** - replaces the address in part 1 of the selected channel.
- **[1] [Part] [3] {Replace} [5] [Enter]** - replaces the address of part 3 with a new address of 5.

## At Next

**[At] [Next] [Enter]** finds the next available address range large enough to accommodate the selected device.

Examples of **[At] [Next]**:

- **[At] [2] [/] [Next] [Enter]** - finds the next available address range on universe 2.
- **[At] [7] [7] [7] [Next] [Enter]** - finds the next available address after 777.

## [Address/Patch] [n] [/]

The syntax **[Address/Patch] [n] [/]** or **[At] [n] [/]** can be used to select a full universe in patch.

- **[channel list] [Address/Patch] [n] [/] [Enter]** or **[channel list] [At] [n] [/] [Enter]** - changes the addresses of all the selected channels to a new universe while using the same offset.
- **[Address/Patch] [2] [/] [Copy To] [Copy To] <Address> [3] [/] [Enter]** - moves all channels with addresses in universe 2 to the same offsets in universe 3.
- **[Address/Patch] [n] [/] {Unpatch}** - unpatches all patched addresses in the selected universe.

## Dimmer Doubling

You can patch channels in Eos to accommodate for dimmer doubling with Sensor dimmer racks. This is done using the softkeys available in patch (**{No Dim Db}**, **{A}**, and **{B}**).



### Example:

Let's assume you patch 96 channels of dimmers to addresses 1 through 96.

- [1] [Thru] [9] [6] [At] [1] [Enter]

Now you wish to dimmer double 1 through 12 of your Sensor+ rack and you want these to be channels 97 through 108. To patch this, press:

- [9] [7] [Thru] [1] [0] [8] [At] [1] {B} [Enter]

Channels 97 through 108 are patched to address 1 through 12 B, while channels 1 through 12 are now patched to address 1 through 12 A.

To remove the dimmer doubling from these addresses, you must first press [Format] to enter Address mode and then press:

- [1] [Thru] [1] [2] {NoDimDbl} [Enter]

Addresses 1 through 12 have been returned to single dimmer modes and channels 97 through 108 are now unpatched.

By default, doubled dimmers start with an offset network DMX address value of 20000. Therefore, in the above example, address 1B (channel 97) is actually controlled by network DMX address 20001. Address 2B is actually controlled by network DMX address 20002 and so on. This offset matches the default offset in CEM+ / CEM3 when configuring your Sensor dimmer rack for dimmer doubling. To change the default offset value, see [{Dim. Dbl. Offset} \(on page 151\)](#).



**Note:** For Sensor Classic racks using dimmer doubling, the offset value should be set to 256.



**Note:** Dimmer doubling needs to be turned on per DMX port in **Browser > Setup > System Settings > Output**. See [Outputs \(on page 157\)](#).



**Note:** There is also a Dimmer Doubling setting for Net3 Gateways with DMX outputs. This is used with Sensor racks that are connected via DMX. The Gateway must be properly configured.

## Moving and Copying Channels

Channels can be moved from one location to another within patch.

- [1] [Copy To] [Copy To] [2] - moves channel 1's data to channel 2. Channel 2's data is replaced by channel 1's. Channel 1 is unpatched.
- [1][Copy To] [Copy To] [2][Part][2] - creates a part 2 for channel 2 and moves channel 1's data to the new part. Channel 2's data remains in part 1. Channel 1 is unpatched.

The second press of the [Copy To] key changes the command from **Copy To** into **Move To**.



**Note:** *Move To* always impacts the entire show.

The following options are available with [Copy To]:

- [Copy To] - copies a channel to another location within patch.
- [Copy To] {Plus Show} - copies a channel to another location within patch and all record targets in the show.

- **[Copy To] {Only Show}** - copies a channel to another location with all record targets in the show but not the patch data.
- **[Copy To] {Only Text}** - copies only the notes and keyword fields from one channel to another.

## Swapping Channels

Channels can be swapped for each other in patch:

- **[1] {Swap} [2] [Enter]**

This syntax will replace channel 1's data with channel 2's and vice versa in patch and throughout the entire show.



**Note:** *Swap always impacts the entire show.*

---

The following options are available with **{Swap}**:

- **{Swap}** - swaps only the patched address
- **{Swap} {Plus Show}** - swaps all show and patch data
- **{Swap} {Only Show}** - swaps only the show data and not patch data
- **{Swap} {Plus Patch}** - swaps addresses and patch data but not show data

## Unpatch a Channel

To unpatch a channel while in patch you can press:

- **[n] {Unpatch} [Enter]**

The **{Unpatch}** softkey will reset all the properties of the channel to the default. This includes removing the device type if specified.

To retain all the elements of a channel except its address, you would instead use:

- **[n] [At] [0] [Enter]**

Using **[At] [0]** will allow unpatched channels to still be manipulated and have data stored for them, but they do not output any information (as they are unpatched).

## Deleting Channels

It is possible to delete channels in patch. Deleting channels is different from unpatching in that deleted channels cannot be manipulated or have data stored for them. When deleted, the channel numbers will still be visible in the live/blind display, but the channel graphic will be removed from the display.

### Example:

To delete channels in the patch display, press:

- **[6] [Thru] [1] [0] [Delete] [Enter] [Enter]**

-OR-

- **[Delete] [1] [Thru] [1] [0] [Enter] [Enter]**
- 



**CAUTION:** *If a channel with programmed data is deleted, the recorded data will be lost.*

---

## **[Query] {Unpatched}**

To quickly delete channels without addresses in the Patch display, you can use the command **[Query] {Unpatched} [Delete]**. This will post to the command line all channels without addresses. By pressing **[Enter][Enter]** you will delete them.

## **Using {Offset} in Patch**

Using the **{Offset}** feature in patch allows you to force a numerical offset between the starting address of channels in patch or for offsetting your channel selection. This feature is useful when you have configurable devices in your show, such as a Source Four Revolution, which has option slots for additional addresses (scrollers, indexing pattern wheels, and so on), or when your devices' start addresses use a known multiplier.

- **[1] [Thru] [2] [0] {Offset} [2] [At] [1] {Offset} [2] [0] [Enter]** - selects every other channel in the list and patches them with an offset of 20 addresses.

### **Example:**

When patching using a fixture type, this is a two step process because the command line terminates after a fixture type has been selected.

1. **[1] [Thru] [5] {Type} {Source Four Revolution}**
2. **[At] [1] {Offset} [3] [1] [Enter]**

Hitting **[At]** will reselect the previously selected channels. The channels can then be patched with an address offset of 31 channels, allowing you to have additional space within the patch for a given fixture type regardless of configuration or personality.



**Note:** For multiple parameter devices, Eos will automatically offset the addresses based on the fixture type.

## **Creating multipart and compound channels**

A multipart channel is any channel that has more than one dimmer patched to it. A compound channel has multiple profiles patched to it that make up one channel, an example would be a dimmer with a scroller and auto-yoke. By default, Eos will add a part if you are trying to patch to a channel that has already been assigned an address.

To patch a multipart channel in channel format:

- **[9] [At] [5] [4] [0] [Enter]**

Assuming that channel 9 is already patched to an address, this will create a part 2 and address it at 540.

- **[8] [Part] [2] [At] [5] [1] [3] [Enter]**

This will create a part 2 for channel 8 and address it at 513. If you wish to patch by address while in the channel view, press:

- **[Address] [5] [1] [3] [At] [8] [Enter]**

Assuming channel 8 was previously patched to an address, this will create a part 2 and address it at 513.

To patch a multipart channel in address format:

- **[5] [1] [3] [At] [8] [Enter]**

This will perform the same action as the previous example, assuming channel 8 was previously patched to an address.

To select multiple parts for editing:

- [1] [Part] [1] [Thru] [5]

This is useful for deleting or assigning new addresses to existing parts.

To patch a compound channel in channel format:

- [1] [Part] [2] [At] [5] {Type} <scroller profile>

Creates a part 2 for channel 1 and assigns it the selected scroller profile. See [{Patch} Display and Settings \(on page 123\)](#) for more information on using {Type}.

## Patching Moving Lights, LEDs, and Accessories

The process of patching moving lights requires more detail than patching a dimmer. Specific information is required for more advanced control of the features offered by moving lights.



**Note:** It is recommended that when patching moving lights, LEDs, and accessories that you work in patch by channel mode. See [Patching By Channel \(on page 106\)](#).

After you have entered the channel number, click {Type}. You will then select a device type from the fixture library.



Notice the four softkeys {Show}, {Manfctr}, {Search}, and {Add Show} located beneath the CIA.

{Show} provides you with the option of showing only the library of fixtures or devices that are already patched in the show, your favorites, and default devices. {Manfctr} shows all fixtures or devices available in the library sorted by manufacturer.

Press {Manfctr} from the CIA to display the fixture library. The two columns on the left are pageable and show manufacturer names. Use the arrow buttons to scroll the list of manufacturers. Selecting a manufacturer repaints the device columns with all devices from that manufacturer that are available for patching.

Scroll through the device list and make your selection. If a fixture has multiple modes or types, it will display in blue text. Clicking on its name will open a list of available modes. After the selection is made, the fixture or device type will be placed on the command line after the channel number and displayed in the box beneath the {Type} button.

Press {Search} to open the search window. You will need an external alphanumeric keyboard or you can click the keyboard icon in the search window to open the virtual keyboard. You can also navigate the list as you would the browser. You can search by manufacturer name, fixture name, part of a name, and by DMX footprint. For example, if you searched for 31, you would see all of the fixtures that have a DMX footprint of 31. Double clicking on a fixture name will patch it.

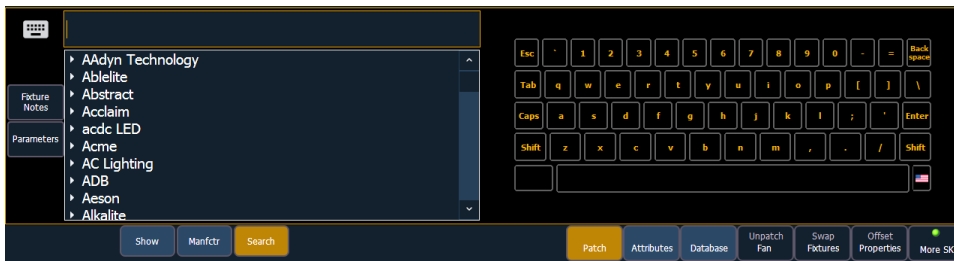

In the search window, press **{Parameters}** to view a parameter list for a fixture, or press **{Fixture Notes}** to see any notes that exist for it. You can also view this information in the Fixture Editor.

Press **[At]** and then enter a starting address for the selected channel or group of channels. The desk will automatically offset addresses based on the fixture type selected.

**{Add Show}** will add a fixture or device to your show list. If you want to delete a fixture or device from the show list, click **{Edit}** while in the show display. Select the device you wish to remove and click **{Delete}**.



**Note:** Fixtures can be added to your show list without first patching them. With nothing on the command line, click **{Type}**. You can then select a device type from the fixture library, and click **{Add Show}** to add to your show list.

To select a device interface (optional), click **{Interface}**. See [Output Protocols \(on page 463\)](#).

Click the **{Attributes}** softkey to set detailed moving light attributes. The following buttons may be available on this page depending on the device selected: **{Preheat}**, **{Proportion}**, **{Curve}**, **{Fan Curve}**, **{LD Flags}**, **{GM Exempt}**, **{Invert Pan}**, **{Invert Tilt}**, **{Swap P/T}**, **{Color Path}**, **{Scrollers}**, **{Gobo Wheels}**, **{Color Wheels}**, and **{Effect Wheels}**. Additional buttons maybe available based off of your fixture type. See [Attribute Display and Settings \(on page 124\)](#).

If your moving light includes parameters such as a color scroller or gobo wheel and you have custom gels or non-standard patterns installed, use the Scroller/ Wheel Picker and Editor to modify the device patched. The more specific your patch data (including accurate colors and patterns), the more detailed programming and operating will be. See [Using the Scroller/Wheel Picker and Editor \(on page 116\)](#).

## Patching Multicell Fixtures

Fixtures that have multiple same-type parameters can have a multicell profile assigned to them. The process for patching multicell fixtures is similar to patching moving lights. There are a few differences that are important to understand though.



**Note:** It is recommended that when patching multicell fixtures that you work in patch by channel mode. See [Patching By Channel \(on page 106\)](#).

After you have entered the channel number, click **{Type}**. You will then select a device type from the fixture library.

Fixtures that have multicell functionality will be listed with a MC in their mode description in the device list, and in the **{Show}** list.



**Note:** When using **{Search}**, the number of cells for a multicell fixture will also be displayed.

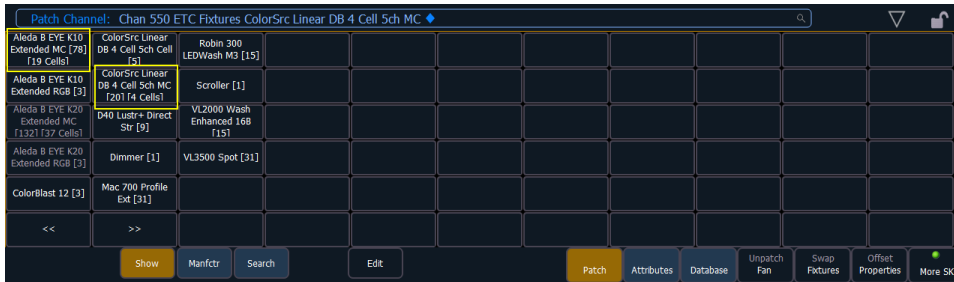

When these devices are patched, they will patch a master channel with a whole number for a channel number and the appropriate number of additional cells, which will have point numbers for their channel numbers.

- [1][0] [At] [5] [Enter] - patches channel 10 and all of its cells starting at address 5.
- [1][0] [.] [1][2] [Thru] [1] [At] [5] [Enter] - patches channel 10's cells 12 through 1 starting with cell 12's address beginning with address 5.

500		ColorSrc Linear DB 4 Cell 5ch MC	505	10/101-121	Aleda B EYE K10 Extended MC
. 1	10/1-5	ColorSrc Linear DB 4 Cell 5ch Cell	. 1	10/122-124	Aleda B EYE K10 Extended RGB
. 2	10/6-10	ColorSrc Linear DB 4 Cell 5ch Cell	. 2	10/125-127	Aleda B EYE K10 Extended RGB
. 3	10/11-15	ColorSrc Linear DB 4 Cell 5ch Cell	. 3	10/128-130	Aleda B EYE K10 Extended RGB
. 4	10/16-20	ColorSrc Linear DB 4 Cell 5ch Cell	. 4	10/131-133	Aleda B EYE K10 Extended RGB



**Note:** If the master channel has only a virtual intensity over the cells, an address will not be displayed, as that is a virtual parameter.

In the [fixture editor](#), you can view and edit the personality for your multicell fixture. For creating a new multicell fixture, see [Creating Multicell Fixtures \(on page 145\)](#).

On the left of the fixture editor, you can see the fixture name, overall DMX footprint and number of cells. Click on the caret to see the DMX footprint for the master and the cells. The cells will be grouped with their profile(s).

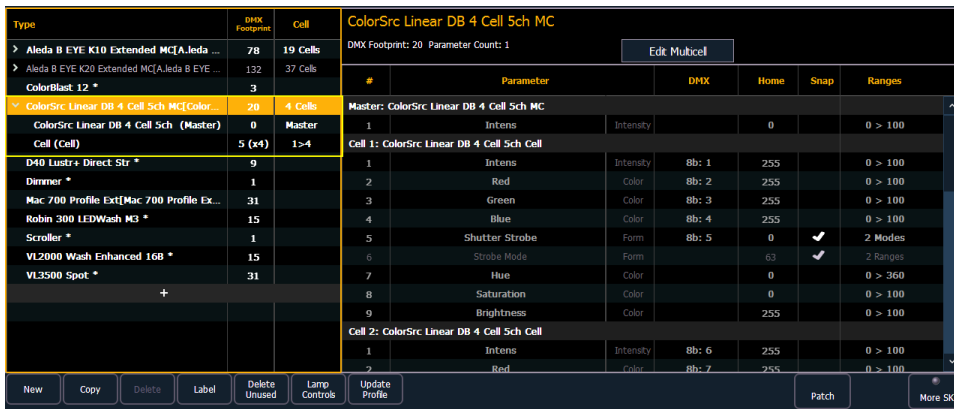

On the right, you can see the full personality of the selected multicell fixture. If you have the whole fixture selected, you will be able to see all of the parameters for each cell and the master but changes cannot be made here.

## Editing Multicell Fixtures

You will need to select the master or cell profile to edit parameters. In this view, you'll be able to edit parameters, DMX, Home, Snap, and ranges/modes. See [Creating a New Fixture \(on page 134\)](#) and [Range editing a parameter \(on page 137\)](#) for more information.

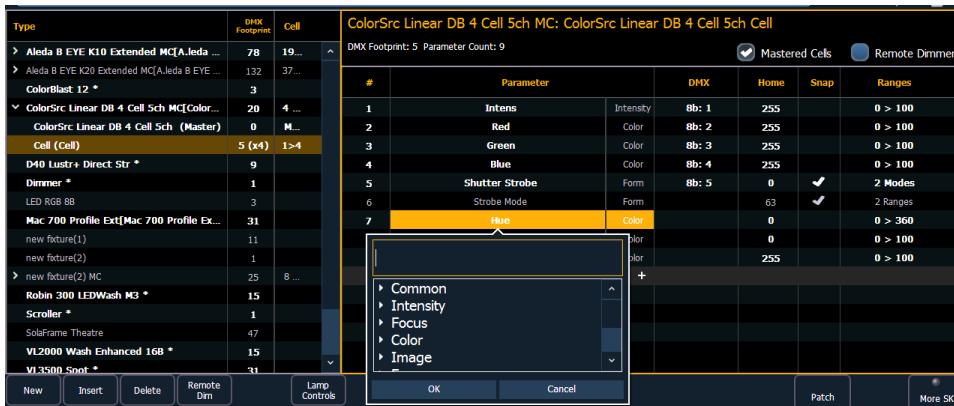

To change specific cell data such as DMX offset, you will need to use **{Edit Multicell}**. With a multicell fixture or a master cell selected in the fixture editor, press **{Edit Multicell}**. In the Edit Multicell window, you can edit cell numbers, DMX offset, and mastered cells for each cell.

Multicell Components	Cell	DMX Offset	DMX Used	Mastered Cells
ColorSrc Linear DB 4 Cell Sch MC	Master			
... Cell [5]	1>4	1,6,11,16	1>20	✓
... Cell [5]	1	1	1>5	✓
... Cell [5]	2	6	6>10	✓
... Cell [5]	3	11	11>15	✓
... Cell [5]	4	16	16>20	✓
	+			

Once you are finished editing, press **{Save Fixture}** to save your changes or **{Cancel Edit}** to remove the changes and exit the edit mode.

## Labeling

To label a channel or address, press the **[Label]** key with the channel or address selected on the command line. You can use the virtual alphanumeric keyboard or an external keyboard to enter the desired label text.



**Note:** If you would like your label to word wrap, use `//` to create a line break between words.

## Using the Scroller/Wheel Picker and Editor

The scroller and wheel picker allows you to choose a specific scroll, color wheel, gobo wheel, or effect wheel from standard manufacturers and associate them with fixtures. You may also create customized scrolls/wheels using the editor to match custom devices installed in your fixture.



**Note:** Scrollers, color wheels, gobo wheels, and effect wheels can be created without first selecting or patching a fixture.

## Using the Picker

Default color and pattern media for the selected fixture, as determined in the fixture library, is displayed in the **{Attributes}** page. Only the media attributes that are available for the selected fixture will display.

In the image below, the selected channel is a Source Four Revolution® with a color scroller and two gobo wheels. If the selected channel included other wheels, each device would be represented in the display with a button.





The picker displays on the left half of the CIA when you select the specific attribute (**{Scroller}**, **{Color Wheel}**, **{Gobo Wheel}**, or **{Effect Wheels}**). The picker displayed is specific to the selected attribute (the scroll picker will display when **{Scroller}** is pressed, the color wheel picker will display when **{Color Wheel}** is pressed, and so on).

The picker displays buttons for the standard scroll or wheel type of the selected channel. The default selection is the wheel as shipped from the manufacturer (derived from the fixture library). Displayed to the left of the standard scroll/wheel selection is a list of each color/gobo as they are installed in the selected device (frame by frame). When the color or pattern image is available, it will display next to the frame name.

In the above image, **{ETC Scroll}** is the default scroll for the selected ETC Source Four Revolution. The list of gel colors as they are installed in the scroll are displayed to the left with a color chip for easy reference. Selecting any other type, such as **{Martin Scroll 2}**, updates the frame list.

The softkeys displayed beneath the picker are **{Clear Calib}**, **{Copy Scroller}**, **{Clear}**, **{New}**, **{Copy}**, **{Edit}**, and **{Delete}**.

- **{Clear Calib}** - clears out the calibration data for the whole scroller wheel and returns to the wheel's default data.
- **{Copy Scroller}** - used to copy a scroller wheel and its calibration to another channel. See [Scroller Calibration Column \(on page 121\)](#).
- **{Clear}** - clears the selection type from the selected channel in the picker.
- **{New}** - creates a new scroll or wheel and provides additional softkeys to enable the Editor. See [Using the Editor \(below\)](#).
- **{Copy}** - makes a copy of the currently selected scroll/wheel type, which can then be edited using the editor. See [Using the Editor \(below\)](#).
- **{Edit}** - used to edit an existing scroll or wheel.
- **{Delete}** - used to remove the selected frame only from a scroll or wheel that you have created.

## Using the Editor

The editor is used to create new or edit copied scrolls and wheels. While in the picker display, you can create a new scroll or wheel by pressing the **{New}** softkey or make a copy of an existing scroll or wheel by selecting the source, then pressing the **{Copy}** softkey.

The editor does not limit how many frames you can add to the scroll or wheel for the selected fixtures. Keep in mind that any fixture has its own limitations. For example, if you have created a custom color scroll with 30 frames, your selected fixture type may only provide you access to the first 24 frames that you created. This applies to wheels as well.



**Note:** *If you try to select an existing scroll or wheel, the console will display a warning if it has more frames than are supported by your device.*

---

When using the editor, the following softkeys are available for use:

- **{Insert}** - inserts a new frame above the selected frame.
- **{Delete}** - removes the selected frame.
- **{Edit}** - changes the selected frame.
- **{Invert}** - reverses the order of the frames.
- **{Done}** - completes the editing process.

## Creating a new scroll or wheel

When you create a new scroll or wheel, **{New Wheel n}** appears in the wheel list as the selected button. The frame list will be empty with only “New” displayed in frame 1.

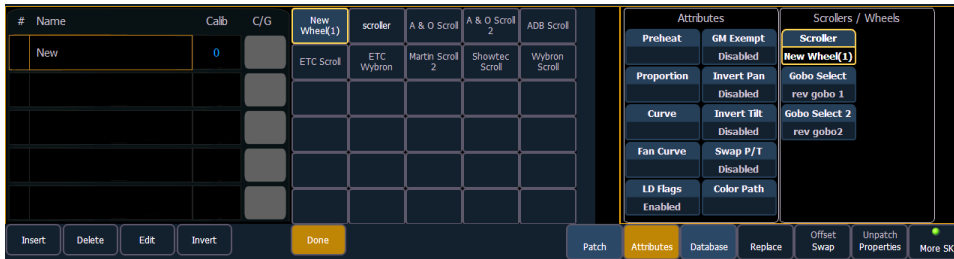

You can label the new wheel by pressing **[Label]** and typing the desired label on the virtual keyboard and pressing **{Enter}**.

To select a color or pattern for the specific frame in the scroll/wheel, select the “NEW” text and press **{Edit}** or click the gray box in the C/G column of the frame. The available gel, color, gobo and effect media selections will be displayed.

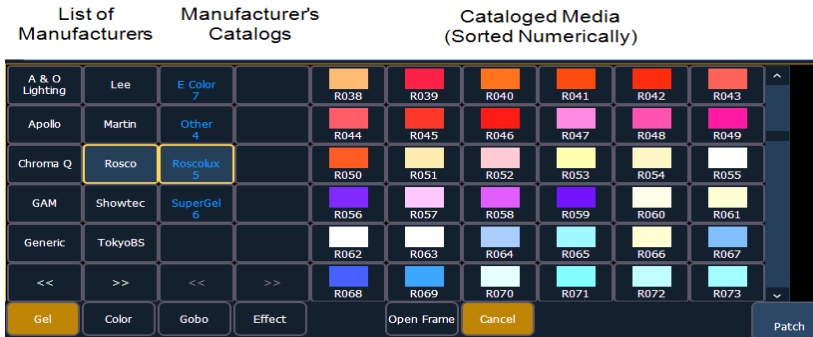

The media selection includes the following softkeys:

- **{Gel}**, **{Color}**, **{Gobo}**, and **{Effect}** - each will display available media selections as they are cataloged by the associated scroll or wheel manufacturers.
- **{Open Frame}** - places the frame in Open White. Generally, the first media frame is open.
- **{Cancel}** - cancels the media selection and returns to the frame editor.

When a manufacturer is selected from the list, the catalog selection changes to display only the selected manufacturer’s offerings. When a specific catalog is selected, the selected media will display.

When you make a media selection, the display returns to the new wheel frame list where additional frames can be added to the scroll or wheel by selecting the next frame area to add more frames.



**Note:** An **{Invert}** softkey will display when creating or copying a wheel or scroller. **{Invert}** is used to reverse the order of frames.



**Note:** It is possible to import custom gobo images. See [Importing Custom Gobo Images \(on page 101\)](#) for more information. To use a custom gobo image, select **{Gobo}** and then **{Custom}**.

## Editing a copy of a scroll or wheel

If a copy has been made of an existing scroll or wheel, the copied scroll or wheel will display as **{New Wheel n}** before the standard manufacturer offerings. The frame list will include an exact duplicate of the copied selection.

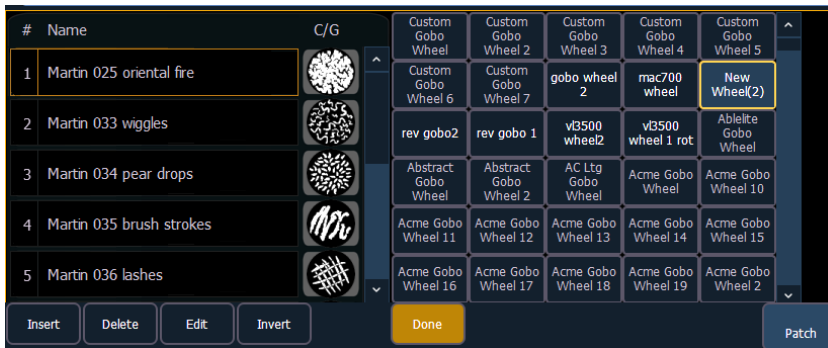

To make a change to a frame, first select the frame then press **{Edit}** or click the gray box in the C/G column to display the media selection. Or you can insert a new frame above a selected frame using the **{Insert}** softkey.

For example, to insert a new frame in between existing frames 2 and 3, select frame 3 and press the **{Insert}** key. The media selection will display.

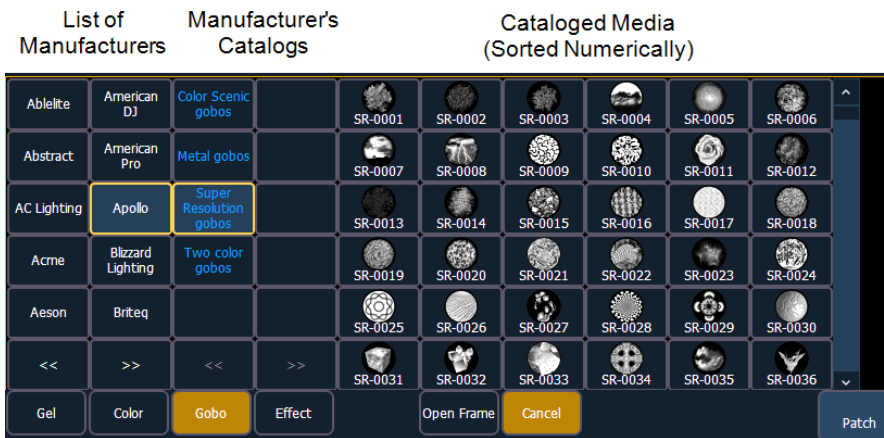

The media selection includes the following softkeys:

- **{Gel}**, **{Color}**, **{Gobo}**, and **{Effect}** - each will display available media selections as they are cataloged by the associated scroll or wheel manufacturers.
- **{Open Frame}** - places the frame in Open White. Generally, the first media frame is open.
- **{Cancel}** - cancels the media selection and returns to the frame editor.

When a manufacturer is selected from the list, the catalog selection changes to display only the selected manufacturer's offerings. When a specific catalog is selected, the selected media will display.

When you make a media selection, the display returns to the new wheel frame list where additional frames can be edited in the scroll or wheel.

## Scroller Fan Curves

Curves can be applied to the scroller fan parameter allowing for the output of the fan to be controlled by the intensity of the channel. The curves available for this are the same used for intensity parameters and cues. See [Applying a Curve To Scroller Fans \(on page 381\)](#).

To set a curve to a scroller fan, go to **Displays>Patch>Attributes>Fan Curve** for each scroller.

## Calibrating a Scroller Using the Encoders

You can calibrate the center point of any frame in a scroller using the calibrate feature. Calibrating a scroller is normally done from the live display. You can also calibrate using the ML display. See [Calibrating a Scroller Using the ML Display \(below\)](#).

On Element 2, you will need to use the ML display.



**Note:** *It is recommended that you calibrate your scroller frames starting with the last frame and working backward to the first frame. This will help ensure a complete and accurate calibration.*

---



**Note:** *Calibration may need to be performed when you initially patch a scroller and may need to be adjusted through the course of operation as spring tension changes in a color scroller.*

---

To calibrate a scroller:

1. Select the channel of the scroller you wish to calibrate.
2. Press the **[Color]** encoder button. Multiple presses may be required before the scroller encoder is visible in the encoder LCD.
3. Use the encoder to move all the way to the last frame of the scroller.
4. Continue adjusting the frame in fine mode until the frame is centered in the desired position.
5. Press **{Calibrate}** in the encoder LCD. The new center position is now stored for the selected channel.
6. Press **{Last}** in the encoder LCD to move to the center point of the previous frame.
7. Visually verify if the center point of the new frame is accurate. If it is, press **{Last}** again to move to the previous frame in the scroll. If not, follow the calibration procedure again.
8. Repeat steps 4 through 8 until you have calibrated all of the frames

## Calibrating a Scroller Using the ML Display

You can calibrate the center point of any frame in a scroller using the calibrate feature. This will ensure that color scroll frames will be centered over the aperture of the fixture when you advance a color scroll frame-by-frame. You can do this using the ML Controls display. See [Moving Light Controls \(on page 77\)](#) for more information.



**Note:** *It is recommended that you calibrate your scroller frames starting with the last frame and working backward to the first frame. This will help ensure a complete and accurate calibration.*

---



**Note:** *Calibration may need to be performed when you initially patch a scroller and may need to be adjusted through the course of operation as spring tension changes in a color scroller.*

---

To calibrate a scroller:

1. In the Live display, select the scroller channel.
2. Open the ML Controls from the home screen or by using [Tab] [5].

On Element 2, you can open the ML Controls by pressing [ML Controls].

The color category will display automatically with the Hue and Saturation and scroller encoders and a frame picker open. If the scroller encoder isn't open, click the {Scroller ::} button.

3. To begin calibrating, use the scroller encoder to adjust the centerpoint of a frame. It is recommended that you start with the last frame in the scroll.
4. When the frame is centered, click {Calibrate}.
5. Repeat for any remaining frames that need to be calibrated.

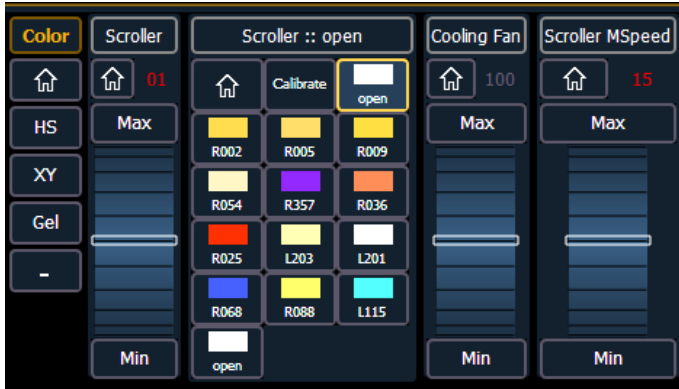

## Scroller Calibration Column

Calibration information will be displayed in the scroller calibration column. Values in gray are the default data, and the values in blue are calibrated data.

#	Name	Calib	C/G	scroller	A & O Scroll	A & O Scroll 2	ADB Scroll	ETC Scroll
1	Generic open open	0		ETC Wybron	Martin Scroll 2	Showtec Scroll	Wybron Scroll	
2	Rosco R002 bastard am...	24						
3	Rosco R005 rose tint	39						
4	Rosco R009 pale amber ...	58						
5	Rosco R054 special lave...	78						

The displayed calibration information is the DMX level that puts the frame into its center position. Information in the calibration column can be manually edited by clicking on it and typing in a new DMX level.



**Note:** Calibration data will only be applied to scroller wheels that are assigned to a channel. Data will not be displayed when viewing a wheel with an empty command line.



**Note:** Calibration data can be returned to its default by clicking on the data and pressing **[Clear]**. If you are entering in new data and hit **[Clear]**, the data will return to the default and not any previously calibrated data.

Pressing the softkey **{Clear Calib}** will clear out the calibration data for the whole scroller wheel, returning it to the default data.

Scroller wheels and their calibration data can be copied to other channels.

- **[1] {Copy Scroller} [2] [Enter]** - copies the scroller and calibration data from channel 1 to channel 2.

Scrollers that have calibrated data will display a “~” after their name.

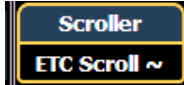

The **{Calibrate}** button will now only appear on scroller parameters that are currently not at the center of a frame.

## Reordering Shutters

Shutters can be reordered in the Patch **{Attributes}** page. Press the **{Shutter Order}** button to open the shutter order display. The **{Shutter Order}** button will only display if a channel with shutters is currently selected.

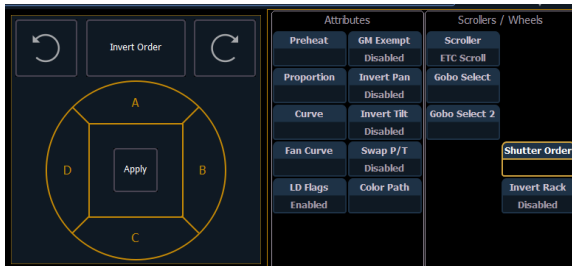

In this display, you can invert the **{Shutter Order}** or rotate the order using the arrow buttons. After you have created the order needed, press **{Apply}** for your changes to take effect.

## Invert Rack

An **{Invert Rack}** option is available in **Patch>Attributes>Scrollers/Wheels**. This option will only display when a fixture with a shutter frame assembly parameter is selected.

The shutter frame assembly parameter allows for the shutter assembly to be turned. When **{Invert Rack}** is disabled, a encoder will move the frame assembly from the right. When enabled, the frame assembly will move from the left.

## Settings in Patch

Softkeys available for use while in patch include **{Patch}**, **{Attributes}**, and **{Database}**. Pressing any of these softkeys opens a paged view of the patch display and redraws the CIA to an expanded view of fields related to the selected page.

When creating and editing your patch, page through each of these softkeys individually to enter more specific data about your selected device.

## {Patch} Display and Settings

With patch open, Eos defaults to this display. It provides access to data input fields that you may use to define devices in your lighting system.



**Note:** *The Artnet and sACN offset will display here.*

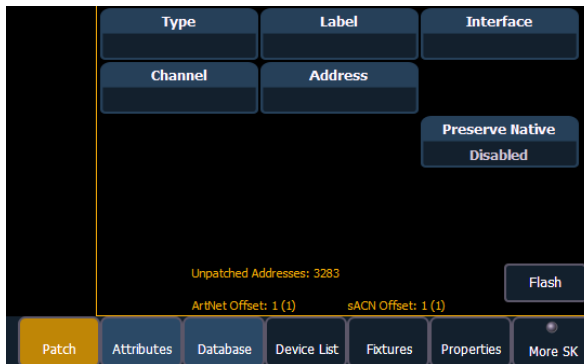

- **{Channel}** - In the patch display, all channels are displayed in numerical order. When multiple devices are patched to the same channel, the channel number is only displayed in the first row, additional devices are indicated with part extensions (example P2) on the next row of the table.
- Select the channel number using the control keypad or the direct selects.
- **{Type}** - Eos defaults to patching dimmers. To specify a specific device type for the selected channel, press the **{Type}** button from the CIA.
- The two columns on the left side of the CIA are pageable and show manufacturer names. The four columns to the right of the manufacturer's list are pageable devices that are available from the selected manufacturer for patching.
- Selecting a specific manufacturer repaints the display with all devices that are available from that manufacturer. After you select a device, the fixture/ device type appears in the command line, in the **{Type}** box in the CIA, and in the "Type" field for that channel in the patch display.
- **{Label}** - An optional user-defined label. You can use the **[Label]** key to display the virtual PC keyboard on the CIA. Pressing **{Label}** or **[Label]**, after a label has already been assigned, will display the label on the command line for editing purposes. Pressing **[Label]** **[Label]** will clear the text.
- **[1] [At] [5] [Label] <S4 house right> [Enter]** - patches channel 1 to output 5 and labels channel 1 as "S4 house right".
- **{Address}** - Required for DMX control of devices. You may use the either the **[At]** or **[Address/Patch]** key instead of the **{Address}** button.
- Use the keypad to define the starting address for the device (from 1 to 32,767,488) or a port and offset value. You may enter a start address without defining an end address.
- Eos will draw this information from the library data. If you wish to leave a larger output gap than required by the library, use **{Offset}**. See [Using {Offset} in Patch \(on page 111\)](#).
- If you specify a start address that conflicts with other channels already patched, the conflicting channels will be unpatched after a confirmation is provided by the user.

- **{Interface}** - An optional field used to specify what protocols and interfaces should be used for the output. When the field is left blank, the default data output is used as selected in the **{Network}** section of the ECU and **{Outputs}** section of Setup. For more information about setting defaults see [Output Protocols \(on page 463\)](#) and [Outputs \(on page 157\)](#). The interface options available are sACN, Net 2- EDMX, ArtNet, Avab UDP, and Local DMX, depending on what has been enabled in the **{Network}** and **{Local I/O}** sections of the ECU for the desk. If an output option is not enabled, it will appear grayed out in the **{Interface}** list.
- **{Preserve Native}** - When Preserve Native is enabled, and you make changes to patch, your cues' real world levels (like pan degrees) will be converted so that the DMX output is preserved instead of the degrees. This is primarily useful for fixture substitutions.
- **{Flash}** - will bring a channel or address to full, and then every other second the level will move to 15%. That will hold for 1 second, and then the level will return to full. The channel or address will keep flashing until either the command line is cleared or **{Flash}** is selected again.

## {Attribute} Display and Settings

The **{Attributes}** page provides you with optional fields for additional information and details about the configuration of your rig. Attribute settings include **{Preheat}**, **{Proportion}**, **{Curve}**, **{Fan Curve}**, **{LD Flags}**, **{GM Exempt}**, **{Invert Pan}**, **{Invert Tilt}**, **{Swap P/T}**, and **{Color Path}**.

With no channels selected, **Scrollers / Wheels** will display scroller and wheel parameters for any patched fixtures. With one or more channels selected, only the parameters that apply to those fixtures will appear. Press the desired attribute button and use the keypad to set the attribute value.



- **{Preheat}** - This field allows you to specify an intensity value to preheat incandescent filaments. When a preheat flag is applied to a cue, any channels that are fading from zero to an active intensity and have been assigned a preheat value in patch will preheat in the immediately preceding cue. The preheat flag is applied to a cue as an attribute when the cue is recorded.
- **[1] {Preheat} [0] [3] [Enter]** - channel 1 is assigned a patched preheat value of 3%.
- **{Proportion}** - An attribute to set a modifier for the intensity of the device. If the patch limit is set at 90% (for example), the actual output will always be 10% lower than the specified intensity parameter, as impacted by the various playbacks or submasters. This value is set numerically in a range of 0% to 200%.
- **[1] {Attributes} {Proportion} [1] [2] [5] [Enter]** -applies a 125% proportion to channel 1.
- **[1] {Attributes} {Proportion} [Enter]** - removes the applied proportion from channel 1.



- **{Curve}** - Used to assign a curve to a channel in Patch. In Patch, curves can be applied to intensity parameters, or to non-intensity parameters using the NP buttons. See [About Curves \(on page 378\)](#) for more information.

From channel view:

- **[1] {Curve} [4] [Enter]** - applies curve 4 to the intensity parameter of channel 1.
- **[2] [Part] [3] {Curve} [3] [Enter]** - applies curve 3 to the intensity assigned to channel 2, part 3.

From address view:

- **[3] {Curve} [3] [Enter]** - assigns curve 3 to address 3.
- **[3] [/] [2] {Curve} [4] [Enter]** - assigned curve 4 to universe 3, address 2.
- **{Fan Curve}** - Used to assign a curve to the scroller fan parameter, which allows for the output of the fan to be controlled by the intensity of the channel. Curves available for this are the same used for intensity parameters and cues.



**Note:** When **{Curve}** or **{Fan Curve}** is pressed, a list of the available curves will be displayed. Clicking on an available curve will assign it.

---

- **{LD Flags}** - This field allows channels to contribute to live and dark move flags in the playback status display. Disabling will prohibit those channel moves from contributing to the live and dark move flags. This is enabled by default.
- **{GM Exempt}** - Used to exempt the intensity of channels from grandmaster, blackout, rem dim, and go to cue 0 operations.
- **{Invert Pan} {Invert Tilt}** - A moving light attribute used to invert the output of pan, tilt, or both. Select either the **{Invert Tilt}** or the **{Invert Pan}** button on the CIA.
- **[2] {Attributes} {Invert Pan}** - inverts the output of the pan parameter on channel 2.
- **{Swap P/T}** - A moving light attribute used to exchange pan and tilt levels. Select the **{Swap}** button on the CIA.
- **[2] {Attributes} {Swap}** - swaps the pan and tilt parameters for channel 2.
- **{Color Path}** - A default Color Path can be assigned at the channel level in Patch. That color path will be used for all of that channel's color fades unless overridden at the cue level. Submasters and manual transitions that use that channel will use the default color path as well. See [Color Path \(on page 187\)](#)
- **[1] [Path] [2] [Enter]** - will assign color path 2 to channel 1.
- **{Scrollers}** - An attribute used to change the scroll loaded in a scroller or moving light. Select the **{Scrollers}** button on the CIA to display the scroller picker and the scrolls available for your device. See [Using the Picker \(on page 116\)](#)
- **[2] {Attributes} {Scrollers}** - opens the Scroller Picker in the CIA for scroll selection for channel 2.
- **{Color Wheels}** - An attribute used to change the color wheel loaded in a moving light. Select the **{Color Wheels}** button on the CIA to display the wheel picker with the options available for your device. See [Using the Picker \(on page 116\)](#) "More" as shown in the patch display, indicates additional parameter properties are available for the selected device, such as the color and gobo wheels.
- **[4] {Attributes} {Color Wheels}** - selects channel 4 and opens the wheel picker in the CIA for color wheel selection.
- **{Gobo Wheels}** - An attribute used to change the gobo wheel loaded in a moving light. Select the **{Gobo Wheels}** button on the CIA to display the wheel picker with gobo options available for your device. See [Using the Picker \(on page 116\)](#)

- **[3] {Attributes} {Gobo Wheels}** - selects channel 3 and opens the Wheel Picker in the CIA for gobo wheel selection.
- **{Effect Wheels}** - An attribute used to change the effect wheel loaded in a moving light. Select the **{Effect Wheels}** button on the CIA to display the wheel picker with the options available for your device. See [Using the Picker \(on page 116\)](#) “More” as shown in the patch display, indicates additional parameter properties are available for the selected device, such as the color and gobo wheels.
- **[5] {Attributes} {Effect Wheels}** - selects channel 5 and opens the wheel picker in the CIA for effect wheel selection.

## {Database} Display and Settings

The **{Database}** page provides you with additional fields for entering information that can be used by the Query function. See [Using \[Query\] \(on page 300\)](#). These fields include **{Notes}** and **{Text 1}** through **{Text 10}**. Clicking on **{Text 1}** through **{Text 10}** will open up a display for selection of keywords. It will display keywords that were already created as well as showing an option for creating new keywords. Clicking on **{New Keyword}** will display an alphanumeric keyboard for entering in a new keyword.

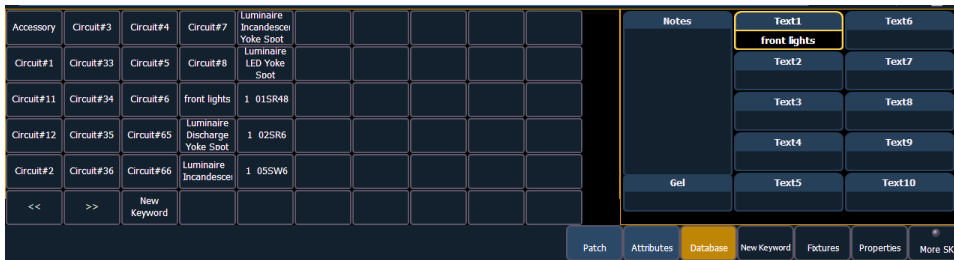

- **{Text}** - Text fields are used to provide up to ten keywords about any channel or group of channels. These fields can be anything that you think is important about a channel, such as its location (FOH), an attribute of it (wash, spot) or other characteristics of the channel (such as gel R80). You may use the virtual keyboard in the CIA, or an external keyboard, to provide up to 30 characters of key words about the device.
- **[5] {Database} {Text 1} < FOH right> [Enter]** - adds text to channel 5.
- **[5] {Database} {Text 2} [Label]downstage right [Enter]** - adds text to channel 5.
- **{Notes}** - Provides you the ability to attach a text note to a channel or group of channels. Select the **{Notes}** button on the CIA to display the virtual keyboard. You may type a label or any length of note regarding your channel in this space.
- **[5] {Database} {Notes} <this fixture is a backup to channel 15 for front of house right / new lamp installed on 10/4/17> [Enter]** - adds a note to channel 5.
- **{Gel}** - The Gel field is a dedicated location for notes about gels.

## Adding Keywords in Patch

If you plan on being able to query channels based on a keyword association, the keyword must be defined in patch.

To enter a keyword for a channel:

1. In **Patch > Database**, select a channel or range of channels in the command line.
2. Touch one of the **{Text (1-10)}** touchbuttons in the CIA to specify which keyword you are entering. A list of previously defined keywords will be posted. Select from these or press **{New Keyword}**. A virtual alphanumeric keyboard will appear.

3. Type the keyword or words you wish to use.
4. When finished, press **[Enter]**.

Once keywords have been created, they will appear in the keyword section of the CIA when a query is performed. For more information on keyword queries see [Using \[Query\] \(on page 300\)](#).

### **Deleting Keywords from the Database**

Keywords can be deleted from any of the ten text fields in the database. To delete a keyword from the entire database, you would use the following syntax:

- **[Delete] {Text1} <orange> [Enter] [Enter]**

This will delete orange anywhere it was used in any text field of any channel.

To just remove a keyword from a specific channel, you would use the following syntax:

- **[1] {Text1} [Enter]**

That would remove the text from channel 1's first text field only. If you wanted to clear the second text field, you would select **{Text2}** and so on.

### **Renaming Text Fields in Patch**

You can rename the text fields. By default, the text fields are named **{Text 1}** through **{Text 10}**. Text fields 1 through 10 display in the Patch display. Renaming those fields will rename the columns associated with them in the Patch display.

- **{Text 1} [Label] <Position>** will rename the text 1 field to Position.

## **Using Device List**

The Device List is used to discover, configure, and monitor compatible Remote Device Management (RDM) and network devices. RDM allows for bi-directional communication between a RDM compatible device, such as a lighting fixture, and your desk.

Two lists, dimmer and RDM, make up the device list.

The dimmer list is the area of patch that handles setting up dimmer feedback from CEM+, CEM3, and FDX 2000/ 3000. You can also do some configuration of dimmers from this list.

The RDM List is the area of patch that handles RDM feedback with devices. You can also do some configuration of devices from this list. Once RDM compatible devices have been patched, they keep communicating with the console to allow you to know when things like blown lamps happen or if a device goes offline for some reason. See [RDM Device List \(on page 129\)](#)

The Device List displays all discovered devices during the current session and all devices that have been stored in the show file.



**Note:** Consoles only support RDM devices that are connected through a Gadget, Local I/O, or external ACN gateway (running version 5.1 or higher).

---

### **Dimmer List for CEM+, CEM3, and FDX 2000/3000**



**Note:** For Dimmer Feedback, these software versions are required: CEM+ v3.0 and newer, CEM3 v1.3.1 and newer, and FDX v3.4.0 and newer.

---

To use the Dimmer Feedback area of the Device List, you must first enable feedback. In the network tab of the ECU, when using CEM+ or CEM3, make sure **{Sensor/ FDX3000 Feedback}** is enabled, or when using FDX 2000/ 3000, make sure that **{Sensor/ FDX3000 Feedback}** or **{FDX2000 Feedback}** is enabled. The default setting is disabled for both. See [Interface Protocols \(on page 464\)](#)

Open the Dimmer Feedback display while in the Patch display by pressing **{Device List}> {Dimmers}**. When the dimmer list is opened, the dimmers will be displayed in Patch by Address mode.

Properties											Loads
Address	Chan	Label	System	Rack	Lug	Module Type	Firing Mode	Control Mode	Curve	Rec Load	
3585		Eos Lab 1	2	101	1	D20	Normal	Dimmable	Mod Square		
3586		Eos Lab 2	2	101	2	D20	Normal	Dimmable	Mod Square		
3587		Eos Lab 7	2	101	3	D20	Normal	Dimmable	Mod Square		
3588		Eos Lab 8	2	101	4	D20	Normal	Dimmable	Mod Square		
3589		Eos Lab 13	2	101	5	D20	Normal	Dimmable	Mod Square		
3590		Eos Lab 14	2	101	6	D20	Normal	Dimmable	Mod Square		
3593		Eos Lab 25	2	101	9	D20	Normal	Dimmable	Mod Square		
3594		Eos Lab 26	2	101	10	D20	Normal	Dimmable	Mod Square		
3595		Eos Lab 31	2	101	11	D20	Normal	Dimmable	Mod Square		
3596		Eos Lab 32	2	101	12	D20	Normal	Dimmable	Mod Square		
3597		Eos Lab 37	2	101	13	D20	Normal	Dimmable	Mod Square		
3598		Eos Lab 38	2	101	14	D20	Normal	Dimmable	Mod Square		
3599		Eos Lab 43	2	101	15	D20	Normal	Dimmable	Mod Square		
3600		Eos Lab 44	2	101	16	D20	Normal	Dimmable	Mod Square		
3601		Eos Lab 49	2	101	17	D20	Normal	Dimmable	Mod Square		
3602		Eos Lab 50	2	101	18	D20	Normal	Dimmable	Mod Square		
3603		Eos Lab 55	2	101	19	D20	Normal	Dimmable	Mod Square		
3604		Eos Lab 56	2	101	20	D20	Normal	Dimmable	Mod Square		

Eos will display the following information that it receives from the dimmers:

- Address
- Channel
- Label
- System
- Rack
- Lug
- Module Type
- Firing Mode
- Control Mode
- Curve
- Recorded Loads



**Note:** The System ID number from CEM3 is not currently supported.



**Note:** Rack numbers and dimmer numbers need to be unique for Eos to properly recognize them. For CEM+, dimmers also need to be patched to different sACN addresses.

With a dimmer or dimmers selected, you can edit various dimmer settings in the property view, which will display in the CIA. Items with a caret (>) are editable. When multiple dimmers are selected together for editing, an "\*" will show for data that is different between the selected dimmers.

Dimmer Feedback	Value
Label	Eos Lab 1
Module Type	D20
System/Rack/Lug	2/101/1
Rack Dimmer Level	0%
Rack Dimmer Source	No Source
Recorded Load	Not Recorded
Actual Load	328.56 Amperes
Firing Mode	> Normal
Control Mode	> Dimmable
Curve	> Mod Square
Threshold	> 1%
Scale Minimum	> 0 Volts

Set Dimmer

Unset Dimmer

Dimmers

FDX dimmers will not display data for the following:

- Recorded Load
- Actual Load
- Rack Dimmer Source
- Threshold
- Scale Minimum
- Preheat Enable
- Preheat Timing
- AF Enable



**Note:** When dimmers are discovered, they are not automatically attached to patched channels in Eos; you must attach a dimmer to a channel. See [Patching Discovered Dimmers and RDM Devices \(on page 131\)](#)

## RDM Device List

Before you can start using the RDM Device List, you must first enable {RDM} for the appropriate DMX ports in **Setup > System > Output**, or for the appropriate ethernet ports in the Network ECU tab. By default RDM is disabled. See [Outputs \(on page 157\)](#) or [Interface Protocols \(on page 464\)](#) If using Network RDM, this must be done via an ETC Net3 Gateway and RDM must also be enabled on the DMX ports of the Gateway. The Gateway needs to be running version 5.1 or newer.

Open the RDM Device List while in the patch display by pressing {Device List}> {RDM}.

You will need to make sure that {Device Discovery} is enabled.

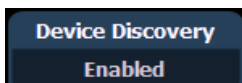

{Device Discovery} is disabled by default. The {Device Discovery} option will not display if {RDM} is disabled in the ECU.



**Note:** {Device Discovery} will automatically disable when you leave the patch display.

When the RDM device list is opened, the devices will be displayed in Patch by Address mode. At the top of the list is a RDM indicator. This indicator shows incoming and outgoing RDM traffic.

Address	Chan	Label	Manufacturer	Model	Footprint	Eos Type
12-15	1	RDM Label	ETC	S4 Ser2 Lustr	4	HSI
23-30	2	RDM Label	ETC	Desire Lustr+ 60	8	Direct
35	3	RDM Label	ETC	Source 4 Tungsten	1	Direct

Eos will display the following information that it receives from the RDM devices:

- Address (a part will be added if multiple devices are discovered with the same address)
- Channel
- Label
- Manufacturer
- Model
- Footprint

Eos will also display what personality from the library the device matches in the Eos Type column. This information will not display until you first select the device. Once the device has been selected for the first time, Eos will extract the type information from the device and display it.

- The following messages may display in the Eos Type column:
  - No RDM Data Available - no model specific RDM data has been extracted from the device.
  - Extracting RDM Commands - currently getting the command data from the device.
  - Extracting RDM Fixture -currently getting the data required to create a fixture definition for the device.
  - Extracting RDM Sensors - currently getting the sensor definitions from the device.
  - Offline - no model specific RDM data has been extracted from the device and it is now offline.

With a device or devices selected, you can edit various device settings in the property view, which will display in the CIA. Items with a caret (>) are editable. When multiple devices are selected together for editing, an "\*" will show for data that is different between the selected devices.

Device Property	Value
Device Model Description	Source 4 Tungsten
Manufacturer Label	ETC
Device Label	> RDM Label
Software Version Label	1.6.0.9.0.09
DMX Personality	> Direct
DMX Start Address	> 35
Identify Device	> Off
Preset Playback	> Off / 100%
LED Curve	> Standard
LED Strobe	> Off
LED Output Mode	> Regulated

The following buttons will also display in the property view:

- **{Device Properties}** - opens the properties list for the selected RDM device.
- **{Sensors}** - displays if the selected device has sensors. Pressing **{Sensors}** will open the sensors list.
- **{Lamp Controls}** - displays if the selected device has lamp controls. Pressing **{Lamp Controls}** will open the lamp controls list.
- **{Channel}** - channel number of the selected device.
- **{Address}** - address of the selected device.

- **{Device Discovery}** - allows for discovery of RDM devices.
- **{Ignore Errors}** - when enabled, errors messages will not display in the live/blind displays. They will still display in about and the properties display in patch.
- **{Reload RDM Data}** - deletes the fixture data from the desk and reloads it from the device.
- **{Flash}** - triggers the identify function of the RDM device. The identify function may defer between different manufacturers' devices. For example, Wybron scrollers identify by wiggling their gel back and forth.
- **{!}** or **{?}** - displays if selected device has errors. Pressing **{!}/{?}** will open the error list.



## Patching Discovered Dimmers and RDM Devices

When dimmers/devices are discovered, they are not automatically attached to any patched channels in Eos. If you want the benefits of dimmer or RDM feedback, you must attach a dimmer or device to a channel.

If you patch a dimmer/device's address to a channel, while in the device list display, the dimmer/device will be automatically attached to that channel. However, if you patch outside of the device list, you will need to **{Attach}** the device to the channel.



**Note:** *If the dimmer/device's address is not yet used in the patch, it is easiest to patch the address to a channel in the dimmer list or device list screen.*

<Chan> [X] **{Attach}** or <Address> [X] **{Attach}** will link that channel/address in patch and the dimmers/devices at that address.

When a channel number is attached to a dimmer/device, by patching it or using **{Attach}**, the channel's fixture type is changed to the dimmer or device fixture type.

The advantages of attaching a dimmer to a channel are:

- The desk warns you when a channel's attached dimmer has an error or is offline.
- Items that are attached between patch and the device list will display a caret (>) beside their channel/address in patch.

The advantages of attaching a device to a channel are:

- Its fixture type is copied to the channel.
- The desk warns you when a channel's attached device is offline or has an error.
- The device will always appear in the device list display, even if the device is offline.
- Items that are attached between patch and the device list will display a caret (>) beside their channel/address in patch.

## Errors and Warnings

One of the advantages of using dimmer and RDM feedback is error and warning reporting. If something happens with a patched and attached dimmer/ device, you will be notified in live, patch, and about.

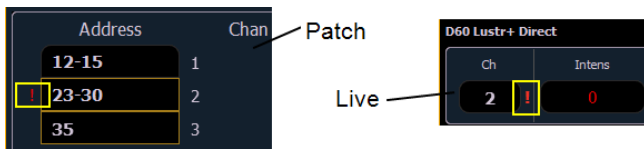

Errors can be viewed in the About Channel and About Address displays.

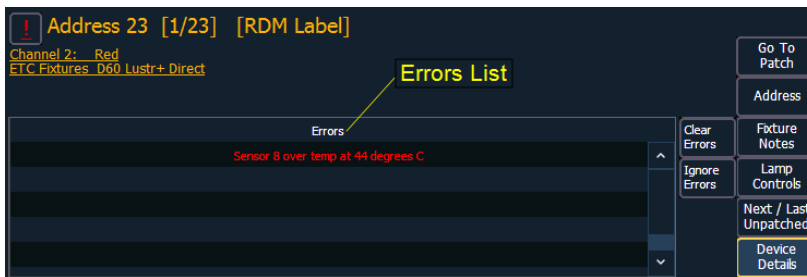

The notifications you can see are:

- A red “!” means that the dimmer/ device has errors, such as overtemp, breaker trip, and lamp out.
- Yellow “?” means that the dimmer/ device has a warning message. Warning messages can include:
  - Multiple devices’ addresses overlap
  - Multiple devices or different devices at this address
  - Patched fixture type mismatch
  - Patched fixture address mismatch
  - Offline

## Detaching Devices

Pressing {Attach} twice will post the {Detach} command.

<Chan> [X] {Attach} {Attach} or <Address> [X] {Attach} {Attach} will remove the link between that channel/address and the device at that address.



## Clearing the Patch

You can clear the patch entirely by accessing the clear functions from **Browser> Clear**. The clear functions window will open in the CIA.

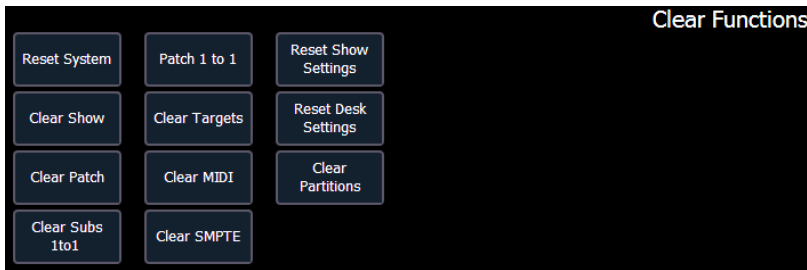

To clear the patch, click **{Clear Patch}**. A confirmation is required before the patch will be cleared.

To create a 1-to-1 patch, click **{Patch 1 to 1}**. This will remove the current patch.

To exit the clear functions screen without clearing, press the **[Displays]** key at any time or select a clear button and then select **{Cancel}** from the confirmation screen.

## Update Profile

When a new library is installed on Eos either from a software update or a separate fixture library file from the ETC website, changes in library data will not automatically update your show files. This is to prevent library changes from affecting a functional show file.

Using the **{Fixtures}** softkey in patch will open up the list of fixtures used in the current show file. In this view, you will be able to tell which fixtures in the currently loaded show file differ from the desk's fixture library. Fixtures that have either been edited or their profile does not match the current library will display with an "\*" beside their name. For fixtures that have a library update, the **{Update Profile}** softkey will display in white, and for fixtures that don't have an update, the **{Update Profile}** softkey will be grayed out.



**Note:** When updating a fixture in Patch, a warning message will display that includes what changes will be made to the fixture by updating it. Press **{Ok}** to update the profile or **{Cancel}** to return to the fixture editor.

---



**Note:** For multiconsole systems, all devices have to use the same fixture library. If the fixture library is different between devices, a warning will be displayed on the device trying to connect to the system.

---

## Fixture Editor

Eos provides you with the ability to create your own fixture type within patch and store it with your show file. You can name the fixture, assign all necessary parameters, define the address and operational range of those parameters, see fixture modes and their properties, and set lamp controls.



**Note:** Before you create a new fixture, it is helpful to look at a few fixture personalities of similar fixtures to get an idea of how to set yours up. You may even want to look at their user manuals to see how their defined DMX footprints look as a fixture profile. This is especially helpful when creating **modes**.

---

The fixture creator is accessible from patch. Once a fixture has been created, it is stored in the show file. It is **not** added to the fixture library. If you want to use the created fixture in another show file, you will need to use merge. See [Merging Custom Fixtures into a New Show File \(on page 147\)](#)

If you would like to remove any unused fixtures from this list, press **{Delete Unused}**.

To open the fixture editor:

1. Press **[Address/Patch]** twice or **[Displays]> {Patch}** to open the patch display.
2. Press the **{Fixtures}** softkey. This will open a list on the left displaying those same fixtures that are currently patched or have been added to the show, and the list on the right are the parameters for the selected fixture. This is the fixture editor.

Type	DMX Footprints	Cell	SolaSpot Frame 2000					
Coloram 2 Scroller *	1		DMX Footprint: 48 Parameter Count: 52					
Dimmer *	1		Create Multicell <input type="checkbox"/> Remote Dimmer <input type="checkbox"/>					
Mac 700 Profile Basic *	23		#	Parameter	DMX	Home	Snap	Ranges
Mac 2000 Profile 16b *	24		1	Pan	Focus 16b: 1, 2	32768		2 Ranges
new fixture(1)	17		2	Tilt	Focus 16b: 3, 4	32768		-132 > 132
Revolution RWM/RWM(Revolution RWM...	23		3	Color Mix Mode	Color	8b: 5	15	4 Ranges
Revolution RWM/RWM Copy(1)	23		4	Cyan	Color	8b: 6	255	0 > 100
Sensor Dimmer 8B	1		5	Magenta	Color	8b: 7	255	0 > 100
SolaSpot Frame 2000	48		6	Yellow	Color	8b: 8	255	0 > 100
SolaSpot Pro 2000	43		7	CTO	Color	8b: 9	255	0 > 100
Studio Spot 575 CMY *	24		8	Color Wheel Mode	Color	8b: 10	55	7 Ranges
VL3500 Spot *	31		9	Color Select	Color	8b: 11	0	5 Modes
			10	Gobo Wheel Mode	Image	8b: 12	7	6 Ranges
			11	Gobo Select	Image	8b: 13	0	4 Modes
			12	Gobo Mode	Image	8b: 14	7	6 Ranges
			13	Gobo Index/Speed	Image	16b: 15, 16	32767	5 Modes
			14	Gobo Wheel Mode 2	Image	8b: 17	7	6 Ranges
			15	Gobo Select 2	Image	8b: 18	0	4 Modes

## Creating a New Fixture

New fixtures are created from the fixture editor. You can either create a new fixture, or copy an existing fixture to edit. See [Copying a Fixture \(on page 147\)](#)

To create a new fixture, press **{New}**. A new fixture will be added to the fixture list.

## Naming a New Fixture

Once the new fixture appears in the list, it is recommended that you name the fixture you are about to create.

To name a fixture in the creator list:

1. Use the **[Page]** keys, mouse, or touchscreen to select the new fixture.
2. Press **[Label]** or tap on the new fixture. You can press **[Label]** twice to clear the name. The virtual keyboard will open in the CIA.
3. Enter the desired name for the new fixture on the virtual (or attached alphanumeric) keyboard.
4. Press **[Enter]**. The name will appear in the “Type” column of the fixture list.

## Adding Parameters

After naming the fixture, you can specify which parameters the new fixture contains.



**Note:** For 16b parameters, LDMX or “low-DMX” is the DMX address for the second half of any 16-bit channel. If used in Coarse/ Fine determination, the DMX channel defines the “Coarse” adjustment and the LDMX defines the “Fine” adjustment. Do not count 16-bit parameters as two parameters, this will be done in a later step.

To add parameters to a new fixture:

1. Use the [Page] keys, mouse, or touchscreen to select the new fixture.
2. Select the parameter list by clicking on it or touching it.



3. Determine the total number of parameters that your fixture has. Do not count 16-bit parameters as two parameters, this will be done in a later step.
4. Press {New} or {+} to add parameter slots. Repeat this step until you have as many slots as are required by the number determined in step 3.



**Note:** When {New} or {+} is pressed, the parameter slot will appear in the list with a default name in the "Parameter" column. You may disregard these default parameters as you will redefine the designations in a later step.

5. Use the [Page] keys, mouse, or touchscreen to navigate to any parameter slots that you wish to alter the default parameter designations for.
6. Click on the slot to open a dropdown list of available parameters.

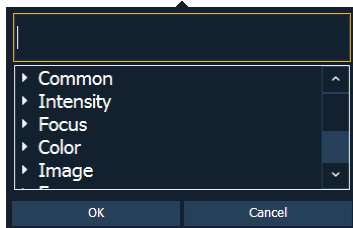

7. Click on a category to open the dropdown list to see the parameters, or use the search box to find the parameter.

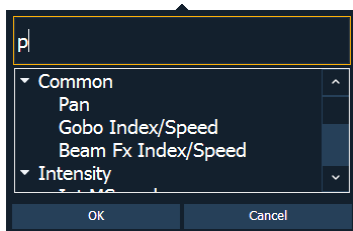

8. Press the desired parameter to assign it or press [Enter] when the parameter is selected.
9. Repeat steps 5 through 8 until you have entered all of the required parameters for the new fixture.

**If you are missing a parameter slot:** At any point you can use the **[Page]** keys and **{Insert}**, to insert a parameter slot above the selected one.

**If you want to remove a parameter:** you can use the **[Page]** keys and **{Delete}**, to remove a parameter from the list.

## Locked Value

A parameter can be assigned as a locked value. When used, the output address and value will be locked at the profile level. This option is available under Control in the parameter dropdown list.

## Define Parameters

Once you have added and specified all of the parameters for the new fixture, you can now define the address requirements, size, and ranges for each of them.

To define the size (8-bit or 16-bit), DMX address, and LDMX address of any parameter:

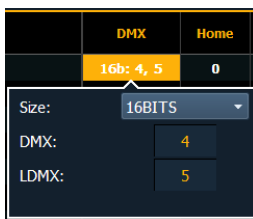

You can alter the default DMX address assigned to any parameter in the list. This is not the actual address that will be used when patched, but rather it is the order of address for the parameter relative to the other parameters in the fixture.

LDMX or “low-DMX” is the DMX address for the second half of any 16-bit channel. If used in Coarse/ Fine determination, the DMX channel defines the “Coarse” adjustment and the LDMX defines the “Fine” adjustment.

1. Use the **[Page]** keys to navigate to any parameter that you wish to alter the size of. The system defaults to 8-bit for any new parameter.
2. When selected, click Size to choose between 8-bit or 16-bit. If 16-bit is selected, the system automatically displays a LDMX option. This value can be altered.
3. Enter the desired address for the DMX and/ or LDMX addresses using the keypad.

To alter the Home settings for any parameter:

You can define the value for any parameter’s “home” value.

1. Click on the “Home” column of the desired parameter.
2. Enter the desired home value (0 through 255 for 8-bit, and 0 through 65535 for 16-bit) using the keypad.

To enable the Snap setting for parameters:

You can enable snap for parameters to exempt them from cue timing, so they snap to their new value. For more information about snap, see [Snap Parameters \(on page 144\)](#)

1. Use the **[Page]** keys to navigate to the “Snap” column of the desired parameter.
2. Click in the “Snap” column for the selected parameter to enable.

## Range editing a parameter

You can enter the operational ranges for specific slots within any specific parameter (such as color scroller, color wheel, gobo wheel, and so on). You can do this by either defining each range individually or you can use the [quick action](#) tools to define multiple ranges at once.

#	Parameter		DMX	Home	Snap	Ranges
1	Intens	Intensity	8b: 1	0		0 > 100
2	Pan	Focus	8b: 2	0		-270 > 270

	DMX			User			Label
	Min	Home	Max	Min	Home	Max	
New							
Insert	Quick Actions...						Quick Labels...
Delete	0	0	255	-270	0	270	
Label	+						
New Mode							
Delete Mode							

If a parameter has only one range, the values for that range will display in the range column. If that parameter has multiple ranges, the number of ranges will be displayed. If a range is used in a [mode](#), the range will not be in bold.

Ranges	
<b>0 &gt; 100</b>	Single Range
<b>0 &gt; 100</b>	
<b>7 &gt; 42</b>	
<b>0 &gt; 100</b>	
4 Ranges	Multiple Ranges Used in a Mode
<b>4 Modes</b>	
<b>0 &gt; 100</b>	
64 Ranges	Multiple Ranges

For example, if the parameter were “Gobo Wheel”, and the fixture included a four-slot gobo wheel, you can use ranges to determine the minimum/ maximum values for each of those slots. You can also label the slots and define the minimum/ maximum values that will appear in the channel display for that parameter.

To define the range values individually for any parameter:

1. Use the **[Page]** keys to navigate to the parameter that you want to add ranges to.
2. Click on the range. The range window will open.
3. Determine the total number of slots required by the parameter. **Be sure to include “open” slots when needed.**
4. Press **{New}** or **{+}** to add ranges. Repeat this step until you have as many slots as are required by the number determined in step 3.
5. Use the **[Page]** keys to select the range and field you wish to edit. Fields are:
  - **DMX Min** - enter the minimum value (0 through 255) for the range slot you are defining.

- **DMX Home** - enter the default value (0 through 255) for the range slot you are defining.
  - **DMX Max** - enter the maximum value (0 through 255) for the range slot.
  - **User Min**- enter the value that will be displayed to users (for example, what will be displayed in the live summary view) when the slot is at its minimum value. Value can range from -32767 to 65535.
  - **User Home**- enter the value that will be displayed to users (for example, what will be displayed in the live summary view) when the slot is at its default value. Value can range from -32767 to 65535.
  - **User Max**- enter the value that will be displayed to users when the slot is at its maximum value. Value can range from -32767 to 65535.
6. Press **{Label}** to add a label to any range slots. These will appear in the encoder display and ML controls when the related parameter is displayed for the new fixture.
  7. Press **{Patch}** when you have finished editing the ranges.

To delete a range value, select it and press **{Delete}**.

## Quick Actions

Quick Actions provides tools that allow for the creation of multiple ranges at once according to predefined actions.



**Note:** *Quick Actions supports 8bit and 16bit parameters.*

---

Click on **Quick Actions** to open the menu. In this menu, you select the desired action and the number of slots needed.

The following actions are available:

- **As-Is** - This is the initial mode. The ranges are unchanged. This allows you to view the range as it was.
- **User Values** - These actions affect the user values. See [Range editing a parameter](#) for more information about user values.
- **Framed** - Enter the number of frames that you would like to have on your collection of ranges. The console then distributes the DMX values and assigns a user range exactly as any of the wheel or frame parameters are automatically created. (Frames 1, 2, 3, etc would be represented as 0.5-1.4, 1.5-2.4, 2.5-3.4, etc)
- **Matched** - The user values are set to match the DMX values. This is required for a virtual parameter (one that has no DMX address) and is used as a **mode** for another parameter.
- **Scaled** - Users can enter the minimum and maximum user value to map their DMX ranges to an arbitrary user range. This is useful when creating pan/tilt ranges (e.g., -180 to 180), or color temperature ranges (e.g., 3000 to 15000). DMX ranges are not changed and are assumed to be as the user intends. The DMX values are scaled into the new user range.
- **DMX Values**- This action affects the DMX values. See [Range editing a parameter](#) for more information about DMX values.
- **Distribute** - Select the number of ranges you wish to create. DMX values are then evenly distributed as specified.

## Quick Labels

Click on Quick Labels to open a dropdown menu with labeling options. These options are broken down into two categories: units and labels.

- **Units**
  - Degrees
  - Percent
  - (none)
- **Labels**
  - Open
  - Open/Color N
  - Blackout
  - Animation
  - Animation N
  - Color
  - Color N
  - Color N/N
  - Color N/Open
  - Effect
  - Effect N
  - Gobo
  - Gobo N
  - (clear)

Units are used to add a degree or percentage symbol to the end of a label when it displays in the encoder display or ML controls. If you want to remove a unit, select **(none)**.

Labels are used to replace the text for all of the ranges. Labels that have an N after them will display the appropriate number in the encoder display or ML controls. For example, Gobo N will display the number of the gobo. Select **(clear)** to remove the labels.

## Modes

A mode is a collection of ranges that will display in the encoder display and in ML controls when the mode's conditions are true. These ranges are part of one DMX address that is used to control two or more different by related functions, such as gobo index and rotate.

Examples of mode conditions are "When Gobo Mode is Indexed" or "When Strobe Mode is Random". Multiple conditions can be assigned. An example of this would be "When Gobo Wheel Mode is Index or Index Scan".

New	Mode	DMX Min	DMX Max	User Min	User Max	Label
Insert	When Gobo Wheel Mode is Index or Index Scan	Quick Actions...				Quick Labels...
Delete		0	65535	-197	197	-197 to 197 D
		+				
Label	When Gobo Wheel Mode is Rot or Rot Scan, Spin + Rot, Spin - Rot	Quick Actions...				Quick Labels...
New Mode		0	65535	-100	100	-100 to 100%
Delete Mode						
Next Mode						
Last Mode						

When viewing a fixture profile, the parameters that have modes will display the number of modes in the ranges column.

Type	DMX Footprint	Cell	SolaSpot Frame 2000					
Coloram 2 Scroller *	1		DMX Footprint: 48 Parameter Count: 52					
Dimmer *	1		Create Multicell <input type="checkbox"/> Remote Dimmer <input type="checkbox"/>					
Mac 700 Profile Basic *	23		#	Parameter	DMX	Home	Snap	Ranges
Mac 2000 Profile 16B *	24		1	Pan	Focus 16b: 1, 2	32768		2 Ranges
new fixture(1)	17		2	Tilt	Focus 16b: 3, 4	32768		-132 > 132
Revolution RWM/RWM[Revolution RWM...]	23		3	Color Mix Mode	Color 8b: 5	15	<input checked="" type="checkbox"/>	4 Ranges
Revolution RWM/RWM Copy(1)	23		4	Cyan	Color 8b: 6	255		0 > 100
Sensor Dimmer 8B	1		5	Magenta	Color 8b: 7	255		0 > 100
SolaSpot Frame 2000	48		6	Yellow	Color 8b: 8	255		0 > 100
SolaSpot Pro 2000	43		7	CTO	Color 8b: 9	255		0 > 100
Studio Spot 575 CMY *	24		8	Color Wheel Mode	Color 8b: 10	55	<input checked="" type="checkbox"/>	7 Ranges
VL3500 Spot *	31		9	Color Select	Color 8b: 11	0	<input checked="" type="checkbox"/>	5 Modes
			10	Gobo Wheel Mode	Image 8b: 12	7	<input checked="" type="checkbox"/>	6 Ranges
			11	Gobo Select	Image 8b: 13	0	<input checked="" type="checkbox"/>	4 Modes
			12	Gobo Mode	Image 8b: 14	7	<input checked="" type="checkbox"/>	6 Ranges
			13	Gobo Index/Speed	Image 16b: 15, 16	32767	<input checked="" type="checkbox"/>	5 Modes
			14	Gobo Wheel Mode 2	Image 8b: 17	7	<input checked="" type="checkbox"/>	6 Ranges
			15	Gobo Select 2	Image 8b: 18	0	<input checked="" type="checkbox"/>	4 Modes



**Note:** When adding a new mode, you will need to first add the parameter that the mode needs to be associated with before you will be able to assign the mode. See [Creating Modes \(on the facing page\)](#).

Modes can be edited in the [range editor](#). The following buttons are available for editing modes:

- **{New Mode}** - adds a new mode.
- **{Delete Mode}** - deletes the selected mode.
- **{Next Mode}** - advances your selection to the new mode.
- **{Last Mode}** - returns your selection to the previous mode.

Clicking a new or existing mode will open the mode selection window.

▶ 34+35: Edge
▶ 36+37: Zoom
▶ 38: Iris
▼ 39: Strobe Mode
✓ Strobe Mode: Strobe (0>31)
Strobe Mode: Random (32>63)
Strobe Mode: Rnd Sync (64>95)
Strobe Mode: Strobe 2 (96>255)
▶ 41+42: Intens
▶ 43: Intensity Macros
▶ 44: Intensity Macro Rate
▶ 45: Intensity Macro Crossfade Rate
▶ 46: Global MSpeed
▶ 47: Macros
▶ Virtual: Animation Wheel Mode
▶ Virtual: Hue
▶ Virtual: Saturation
▶ Virtual: Brightness
▶ Virtual: Frame Thrust A

9	Delete Mode	When Strobe Mode is Random	0	23
1	Next Mode		24	229
31	Last Mode		230	255

This window displays all the possible conditions that can be applied to the fixture. The active ranges for the mode will already be selected with a checkmark.

A condition can only be present on a single mode. Similarly, if a parameter has multiple ranges, and it is selected as a condition for another parameter, all ranges need to be present on some modes of the fixture. For example, if gobo wheel has ranges of index, rotate, and shake, and you place index on a parameter for a mode, rotate and shake must also be used.

Once a parameter is used as a condition, it becomes read only. Only the labels for the ranges can be added/ edited.





**Note:** A single range parameter is not useful as a condition so those will not be available for selection.



**Note:** Some fixtures use virtual modes. Those are modes without a DMX address assigned to them.

## Creating Modes

Let's take a look at how to create modes for a gobo wheel. This gobo wheel can be indexed or rotated.

In the fixture's manual, you will see something similar to this:

16	Gobo Function	Index	0	127
		Rotate	128	255

The sixteenth DMX slot for this fixture is gobo function, which has two ranges for index and rotate.

In the fixture editor, you assign a parameter as gobo wheel mode. Click in the range column to open the range editor. Use **{+}** to add a second range slot. Assign the appropriate range values, and label each range.



**Note:** For this example, the DMX min and max values were entered and then the **Quick Action** of Matched was used so the user values were the same as the DMX ones.



**Note:** It is important to name your ranges. Without labels, only the range values will display when selecting conditions, and the mode buttons in the encoder display and ML controls will be blank.

	DMX Min	DMX Max	User Min	User Max	Label
New					
Insert	Quick Actions...				Quick Labels...
Delete	0	127	0	127	index
Delete	128	255	128	255	rotate
Label	+				
New Mode					
Delete Mode					

Back in the fixture editor, assign a parameter as gobo index/speed. Click in the range column to open the range editor. Press **{New Mode}** to create two modes.

2	Gobo Wheel Mode	Image	8b: 2	0	✓	2 Ranges
3	Gobo Index/Speed	Image	8b: 3	0		2 Modes
New	Mode	DMX Min	DMX Max	User Min	User Max	Label
Insert		Quick Actions...			Quick Labels...	
Delete		0	255	0	100	
		+				
Label		Quick Actions...			Quick Labels...	
New Mode		0	255	0	100	
Delete Mode		+				
Next Mode						
Last Mode						

Click in the mode cell to open the mode selection window.

2	Gobo Wheel Mode	Image	8b: 2	0	✓	2 Ranges
3	Gobo Index/Speed	Image	8b: 3	0		2 Modes
New	Mode	DMX Min	DMX Max	User Min	User Max	Label
Insert		Quick Actions...			Quick Labels...	
		0	255	0	100	
		+				
		Quick Actions...			Quick Labels...	
		255	0	100		
		+				
Previous Mode						
Next Mode						
Last Mode						

- 1: Intens
- 2: Gobo Wheel Mode
  - Gobo Wheel Mode: index (0>127)
  - Gobo Wheel Mode: rotate (128>255)

This window will display all possible conditions that can be applied to your fixture. In this case, there are only two possible.

If a parameter has multiple ranges and is selected as a condition for a mode parameter, all the ranges for that parameter must be used. The fixture editor will allow you to select a condition for a mode and it will automatically place the other range(s) on the next mode.

2	Gobo Wheel Mode	Image	8b: 2	0	✓	2 Ranges
3	Gobo Index/Speed	Image	8b: 3	0		2 Modes
New	Mode	DMX Min	DMX Max	User Min	User Max	Label
Insert		Quick Actions...			Quick Labels...	
Delete	When Gobo Wheel Mode is index	0	127	0	360	D
		+				
Label	When Gobo Wheel Mode is rotate	Quick Actions...			Quick Labels...	
New Mode		128	255	0	80	rpm
Delete Mode		+				
Next Mode						
Last Mode						

Assign the DMX and user values. The range values were used for the DMX values. For index, the user values were set to 0-360 degrees. The **quick label** for degree unit was used so the degree symbol will display in the encoder display. For rotate, the user values were to 0-80 rpm.

Once the modes are created using the index and rotate ranges, the gobo wheel mode parameter will be read only. The range editor for gobo wheel mode will give an advisory saying which mode the ranges are used in. If changes are needed to those ranges, press **{Remove as Mode}** in the range editor. After the changes are made, you will need to reassign the modes.

Remove as Mode Gobo Wheel Mode is a mode parameter for Gobo Index/Speed. These dependencies must be removed to edit this parameter.

	DMX Min	DMX Max	User Min	User Max	Label
	Quick Actions...				Quick Labels...
	0	127	0	127	index
Label	128	255	128	255	rotate
	+				

After patching the new fixture, you will be able to check your modes in the encoder display and ML controls.

There are now buttons for the modes, and for index, the degree symbol is displayed with the user value.

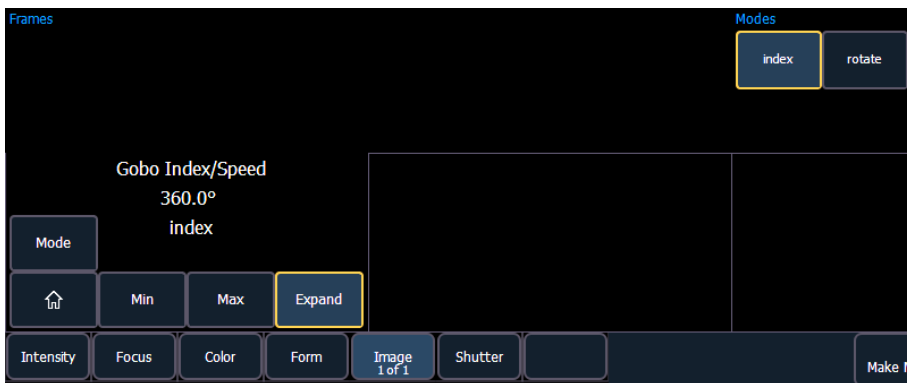

## Lamp Controls

For many devices, their lamp and motor control functions can be controlled remotely using DMX. These will often require use of a timed sequence of DMX levels to control various functions such as striking the lamp, resetting the fixture, and other specific actions.

To define the lamp controls for a device:

1. With the fixture selected, press **{Lamp Ctrl}**. The lamp control display will open.
2. Press **{New}** or **{+}** to add as many lamp control options as needed.
3. Click on the name in the lamp control column to name it.
4. Click in the Steps columns (#, Time, DMX, and Level).
  - **#** - the step number. Each step is tied to a time value, and will execute in order of the step number.
5. Press **{New}** or **{+}** to add as many steps needed for the lamp control.

6. Select the time column to change the timing for each step.
  - **Time (seconds)** - Timing is in seconds. The standard time in the Eos Family library is 12 seconds. Hold can be assigned as a timing value.



**Note:** *It is not recommended that you set the time to **Hold** unless the DMX value should permanently remain at that level. In order to alter a level set with a time of **Hold**, another lamp control to change that DMX value would need to be created.*

7. For each step created, click in the DMX column and press **{New}** or **{+}** to add as many DMX addresses and levels as needed. You may setup as many levels as needed for each step.



**Note:** *While a step is active, the DMX levels for the channel will be held. When a step is no longer active, the levels will be released back to their playback levels.*

- **DMX** - the DMX offset of the parameter you wish to control. DMX can be set to **All Offsets**, which means that all DMX parameters for the fixture will be held at the specified level.
- **Level** - the 0-255 level of the parameter.

### Snap Parameters

Certain parameters may not want to be subjected to cue timing. Those parameters can be set to snap. By default, Eos will snap the parameters listed in the following table:

Beam FX Index/Speed	Effect Library	MSpeed	Shutter
Camera IR Image	Enable	Negative	Shutter Strobe
Clip Directory	File	Object Directory	Strobe Mechanism
Color Effect	File Type	Object File	Sync Source
Color Index	Front/Rear Projection	Output Command	Text
Color Mix	Generator	Page	Texture
Control	Generic Control	Position Blink	Timeline
Copy Mod	Image Movement Speed	Projector Input	Timeline Position
Cue	Internal Media Frame	Relay	Tracking Object
Dimmer Curve	Library	Select	Transition Speed
Edge Blend Profile	Macro	Shape	Transition Time
Effect File	Mode	Shape Library	Transition Type

In the **[About]** channel patch screen, the snap column shows which parameters for that channel are currently set to snap. These parameters can be edited for any profile using the Fixture Editor. See [Fixture Editor \(on page 133\)](#)

**Channel 61**  
ETC Fixtures Revolution RWM/RWM

Address Range: 1-23 Proportion: 100 Curve: GM Exempt: No  
Preheat: None Swap: OFF Invert Pan: OFF Invert Tilt: OFF  
Keywords:  
Notes:

[a]A

Parameter	Address	Home	Snap	DMX
Internal Media F...	6 [1/6]	0	Enabled	0
Edge	7 [1/7]	0		0
Zoom	8 [1/8]	0		0
Position MSpeed	9 [1/9]	0	Enabled	0
Scroller MSpeed	10 [1/10]	0	Enabled	0
Gobo Wheel Sel...	11 [1/11]	0	Enabled	0
Reset	12 [1/12]	0	Enabled	0

Current Values  
Background  
Moves  
Usage  
Patch  
Fixture Notes  
Lamp Controls

## Save Fixture

Unsaved fixture profiles will have a red background in the fixture editor.

Press **{Save Fixture}** to store the new profile, or **{Cancel Edit}** to exit out and not save your changes.



**Note:** If you leave the patch display without saving or using **{Cancel Edit}**, an advisory will display above the command line letting you know that you have unsaved data.

Type	DMX Footprint	Cell	new fixture(1)					
Coloram 2 Scroller *	1		DMX Footprint: 6 Parameter Count: 6					
Dimmer *	1		Create Multicell					
Edit In Progress (ETC - Ti Console TechComm...	3		Remote Dimmer					
Mac 700 Profile Basic	23		#	Parameter	DMX	Home	Snap	Ranges
Mac 2000 Profile 168	24		1	Intens	Intensity	8b: 1	0	0 > 100
new fixture(1) (unsaved edits)	6		2	Pan	Focus	8b: 2	0	0 > 100
Revolution RWM/RWM[Revolution RWM...	23		3	Tilt	Focus	8b: 3	0	0 > 100
Revolution RWM/RWM Copy(1)	23		4	Width	Shutter	8b: 4	0	0 > 100
Sensor Dimmer BB	1		5	Height	Shutter	8b: 5	0	0 > 100
SolaSpot Frame 2000	48		6	Z	Color	8b: 6	255	0 > 100
SolaSpot Pro 2000	43		+					
Studio Spot 575 CMY *	24							
VL3500 Spot *	31							

Save Fixture Cancel Edit

New Insert Delete Remote Dim Lamp Controls Save Fixture Cancel Edit More SK

## Creating Multicell Fixtures

Multicell fixtures can be created by using the fixture editor. You can either create a new fixture, or copy an existing fixture to edit.

To create a new fixture, press **{New}**. A new fixture will be added to the fixture list.

### Naming a New Fixture

Once the new fixture appears in the list, it is recommended that you name the fixture you are about to create.

To name a fixture in the creator list:

1. Use the **[Page]** keys, mouse, or touchscreen to select the new fixture.
2. Press **[Label]** or tap on the new fixture. You can press **[Label]** twice to clear the name. The virtual keyboard will open in the CIA.
3. Enter the desired name for the new fixture on the virtual (or attached alphanumeric) keyboard.
4. Press **[Enter]**. The name will appear in the "Type" column of the fixture list.

## Create Multicell

1. With the new fixture selected, press **{Create Multicell}**.



2. Press **{+}** to add cells. This will open a fixture list display. Only fixtures added to your fixture list will be here.

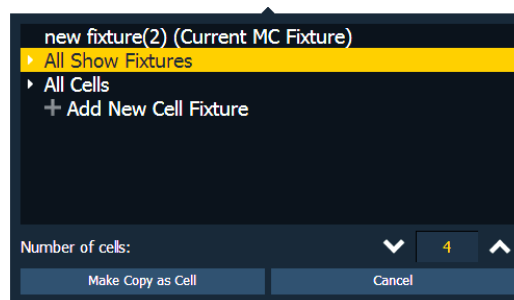

3. Select a fixture, a cell profile from an existing multicell fixture, or create a new cell profile by selecting **+ Add New Cell Profile**.
4. Select the number of cells.
5. Press **{Ok}**. When selecting a fixture, you will need to select **{Make Copy as Cell}** or **{Convert to Cell}**.
  - **{Make Copy as Cell}** - makes a copy of the existing fixture profile and patches the copy as a cell. This will break any references to the original profile.
  - **{Convert to Cell}** - converts to the fixture into a cell. This option will not be available for any library fixture or fixture currently patched in the show file.
6. Make any changes needed to cell numbers, DMX offset, or mastered cells. These settings can be edited later by selecting the **{Edit Multicell}** button. See [Editing Multicell Fixtures \(on page 115\)](#) for more information.
7. Press **{Save Fixture}** to save your changes or **{Cancel Edit}** to remove the changes and exit.



**Note:** If you need to delete a cell profile that has been accidentally selected, select the cell and set the number of cells to 0.

You can now add or edit parameters as needed. See [Editing Multicell Fixtures \(on page 115\)](#) for more information.

## Editing Fixtures

You can view and edit existing fixtures in the Fixture Editor. Edited fixtures will display with an "\*" beside their name.

With the fixture selected, you can change the name by pressing **[Label]** or tapping on the fixture. You can press **[Label]** twice to clear the name. The virtual keyboard will open in the CIA. The fixture's name as it is in the library will still display by the new name.



**Note:** Using *[Update Profile]* will remove any edits made to existing fixtures. Fixtures that have been copied will retain any edits. See [Copying a Fixture \(below\)](#)

---

## Copying a Fixture

It is possible to copy an existing fixture and edit its parameters. In the fixture editor, there is a **{Copy}** button. Pressing **{Copy}** when a library fixture is selected will create a copy of that fixture and will assign it a new name.

## Merging Custom Fixtures into a New Show File

Custom fixtures are saved with your show file and not in the fixture library. If you want to use custom fixtures in a different show file, you will need to use the advanced merge function while in the new show file.

For more information, see [Partial Patch Merging \(on page 94\)](#)

## Importing a Custom Fixture

You can import custom fixtures from an ASCII show file, see [Importing Show Files \(on page 99\)](#)





# Chapter 5

## Setup

---

About Setup .....	150
System .....	150
User .....	159
Device .....	161
Console Status Display .....	166

## About Setup

This section describes the processes involved in changing your system, user, and device settings to meet your preferences.

For more information on settings not found in Setup, see [Overview \(on page 452\)](#).

To enter the setup screen, press **[Displays]> {Setup}** or go to the **Browser>Setup**.

The CIA will repaint to display the setup screen and the softkeys will change to display the various subcategories of setup. Eos defaults to displaying system settings; if you have changed the view to another subcategory, Eos will remember the view you were in when you return to setup.

The setup subcategory softkeys are:

- [System \(below\)](#)
- [User \(on page 159\)](#)
- [Device \(on page 161\)](#)

## System

This setup softkey accesses settings for the entire system. Changing these settings will impact other controllers on the network.

The following buttons are available in System settings:

- [System Settings \(below\)](#)
- [Cue Settings \(on the facing page\)](#)
- [Show Control Setup \(on page 477\)](#)
- [Remotes \(on page 158\)](#)
- [Outputs \(on page 157\)](#)
- [Partitions \(on page 158\)](#)
- [Users \(on page 158\)](#)
- [Recall User Settings \(on page 158\)](#)

## System Settings

This System button gives you access to system settings.

Seven fields will be available to you: **{Num of Channels}**, **{Dim. Dbl. Offset}**, **{Create Virtual HSB}**, **{Home Preset}**, **{Startup Macro}**, **{Shutdown Macro}**, and **{Disconnect Macro}**.

To change the setting for any of these fields, press the field in the CIA to activate it. If the field requires data, enter it from the keypad. If the field is a toggle state, one press of the button will switch the field to its other state.

Changes from this screen are system wide and will impact all consoles and clients connected to the system.

### ***{Num of Channels}***

You may use this field to set the number of channels in your console to the number of channels in your system. Eos supports a maximum of 99,999 channels. The default is 5,000. Only 32,768 channels can exist in the patch, but they can be distributed throughout the entire 99,999 channel count. Enter the number of channels for your system using the keypad. This entry must be confirmed with the **[Enter]** key.



---

**Note:** Every part in a multipart channel will count as an additional channel for the channel count total.

---

### **{Dim. Dbl. Offset}**

This allows you to set the address offset for dimmer doubling. The default for this is 20000, to match the Net2 standard offset, including Sensor dimming software. For dimmer doubling over Local DMX, this value should be set to 256.

### **{Create Virtual HSB}**

**{Create Virtual HSB}** allows you to disable creation of virtual hue and saturation parameters. This option is disabled by default.

When Virtual HSB controls are disabled, the hue and saturation columns will not display in Table view. You will not be able to record just the Hue or Saturation values into a cue, submaster, preset, or palette, and you cannot apply an effect to Hue and Saturation. You will still be able to control Hue and Saturation from the encoders, ML Controls, Color Picker, and the command line.

### **{Home Preset}**

Allows you to specify a preset that will be used as the home level for all non-intensity parameters in the preset, instead of the fixture library defaults. This preset will be applied for all "Go to Cue Out" and home commands. Channels not included in the assigned home preset will continue to home to their library defaults.

### **{System Startup Macro}**

This field allows you to set up a startup macro that will trigger after the console initialization has completed.

### **{System Shutdown Macro}**

This field allows you to set up a disconnect macro that will trigger at power off, not when exiting the application.

### **{Disconnect Macro}**

This field allows you to set up a disconnect macro that will trigger when the primary disconnects from its backup, or when a backup disconnects from the primary.

## **Cue Settings**

Press **{Cue Settings}** to enter this category.

Three fields will be available to you: **{Auto-Mark}**, **{Mark Time}**, and **{Preheat Time}**. You can also set cue default times in this display. **{Auto-Mark}** is not available on Element 2.

To change the setting for any of these fields, press the field in the CIA to activate it. If the field requires data, enter it from the keypad. If the field is a toggle state, one press of the button will switch the field to its other state.

### **{Auto-Mark}**

This toggles the AutoMark settings between enabled/ disabled (see [AutoMark \(on page 216\)](#) for more information). AutoMark is "Disabled" by default.

## ***{Mark Time}***

This field allows you to set the time that mark instructions will use. When **{Mark Time}** is disabled, which is the default, mark instructions will use cue timing unless overridden with discrete timing.

When you enter a mark time in setup, all NPs that mark (either through referenced marking or AutoMark) will use this time. The only way to override setup mark time is to use discrete timing. Clearing the **{Mark Time}** field sets it back to disabled. Select **{Mark Time}** and hit **[Enter]** to disable the default mark time.

## ***{Preheat Time}***

If this option is disabled, the cue's up intensity time will be used when preheating. The default setting is "Disabled".

## ***Cue Default Times***

This area allows you to set the default cue times for the parameter categories of your system. To change a time, touch the parameter category button in the CIA and enter the desired time on the keypad. To set a time for all categories at once, press **{Selection Button} [Thru]**. Pressing **[At]** selects manual times.

The categories for which you may set default times are:

- Intensity Up
- Intensity Down
- Color
- Focus
- Beam

## **Show Control Setup**

This section allows you to adjust settings for MIDI show control, time code (MIDI or SMPTE), analog, and serial functions. For more information on using show control with your system, see [About Eos Family Show Control \(on page 476\)](#)

### ***Device Settings (Local MIDI/SMPTE)***

#### **{MIDI/SMPTE Rx}**

Enables or disables the console's ability to locally receive MIDI or SMPTE. Defaults to "Enabled."

#### **{MIDI Tx}**

Enables or disables the console's ability to locally transmit MIDI. Defaults to "Enabled."

#### **{Time Code ID}**

Sets the console's local Time Code ID.

#### **{USB MIDI/SMPTE}**

Enables or disables local USB connection to supported MIDI or SMPTE devices. This setting must also be enabled for Virtual MIDI devices.

## ***SMPTE***

### **{SMPTE Time Code Rx}**

This button is used to control whether your console can receive SMPTE time code. Choosing “Disabled” will disable all time code lists that have a SMPTE source. The default for this setting is “Enabled”.

### **{Resync Frames}**

This button allows you to configure how many frames need to be synced before time code starts running. Frames can be from 1-30. Default is 2 frames.

## ***MIDI - MSC***

### **{MSC Receive}**

This button toggles the setting for receiving MIDI Show Control from an external source between “Enabled” and “Disabled”. The default setting is “Disabled”.

### **{MSC Transmit}**

This setting, when enabled, allows the console to send MSC messages for actions taken on the console, such as cue actions, macros firing, and submaster bumps. The default setting is “Disabled”.

### **{MSC Rx Device ID}**

This setting allows you to choose the devices from which the console will receive MSC. When set, the console will respond to MSC data from any Net3 gateway that has a matching “ACN MSC Rx ID.” Gateways will send the MIDI data over an ACN connection. When built-in MIDI ports are available, the setting needs to match or at least contain the MSC Rx ID.

#### **Example:**

- {MSC Rx Source ID} [2] [5] [Enter]
- {MSC Rx Source ID} [1] [Thru] [1][0] [Enter]

### **{MSC Tx Device ID}**

This setting allows you to choose the devices which the console will send MSC to.

### **{MIDI Cue List}**

MIDI Cue List specifies the cue list that the console will use to send MSC data. If left blank and MSC Tx is enabled, all cue lists will generate MSC events. Otherwise, only the particular list (or lists) selected will fire MSC events.

## ***MIDI - Network***

### **{MIDI Rx Device ID}**

Also known as a “device ID” this setting configures the MIDI channel for the console to receive MIDI Show Control information. Only MSC data with the same device ID will be received. A device ID can be from 0-126. MSC commands can be sent to ID 127, which is the All Call device ID. While Eos cannot be set to ID 127, it will respond to commands sent to the All Call device ID.

**Example:**

- {MSC Rx Device ID} [5] [0] [Enter]

**{MIDI Rx Device ID}**

Also known as "Device ID" this setting allows you to set the device ID with which your console will transmit MIDI Show Control information. A device ID can be from 0-127. If set to 127, the console will transmit MSC data to all devices (All Call).

**Example:**

- {MSC Rx Device ID} [5] [0] [Enter]

**{MIDI Tx Source ID}**

This setting allows you to choose the devices through which the console will send MIDI data. When set, the console will transmit MSC data from any Net3 gateway that has a matching "ACN MIDI Tx ID." The console will then send the MIDI data over an ACN connection to the gateways. When built-in MIDI ports are available, the setting needs to match or at least contain the MIDI Tx ID.

**Example:**

- {MIDI Tx Source ID} [2][5] [Enter]

***MIDI - MTC*****{MIDI Time Code Rx}**

As above, but for MIDI Time Code instead of SMPTE. Defaults to "Enabled."

***Contacts*****{Analog Inputs}**

This is a master setting for receiving analog inputs from a Net3 I/O Gateway or the built-in I/O port (when available). When disabled, it will no longer trigger any analog input actions on any event lists. Default is "Enabled".

**{Relay Outputs}**

This is a master setting for triggering external relays from a Net3 I/O Gateway or the built-in I/O port (when available). When disabled, will no longer affect any external relays normally triggered from the desk via cues, submasters, or macros. The default is "Enabled".

**Contact Closure (remote trigger connector)**

Allows you to set the Group and Address In values for the remote trigger input on the back of your console. The contact closure only reports on/off even though it is considered an analog input.



**Note:** The contact closures require DC voltage, which is supplied by the console on pins 14 and 15. See the diagram below.

## Relay Out

Allows you to assign the Relay Out Source ID and the Relay Out Address.

### Remote Trigger Connector Pinout

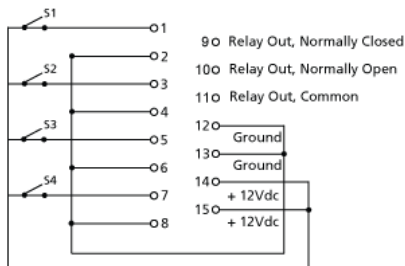
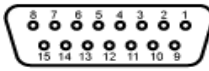

## OSC

### {OSC RX}

Globally enables receiving OSC.

### {OSC RX Port Number}

This setting specifies the UDP port that the console will listen to for OSC receiving strings. Multiple ports can be assigned. A space needs to be used to separate the addresses.



**Note:** ETC recommends using 8000 and 8001 respectively for port numbers. Remember that when setting port numbers on your external device that they should be set to the opposite of what Eos is set. For example, if {OSC TX Port Number} on Eos is set to 8000, then the RX (incoming) port on your external device needs to be set to 8000, and vice versa.

### {OSC Cue Recv String}

Allows the user to specify a different incoming OSC string format for integration with other applications. Use %1 in the string format as cue number and %2 as the cue list number.

### {OSC TX}

Globally enables transmitting OSC.

### {OSC TX Port Number}

This sets the UDP destination port to which the console will send OSC strings. Multiple ports can be assigned. A space needs to be used to separate the addresses.

### **{OSC Cue Send String}**

Allows the user to specify a different outgoing OSC string format for integration with other applications. Use %1 in the string format as cue number and %2 as the cue list number.

### **{OSC TCP Custom Ports}**

Allows the user to specify custom port numbers for multiple OSC TCP connections.

### **{OSC TX IP Address}**

This sets the destination IP address or addresses to which the console will send OSC strings.



**Note:** *Be careful when using a network with a DHCP server. If your external device reboots or is issued a new IP address from a DHCP server, it will no longer receive OSC strings from Eos until you change this setting to match your new IP address at your external device.*

---

### **{OSC USB}**

Allows use of OSC USB devices, such as Lighthack.

### ***String UDP***

#### **{String RX}**

This setting will enable receiving strings on all Serial RX formats.

#### **{String RX Source IDs}**

This setting allows you to choose the Net3 I/O Gateways through which the console will receive serial strings. When set, the console will receive serial from any Net3 I/O Gateway that has a matching "ACN Serial Group ID." The gateway will send serial data over an ACN connection to the console. This only affects serial traffic from I/O gateways and not network UDP messages, ACN strings, or OSC. Serial Group IDs can be from 1-32. Multiple group IDs can be selected by using [Thru] and [+].

#### **{String RX Source Name}**

Allows the user to specify a comma separated list of names for receiving strings, for example, from Paradigm.

#### **{String RX Port}**

This setting specifies the UDP port that the console will listen to for receiving strings. Multiple ports can be assigned. A space needs to be used to separate the addresses.

#### **{String TX}**

This settings will enable sending strings on all Serial TX and OSC formats.

#### **{String TX Source IDs}**

This setting allows you to choose the Net3 I/O Gateways through which the console will transmit serial string data. When set, the console will transmit serial to any Net3 I/O Gateway that has a matching "ACN Serial Group ID." The console will send the serial data over an ACN connection



to the gateways. This only affects serial traffic to I/O gateways and not network UDP messages, ACN strings, or OSC. Serial Group IDs can be from 1-32. Multiple group IDs can be selected by using [Thru] and [+].

### **{String TX Source Name}**

Allows the user to specify a list of specific comma-separated names of devices to send strings to (for example, for use with Paradigm).

### **{String TX Port}**

Setting for the UDP destination port that the console will send strings. Multiple ports can be assigned. A space needs to be used to separate the addresses.

### **{String TX IP Address}**

Sets the destination IP address or ACN devices supporting the ACN String EPI that the console will use to send strings. This can contain either an IP address for UDP string destinations or ACN device names.. A combination of UDP and ACN devices are not supported. Please see [String Interface](#) for more specific configuration information.

### **{String MSC TX}**

When enabled, this setting will cause the console to send serial strings when certain actions happen at the console. See [Sending From User Events](#).

## **Outputs**

This System button gives you access to Outputs settings. These settings are also found in the ECU.



**Note:** *Changes to these settings may require a restart. When required, a warning message indicating a needed restart will display.*

---

## **Local DMX**

The following settings are available:

- **Enable** - enables DMX output from the local DMX ports.
- **Default Output Protocol** - enables DMX as a default output.
- **Output in Client Mode** - allows for output in offline mode for use with a visualization program.
- **Dimmer Doubled Offset** - this offset matches the default offset in CEM+ / CEM3 when configuring your Sensor dimmer rack for dimmer doubling. The default offset is 20,000. Sensor Classic racks should be set to an offset of 256.

The following settings can be edited within the table by clicking on a cell:

- **Address** - sets the starting address for the port.
- **RDM** - enables RDM on the port.
- **Doubled** - enables dimmer doubling on the port.
- **Speed** - sets the speed for the ports. Options are: maximum, fast, medium, and slow. The speed may need to be adjusted for certain devices. The default speed is maximum.



**Note:** *In-cell editing must be enabled to be able to make changes to the table. See [In-Cell Editing \(on page 164\)](#)*

---

## Remotes

The **{Allow Remotes}** button is for allowing Net3 RFR, iRFR, and aRFR connections. The default setting is “Enabled”. For more information see [RFR \(on page 472\)](#).

## Partitions

Pressing the **{Partitions}** button in system setup opens the partition display in the CIA. This display shows any recorded partitions, including the four pre-existing partitions. For more information, see [Using Partitions \(on page 439\)](#).

## Users

In this display, you can set the User ID for the console by selecting the **{User ID}** button and entering a number from the keypad. You can also add or delete users from this display.

For more information on User ID see [About User ID \(on page 444\)](#).

## Recall User Settings

When multiple users are in a system, this option allows you to select a user to recall their settings.

The following settings will be recalled:

- Manual Time
- Sneak Time
- Go to Cue Time
- Back Time
- Assert Time
- Timing Disable Time
- Off Time
- Release Time
- Record Confirm
- Delete Confirm
- Cue Only
- Auto Playback
- Plus %
- Minus %
- Level
- Update Defaults (all)
- Partition
- Highlight
- Lowlight
- Highlight Remdim
- Live Remdim Level
- Preserve Blind
- Encoder Degrees Per Rev
- Encoder Percent Per Rev
- Preserve Native (Patch Setting)
- Gel Match Type (Color Picker Setting)
- Gel Swatch Type (Color Picker Setting)
- Popup Magic Sheet
- Popup Nav Lock

## User

This setup softkey accesses settings for a specific user. Changing these settings does not impact other users on the network.

The following buttons are available in User settings:

- [Record Defaults \(below\)](#)
- [Manual Control \(on the next page\)](#)
- [User Displays \(on page 161\)](#)

### Record Defaults

Press **{Record Defaults}** to enter this category.

Eight fields will be available to you: **{Track}**, **{Record Confirm}**, **{Delete Confirm}**, **{Auto Playback}**, **{Update Mode}**, **{Break Nested}**, **{Update Last Ref}**, and **{Emergency Mark}**.

**Note:** **{Emergency Mark}** is not available on Element 2.

To change the setting for any of these fields, press the button in the CIA to activate it. If the field requires data, enter it from the keypad. If the field is a toggle state, one press of the button will switch the field to its other state.

#### **Track**

This field allows you to switch between tracking and cue only modes (see [Tracking vs. Cue Only \(on page 6\)](#)). The default is "Tracking".

#### **Record Confirm**

This setting allows you to enable/ disable the confirm action when storing over a previously recorded target. The default is "Enabled".

#### **Delete Confirm**

This field allows you to enable/ disable a required confirmation before any delete command is executed. The default is "Enabled".

#### **Auto Playback**

When enabled, this feature automatically plays back cues and submasters as they are stored and releases manual control. For submasters to automatically play back, the slider must be at full. This field is a toggle state between "Enabled" and "Disabled". When auto playback is "Disabled", all manual levels are maintained and cues must be loaded and executed on playbacks. The default is "Enabled".

#### **Update Mode**

This field allows you to select a default update mode (see [Update Dialogue Box \(on page 267\)](#)). The default is "Make Absolute".

#### **Break Nested**

This setting allows you to enable/ disable the update modifier break nested. The default is "Enabled".

#### **Update Last Ref**

This setting allows you to enable/ disable the update modifier update last ref. The default is "Enabled".

## ***Emergency Mark***

**{Emergency Mark}** can be used to automatically set a mark flag if you had not previously done so. If using **{Earliest M}** and no cue with a mark flag has already been set, **{Emergency Mark}** will set a mark flag.

**{Emergency Mark}** can be set to either Earliest or Latest. Latest is the default setting.

- If set to Earliest, **{Emergency Mark}** will set the mark flag on the earliest cue after the cue which fades the intensity out for the selected channel.
- If set to Latest, **{Emergency Mark}** will not set a mark flag. It will instead create a broken mark, which will display an x in the previous cue in the Playback Status Display.

## **Manual Control**

This user setting button gives you access to manual control settings.

### ***Manual Time***

In this section you may change the default times for manual changes to occur in live. Times can be set for each parameter category (Intensity Up, Intensity Down, Focus, Color, and Beam). You may use the **[Thru]** key to enter a value for all categories.

- **{Int Up} [Thru] [9] [Enter]**

The default for each of these is 0 seconds.

### ***Manual Control***

This section allows you to specify the values for certain buttons or settings used in manual control. To change any value, touch the appropriate button in the CIA and use the keypad to enter a new value. Fields are:

- **Level** - This sets the value for the **[Level]** key. Any value between 0-100 may be entered. The default is 80.
- **Plus%** - This sets the level for the **[+%**] key, which will increase the selected channel by the set percentage. You can assign +% to values that have up to five digits. The default is 10%.
- **Minus%** - This sets the level for the **[-%**] key, which will decrease the selected channel by the set percentage. You can assign -% to values that have up to five digits. The default is 10%.
- **Highlight Preset** - This field is used to specify the preset that will be used for any highlight commands.
- **Lowlight Preset** - This field is used to specify the preset that will be used for any lowlight commands.
- **Highlight Rem Dim** - This enables a remainder dim when in highlight mode, thereby temporarily dimming any channel not participating in the High/Low. An intensity level or a preset can be assigned in this field. Channels not in highlight or lowlight that are not included in the preset are not affected.
- **Live RemDim Level** - This allows you to set the level for all remainder dim commands in live. The default is 0. An intensity level or a preset can be assigned in this field.

### ***Default Times***

In this section you may change the default times for sneak commands and the respective feature response times based upon parameter category. The default for these is 5 seconds, except for back time, which uses a default of 1 second. You can assign separate timing values to the Release and Off functions.

You can assign [Cue] as a timing value for the {Go to Cue Time} and {Back Time}. The syntax, {Go to Cue Time} [Cue] [Enter] or {BackTime} [Cue] [Enter] will assign cue as the timing value.

When [Go To Cue] [n] [Enter] or [Back] is used, the fade will happen in the time set in the destination cue.

You can assign a separate time value for [Timing Disable]. When a fader has been set to timing disable mode, cues will use the time set in Setup. The default time is 0.

## User Displays

This user setting button gives you access to the following display settings:

- **{Preserve Blind Cue}** -This enables the desk to display the last selected cue in blind when you return to blind. The default is disabled.
- **{Popup Magic Sheet}** - assigns a magic sheet as a popup magic sheet.
- **{Popup Nav Lock}** - enables or disables the zoom and scroll navigation for popup magic sheets. This option is enabled by default.

See [Popup Magic Sheet \(on page 47\)](#) and [About Magic Sheets \(on page 398\)](#) for more information.

## Device

This setup softkey accesses settings for the specific device. Changing these settings does not impact other controllers on the network.

The following buttons are available in Device settings:

- [Config \(below\)](#)
- [Outputs \(on page 157\)](#)
- [Face Panel \(on the next page\)](#)
- [Fader Wing Config \(on page 163\)](#)
- [Displays \(on page 164\)](#)
- [Trackball Settings \(on page 165\)](#)
- [Brightness Settings \(on page 165\)](#)
- [PDF Settings \(on page 166\)](#)
- [Recall Device Settings \(on page 166\)](#)

## Config

Press {Config} to enter this category.

Two fields will be available to you: {Visible to Remotes} and {Device Name}.

### **{Visible to Remotes}**

{Visible to Remotes} allows your console to be automatically detected by the application. If not used, you will need to manually configure a connection to your console.



**Note:** *If using {Visible to Remotes}, the application will identify the consoles by their name and IP address, so it is useful to know the device names and addresses to ensure that you are connecting to the right one.*

---

## {Device Name}

---



**Note:** Changes to this setting will require a restart. A warning message indicating a needed restart will display.

---

This specifies the name the console will use to identify itself on the network to other devices. Examples might be Booth Desk and Tech Table.

This setting is also available in the ECU.

## Face Panel

The Facepanel settings display is divided up into four areas.

### Encoders

There are two options available: **{Degrees Per Rev}**, which is for the pan & tilt encoders, and **{Percent Per Rev}**, which is for the other encoders. When a pan or tilt encoder is moved one revolution, the parameter will change by as many degrees as defined in Setup. The default is 30. When any other encoder is moved one revolution, the parameter will change by the set percentage of its entire range. The default is 35.

The settings for **{Encoder Degrees Per Rev}** and **{Encoder Percent Per Rev}** are stored with the show file. Starting a new file will reset the two settings to their default values.

---



**Note:** Hold down **[Shift]** while moving the encoder for fine control. Releasing the **[Shift]** key will restore the encoder to its default mode.

---

## Keyboard

There are four options available:

- **{Sounds}** - allows you to enable or disable sounds. When disabled, the volume level controls will not display.
- **{Spacebar [Go]}** - allows you to enable the spacebar on an external keyboard as the hotkey for **[Go]**. By default, it is "Disabled".
- **{Hide Mouse}** - With hide mouse enabled, if the mouse is left idle for 10 seconds, the cursor will go away. Once the mouse is used again, the cursor will return. By default, this is "Disabled".
- **{Use Shift as Eos Shift}** - allows the SHIFT key on an alphanumeric keyboard to be used as the console's **[Shift]** key. If not selected, the Z key on an alphanumeric keyboard will function as the **[Shift]** key.

## Volume Level

You can adjust the frequency and length of the audible signals that your console delivers. Signals are qualified as being either an error, advisory, or click sound. All types of sounds can be adjusted from this setup screen in the CIA.

To adjust a sound, move the virtual slider with your finger (or mouse) on the CIA. To hear the result of your adjustment, press the **{Test}** button respective to the sound type, located beneath the sliders.

## Auto Repeat

This setting allows you to adjust the auto repeat settings (delay and speed) for the facepanel keypad.

## Fader Wing Config



**Note:** This feature is not available on Element 2.

This screen allows you to manually configure the positions of fader wings connected to your console. The console will default to configuring the wings on its own. To manually configure, you must click on the **{Manual Config. Off}** softkey.

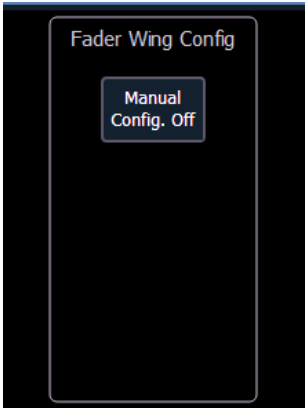

Clicking on the **{Manual Config. Off}** button turns manual configuration on and displays the Fader Wing Configuration screen.

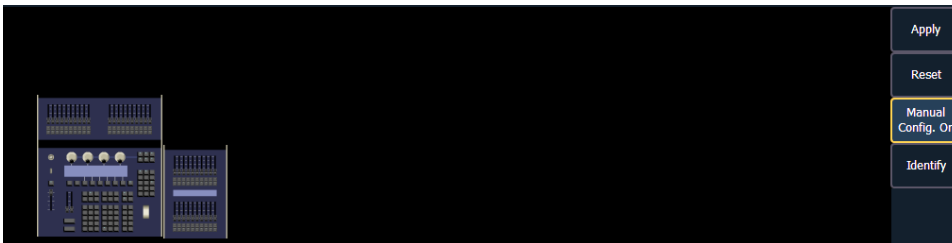

Clicking **{Identify}** will display numbers on each wing's display to aid in configuration. The numbers do not identify the wings as to their actual order. Order is determined from left to right. The left most wing will contain the first faders.

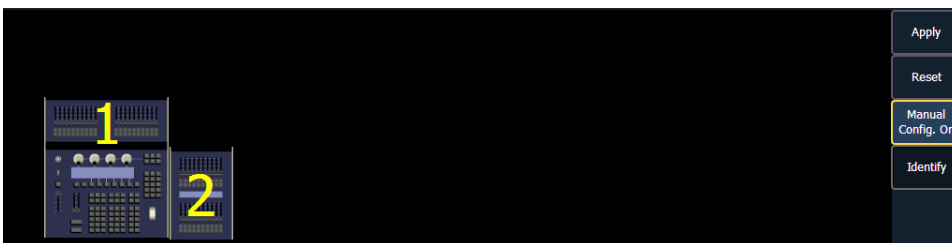

Click and drag the wings to match your physical layout. Click **{Apply}** to save the changes. Clicking **{Reset}** will restore to the last saved configuration. Clicking **{Manual Config. On}** will turn off manual configuration and will require a restart of the application before the console will automatically configure the wings.

## Displays

This device setting button gives you access to the following settings. See [Live and Blind Configuration Menu \(on page 57\)](#) and [Playback Status Display Configuration \(on page 66\)](#) for additional display settings.

### Show Reference Labels

When enabled, referenced record targets (such as presets or palettes) with labels will have their labels displayed rather than their target type and number. This is disabled by default.

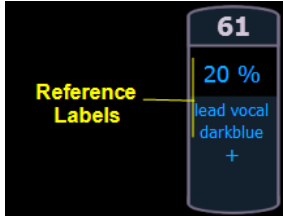

{Show Reference Labels} is a global setting that will affect all displays. For some displays such as live and blind, {Show Reference Labels} can be enabled at the individual tab level by accessing the tab's configuration menu. This will override the setting in Setup.

### In-Cell Editing

When disabled, this setting prevents changes to be made to the cells in the Live/Blind and Playback Status Displays. {In-Cell Editing} is enabled by default.



**Note:** Options in the CIA are not affected by this setting.

### DirSel.Dbl Clk

When enabled, double clicking a direct select button will act as [Recall From] [Record Target] to place the entire contents of that preset, palette, or step-based effect on stage. The default for this setting is "Disabled".

### Display Fader Ribbon

When enabled, the fader ribbon will display. The fader ribbon shows the state of Element's faders. When disabled, the fader ribbon will not display. {Display Fader Ribbon} is enabled by default.

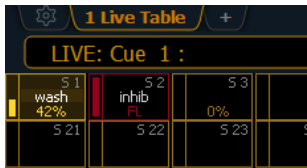

### Display Help Prompts

When enabled, Element displays help prompt above the command line. When disabled, the prompts will not display. {Display Help Prompts} is enabled by default.

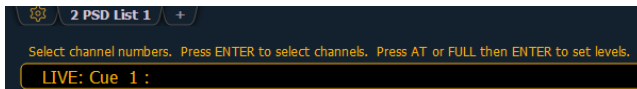



## Trackball Settings

This screen allows you to select various trackball options.

### **Swap Pan/Tilt**

This touchbutton swaps the directions for Pan and Tilt on a trackball. The default for Pan and Tilt is X and Y, respectively. When this button is enabled, Pan and Tilt will be Y and X.

### **Reverse Pan**

This touchbutton reverses the direction of Pan.

### **Reverse Tilt**

This touchbutton reverses the direction of Tilt.

### **Reset**

This button resets all three trackball settings back to their default.

## Brightness Settings



**Note:** This screen on Eos allows you to adjust the brightness and contrast settings for the fader wing LCDs and the light level for desk lamps.

---

This screen on Eos Ti, Gio, and Gio @ 5 allows you to adjust the brightness and contrast settings for the fader wing LCDs, the light level for desk lamps, backlit keyboard, the LCD, and direct select brightness.

This screen on Ion Xe allows you to adjust the brightness and contrast settings for the fader wing LCDs, the light level for desk lamps, backlit keyboard, and direct select brightness.

This screen on Element 2 allows you to adjust the brightness and contrast settings for the light level for desk lamps, backlight on the facepanel, and direct select brightness.

### **Master**

The master can be used to set an overall limit to the brightness of the other brightness settings.

### **Live Master**

The brightness of the LCD touchscreens, Littlites, and backlit keyboard can also be controlled by a live master when outside of the setup display.

By default, the Littlites and backlit keyboard are controlled by the live master. Pressing the **{Live Master}** button under the sliders will either include or exclude that item from being controlled. When the button is highlighted in gray, the item can be controlled by the live master.

The live master is controlled by holding down the **[Displays]** key and rolling the level wheel.

### **Desk Lamp**

Desk lamps, such as Littlites, can be dimmed from within the software application. The **{Desk Lamp}** slider has a range of 0% (dimmiest) to 100% (brightest). The default setting is 0%. The console will set the desk lamp to this setting on startup of the application.

The desk lamps can also be controlled by holding down **[Displays]** and rolling the level wheel if under **{Live Master}** control.

## Backlight

The brightness of the backlit keys on Eos Ti, Gio, Gio @ 5, and Ion Xe are user-definable. The level range is from 0 through 100%, with 50% being the default level. On Element 2, this controls the backlight for the fader position switch.

When the console has been idle for 10 minutes, the backlit keys will fade their intensity down by 10%. Any key press on either the facepanel keyboard, an external keyboard, move of the mouse, or touch of a touchscreen will return the keys to their set intensity level.

## LCD

The brightness level of the LCD touchscreens on Eos Ti and Gio can be adjusted. The range for the brightness level is 5 through 100%, with 100% being the default level.

## Subwing Display

For attached wings, you can adjust the brightness and contrast of the wing's LCD displays. The level range is from 0 through 100%, with 55% being the default level.

## Direct Selects Brightness

Use this slider to adjust the color coding of direct selects, as well as the color swatches of color palette direct selects.

If the slider is set to 0, the color coding for the direct selects is removed, and a yellow outline will display around valid palettes based on your fixture selection.

## PDF Settings

This screen allows you to select the orientation and paper type for PDF files.



## Recall Device Settings

When multiple devices are in a system, this option allows you to select a device to recall their settings.

## Console Status Display

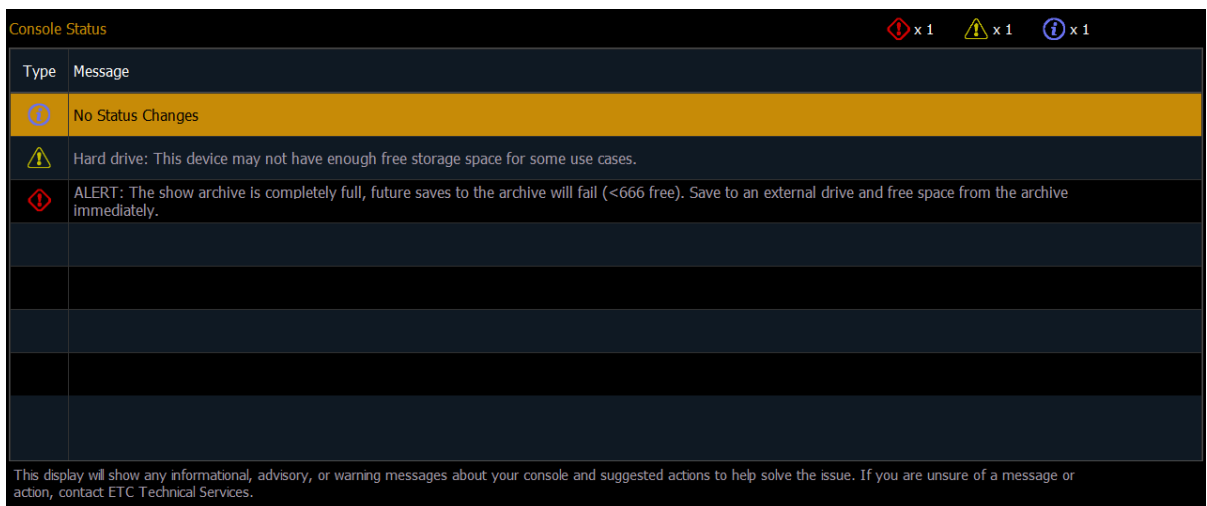

The Console Status Display (CSD) shows informational, advisory, or warning messages about your console. The CSD can be opened via **Browser > Setup**, or through **About > Console Status**.



Type	Message
	No Status Changes
	Hard drive: This device may not have enough free storage space for some use cases.
	ALERT: The show archive is completely full, future saves to the archive will fail (<666 free). Save to an external drive and free space from the archive immediately.

This display will show any informational, advisory, or warning messages about your console and suggested actions to help solve the issue. If you are unsure of a message or action, contact ETC Technical Services.

The Type column displays the category of the message:

Informational		Instructional data that does not impact console functionality.
Advisory		Console operation can continue, but with caution.
Warning		Urgent issues that require immediate attention.

The Message column displays the message details, and any applicable suggested actions to help resolve the issue. The counter in the top-right displays the total quantity of each type of message.

## Possible Status Messages

### *Hard Drives*

- ALERT / Hard Drive / Show Archive
  - This device does not have enough available hard drive space to operate safely.
  - Minimum %2 free space recommended.
  - The show archive is completely full, future saves to the archive will fail.
  - Save to an external drive and free space from the archive as soon as possible.

### *Memory Problems*

- Memory Fragmentation / System Memory
  - Largest Free Block is under %1 MB.
  - RAM usage is at or above %1% (threshold %2%).
  - Application memory usage is at or above %1 (threshold %2), which is close to exhausting addressable memory space.



# Chapter 6

## Basic Manual Control

---

About Basic Manual Control .....	170
Using Channel Faders On Element 2 .....	170
Selecting Channels .....	170
Setting Intensity .....	174
Manual Control of Non-intensity Parameters (NPs) .....	175
Home .....	189
Multiple Intensity Channels .....	190
Multicell Fixtures .....	190
Lamp Controls .....	192
Using [+ %] and [- %] .....	193
Remainder Dim .....	194
Highlight and Lowlight .....	196
Sneak .....	197
Select Keys .....	198
Channel Check .....	200
Address at Level .....	200
Address Check .....	200
Flash .....	200

## About Basic Manual Control

Eos provides a variety of different ways to select and command control channels. This chapter identifies the many basic ways you can select channels and manipulate show data within Eos.

For additional methods, see [About Advanced Manual Control \(on page 294\)](#).

## Using Channel Faders On Element 2

One way to bring up channel levels with Element is using the channel faders. The fader position switch is used to select between channels 1 through 40, channels 41 through 80, or channels 81 through 120. Element will ship with the fader position switch in channels 1 through 40 mode.

With the fader position switch in channels 1 through 40 mode, channel 1 will be controlled by the leftmost fader in the first bank of faders. Channel 40 will be controlled by the rightmost fader in the second bank. When the fader position switch is in channels 41 through 80 mode, channel 41 will be controlled by the leftmost fader in the first bank of faders. Channel 80 will be controlled by the rightmost fader in the second bank.



**Note:** Channel faders will only control the first 120 channels. Channels 121 and above must be controlled via the keypad. See [Selecting Channels \(below\)](#)

---

Raising a channel fader will bring up the corresponding channel's level. This will be reflected on Element's live display. The channel intensity level will appear in red to indicate the level is being set manually. See [Color Indicators \(on page 55\)](#)

Element's fader status display will also show the channel's level. For more information, see [Indicators in the Element Fader Status Display \(on page 80\)](#)

Element's channel faders are LTP or Latest-Takes-Precedence, which means that you can take control of a channel simply by moving the fader to match the current output level. Channel faders, like the keypad and level wheel, can then take levels above or below the current playback level. See [HTP vs. LTP \(on page 9\)](#).

Holding down [Shift] while moving the channel faders, will allow them to move without changing the channel levels. This is helpful when you have used your channel faders to record a cue. This allows you to restore your faders to zero, while leaving the cue values on stage. If you don't do this, the LTP behavior will drive the channels toward zero.

## Selecting Channels

There are multiple ways to select channels including the control keypad, direct selects, and groups.

Selected channels are available for manual control through keypad commands, level wheel, and/or ML controls.

Channels are deselected when any action is taken on the keypad that is unrelated to manual control, such as recording groups and cues, or updating a record target, etc. You can also press [Clear] after a terminated command line to clear the channel selection.



**Note:** When manual channels are used, there will be an advisory that says "Manual Channels" in red in the upper left hand corner of any Live display.

---



**Note:** Selecting channels from the summary or table displays will start a new command line.

---

## Select Channels From the Keypad

The keypad defaults to selecting channels. Channels may be selected on the control keypad using the **[+]** and/or **[-]** and **[Thru]** keys for consecutive or non-consecutive channel selection.

The following examples illustrate various methods of selecting channels from the control keypad:

- **[5] [Enter]** - selects channel 5.
- **[5] [+] [7] [Enter]** - selects non-consecutive channels 5 and 7.
- **[5] [Thru] [9] [Enter]** - selects channels 5 through 9.
- **[2] [Thru] [8] [-] [5] [Enter]** - selects a range of channels 2 through 8, except channel 5.
- **[-] [6] [Enter]** - removes channel 6 from the current selection list.
- **[+] [1] [Enter]** - adds channel 1 to the current list of channels.



**Note:** You may use **[+]** and/or **[-]** multiple times to add or remove multiple channels from the selection. **[Thru]** lists may be entered in ascending or descending order.

---



**Note:** The **[Thru]** command uses the current flexichannel state. Channels not included in the flexichannel mode (except selected channels mode) are not collected in a thru range. **[Thru] [Thru]** can be used to collect all channels in the range, even if they are not in the current flexi mode. See [Using Flexichannel \(on page 59\)](#) for more information.

---

## Modifying a Terminated Channel Selection

It is possible to add or remove channels from a previously terminated command line. You will need to first press **[+]** or **[-]** and then you can add to or remove from your current channel selection. This includes selecting channels from the direct selects, summary view, and Magic Sheets.

## Using Groups as a Channel Collector

**[Group]** can be used as a quick way to collect channels from submasters, cues, palettes, or presets. See [About Groups \(on page 204\)](#) for more information.

The following actions are possible:

- **[Group] [Cue] [1]** - selects all the channels in cue 1.
- **[Group] [Sub] [3]** - selects all the channels in submaster 3.
- **[Group] [Int Palette] [5]** - selects all the channels in intensity palette 5.

## **[Next]** and **[Last]**

The **[Next]** and **[Last]** buttons increment and decrement channel selection. If only one channel is selected, **[Next]** increments the channel selection to the next sequential channel, while **[Last]** decrements the channel selection by one.

### Example:

Select channel 10 then change the selection to channel 11 using the **[Next]** key:

- **[1] [0] [Enter]**

Channel 10 is selected with a gold outline around the entire channel and the channel number is indicated in white.

- **[Next]**

Channel 11 is now selected with a gold outline and white channel number while channel 10 is no longer selected.

When a group of channels is selected, pressing **[Next]** or **[Last]** selects the first or last channel in the channel list.

### Example:

Channels 11 through 20 are selected:

- **[Next]**

Channels 11 through 20 are still the specified channel list but only channel 11 is selected for control. You can now sequentially press **[Next]** or **[Last]** to cycle through the list. Press **[Select Last]** to reselect the entire range.



**Note:** **[Next]** and **[Last]** work with the current flexichannel state. See [Using Flexichannel \(on page 59\)](#)

## Offset

**{Offset}** is a feature used to select a range of channels from a broader channel selection. For the offset feature to function, you must first select a group of channels, then press **{Offset}**.

When **{Offset}** is pressed, a channel distribution display will open with multiple Offset options. For a full list of these options, see [Offset \(on page 205\)](#).

These keys, along with the numeric keys from the keypad are used to create channel offsets. These channel commands can be combined with group record functions.

The following examples illustrate how offset works:

- **[1] [Thru] [10] {Offset} {Even} [Enter]** - selects channels 2, 4, 6, 8, 10.
- **{Channel 1} & {Channel 9} {Offset} {Reverse} [Enter]** - using button modules on the direct selects, this selects channels 1 through 9 in reverse order. (Eos Only)
- **[1] [Thru] [2] [0] {Offset} [3] [Enter]** - from the selected group, this syntax would select channels 1, 4, 7, 10, 13, 16, 19 which is an offset of every third channel from the selection.
- **{Group 5} {Offset} {Random} [Enter]** - selects all channels in Group 5 and places them in random order. This selection may be used only temporarily or it may be recorded to a new Group.
- **[1] [Thru] [2] [0] {Offset} {Even} {Random} [Enter]** - selects all even channels within the range and puts them in random order.
- **{Group 3} {Offset} {Reorder} [Enter]** - reorders the channels in group 3 so they are in numeric order.
- **{Offset} [4] [Enter]** -selects every fourth channel in the current channel selection.
- **[1] [Thru] [2] [4] {Offset} [4] [/] [4] [Enter]** - selects channels 4, 8, 12, 16, 20, and 24. You can select to offset by 2/2, 4/4, 3/3 etc.



- **[1] [Thru] [1][2]{Chan Per Group} [3] {Jump} [1] [Enter]** would create these 3 **subgroups** of 3 channels each: (1,2,3) (5,6,7) (9,10,11). Channels 4, 8, and 12 will be jumped over and will not be in the subgroups.

## Select Channels From the Direct Selects

Direct selects provide one-touch selection of channels, groups, palettes, presets, effects and macros. You can configure an array of channels on direct select that display with paging buttons provided for easy scrolling. See [Using Direct Selects \(on page 68\)](#)

Open a direct select display by select **{DS}** from the Home Screen and then select the **{Channels}** button. When channels are posted to the direct selects, you can select one simply by pressing the channel's touchbutton. The command line will show the appropriate channel and the selected direct select will be outlined in yellow.

House Light 1	House Light 2	House Light 3	House Light 4	5	6	7	8	9	10	Channels △ ▽
11	12	13	14	15	16	17	18	19	20	
21	22	23	24	25	26	27	28	29	30	
31	32	33	34	35	36	37	38	39	40	
41	42	43	44	45	46	47	48	49	50	

Channel selection from the direct selects is an additive process. When a channel is selected, it is added to the current selection set. To select only one channel and deselect all others, double-press the channel touchbutton.

### Example:

- If channels **[1] [Thru] [5]** are selected from the keypad, pressing **{Channel 6}** from the direct selects adds channel 6 to the current channel selection.
- If channels **[1] [Thru] [5]** are selected from the keypad, pressing **{Channel 6} {Channel 6}** deselects channels 1 through 5 and selects channel 6.

The following examples illustrate the various methods of selecting channels using the direct selects:

- **{Channel 1}** - adds channel 1 to the currently selected channels, if not currently selected.
- This is similar to pressing **[+] [1] [Enter]** from the keypad. However if channel 1 were currently selected when you pressed **{Channel 1}**, this would deselect channel 1 from the channel selection.
- **{Channel 5} {Channel 6}** - adds channels 5 and 6 to the current channel selection.
- This is similar to pressing **[+] [5] [+] [6] [Enter]** from the keypad.
- **{Channel 5} {Channel 5}** - selects channel 5 and deselects all other channels.
- This is similar to pressing **[5] [Enter]** on the keypad, when the previous instruction is terminated.

## Button Modules

When using the button module on an Eos console, pressing and holding a channel button while pressing another channel button selects those two channels and all channels in between, similar to using the **[Thru]** command from the keypad.



**Note:** This feature is not supported without use of the button module, and is only available on the Eos console.

---

## Deselecting Channels

Channels are deselected when any action is taken on the keypad that is unrelated to manual control, such as recording groups and cues, or updating a record target, etc. You can also press **[Clear]** after a terminated command line to clear the channel selection.

---



**Note:** **[Select Last]** is a fast way to regain your last channel selection. See [Select Last \(on page 198\)](#)

---

Any manual control action taken while record or update is on the command line will automatically reselect your last channel selection.

## Setting Intensity

Channel intensity may be manually entered from the keypad, set with an intensity palette (if programmed) or set with the level wheel. Pressing **[At]** after channel selection assumes an intensity value will be added to the selected channels. You may also use the **[Full]** button to bring the selected channels to their full intensity or you may use the **[Out]** button to fade the intensity out.

Use the **[Level]**, **[+%**], and **[-%]** keys to affect the intensity value of selected channels. Each of these keys are set at a specific value established in the **Setup** ([Manual Control \(on page 160\)](#)).

- **[Level]** is set by default to 80%.
- **[+%**] and **[-%]** are each set by default value of 10 points.

The following examples illustrate the various methods of setting intensity:

- **[1] [+]** **[3] [At]** **[5] <0>** **[Enter]** - selects channels 1 and 3, and sets an intensity level of 50%.
- **[1] [Thru]** **[5] [-]** **[4] [Full]** **[Enter]** - selects a range of channels 1 through 5, except channel 4, and sets the intensity to full.
- **[1] [Thru]** **[8] [At]** **[+]** **[3] <0>** **[Enter]** - adds 30% to all intensities in the channel selection. If they were at 50, they will now be at 80. If channels 1, 3 and 5, were at 30 and 4 was at 50, they would be 60% and 80% intensity, respectively.
- **[5] [Thru]** **[8] [At]** **[/]** **[3] <0>** **[Enter]** - scales the intensities of the selected channels in the list down 30% of their current values.
- **[1] [Thru]** **[4] [At]** **[/]** **[1] [3] [0]** **[Enter]** - scales the intensities of the selected channels in the list up 30% of their current values. If channels 1 through 4 were at 40% intensity, this would scale them up by 30% to a value of 52.
- **[2] [+]** **[5]** [level wheel] - roll the wheel up for greater intensity or down for less intensity.
- **[1] [Level]** - selects channel 1 and sets it to the level as established in **Setup**.
- **[Group]** **[9] [Out]** - selects all channels in Group 9 and sets the intensity values for those channels to zero.
- **[1] [0] [At]** **[At]** - selects channel 10 and sets an intensity level as established in **Setup**.
- **[1] [Full]** **[Full]** - selects channel 1 and sets it to full and self terminates the command line.
- **[1] [At]** **[/]** **[/]** **[2][3][9]** **[Enter]** - puts channel 1 at DMX value 239.

### Example:

- [1] [Thru] [5] [Full] [Enter]

The selected channels are highlighted in gold, with white channel text and red intensity values (indicating manual data). You may continue to modify channels 1 through 5 since they are still selected and displayed on the command line.

- [-%] [-%]

This command would reduce the intensity of channels 1 through 5 by 20%. This command is self-terminating.

- [At] [7] [5] [Enter]

You can continue manipulating the selected channels so long as the channels are selected and displayed on the command line.

### Level Wheel

You may set intensity for selected channels or addresses using the level wheel. Rolling the level wheel upwards increases intensity. Rolling it downwards (towards you) decreases it.

## Manual Control of Non-intensity Parameters (NPs)

Non-intensity parameters can be set with a variety of controls including the control keypad, buttons on the central information area (CIA) and the encoders.

### Using the Parameter Display

The parameter display in the CIA is populated with only those parameters that are found in the patched devices. As channels are selected, the parameter display will change to show only parameters relevant to the selected channels.

The parameters are divided into the following categories: Intensity, Focus, Color and Beam. Each parameter category is represented with buttons in the parameter tiles. These buttons allow you to select the entire collection of all parameters within that category. You can also select a single parameter from a category using that parameter's button in the parameter display.

Beam has three subcategories which correspond to the way the encoders are mapped. They are **{Form}**, **{Image}**, and **{Shutter}**. These subcategories are represented with buttons in the CIA. Pressing these buttons allows you to select all parameters within those subcategories.

AllNPs		△	△	△	△	
All Speed		Scroller	Shutter Strobe	Gobo Wheel Mode	Thrust A	
Filters		Yellow	Zoom	Gobo Select	Angle A	
△	Position MSpeed	Magenta	Edge	Gobo Mode	Thrust C	
Intensity MSpeed	Tilt	Indigo	Iris	Gobo Ind/Spd	Angle C	
Intens	Pan	Cyan	Beam			
Intensity	Focus	Color	Form	Image	Shutter	

Within the CIA, in the upper left corner, notice the **{All NPs}** button. When pressed, this collects all non-intensity parameters for further editing.

Some examples of using parameter touchbuttons are:

- [1] {Iris} [5] [Enter] - Places the iris parameter of channel 1 at 50%.
- [Group] [4] {Zoom} {Edge} [Out] [Enter] - Sends any zoom and edge values for all fixtures in group 4 to their home value.
- [1] [Thru] [3] {All Speed} [At] [2][5][Enter] - Sets all the available speed parameters for channels 1 through 3 to 25.

## Setting Parameters with the Keypad

When the CIA is placed in parameter mode, all parameters of selected channels may be given numeric values through the keypad.

When no channels are selected, the CIA shows all of the parameters that are available in the lighting system. When channels are selected, the CIA condenses to show only the parameters that are appropriate to the selection set. If channels are selected that have different device types, such as spot and wash lights, the CIA will show all of the available parameters.

The following examples illustrate how to set parameter values with the keypad:

- [5] {Iris} [5] {Zoom} [6] [5] {Edge} [5] [Enter] - sets channel 5 to an iris value of 50%, a zoom value of 65%, and an edge value of 50%.



**Note:** Pressing [Shift] & [Encoder Paging Key] will place the associated parameter onto the command line for numeric entry

---

Using [At] [/] [/] will place the direct DMX value on the command line. For example, [1] [At] [/] [/] [2][3][9] [Enter] would put channel 1 at DMX value 239.

You can also set a channel's parameter levels with the DMX value by using [/]/[/].

- [1] {Pan} [/]/[/] [2][5] [Enter]

You can add or subtract from the DMX value by using [+] or [-].

- [1] {Pan} [/]/[/] [+] [5] [Enter]
- [1] {Pan} [/]/[/] [-] [7][5] [Enter]

## Adjusting Parameters Using + and -

[+] and [-] can be used to adjust parameters from the command line. When using [-], you will need to preface the command with [+] if you want to remove from the current value.

### Example:

- [Channel List] {Pan} [1][0] - sets to 10 degrees.
- [Channel List] {Pan} [+] [1][0] - adds 10 degrees.
- [Channel List] {Pan} [-] [1][0] - sets to -10 degrees.
- [Channel List] {Pan} [+] [-] [1][0] - removes 10 degrees.

## Setting Non-intensity Parameters with the Encoders

For more information about the encoders, see [Encoders \(on page 73\)](#).

Encoders provide a quick method to adjust current values for non-intensity parameters.

On Eos Ti and Eos, the bottom two encoders always control pan and tilt functions. The four vertical encoders are pageable using the encoder page buttons near the encoder LCD. On Eos, the five encoder page buttons are: **[Custom]**, **[Color]**, **[Shutter]**, **[Image]**, and **[Form]**. On Eos Ti, the six encoder page buttons are: **[Custom]**, **[Intensity]**, **[Color]**, **[Shutter]**, **[Image]**, and **[Form]**.

On Gio, Gio @ 5, and Ion Xe, the four horizontal encoders are pageable using the encoder page buttons directing under the encoders. The six encoder page buttons are: **[Intensity]**, **[Focus]**, **[Color]**, **[Shutter]**, **[Image]**, and **[Form]**.

Form, Image and Shutter are subcategories within the broader parameter category of Beam.

- **Custom** - includes intensity and intensity MSpeed.
- **Color** - includes all color mixing controls (CMY, RGB, HS), as well as scrollers, color wheels, and color effects.
- **Form**- includes parameters that affect the quality or size of the light output, such as edge, zoom, iris, IMF, frost, etc.
- **Image** - includes anything that drops into the gate, such as gobos, effects wheels, etc.
- **Shutter** - includes all of the framing devices for the luminaire.



**Note:** Pressing **[Shift]** & **[Encoder Page Key]** will post that parameter to the command line. For example, pressing **[Shift]** & **[Color]** would place Color on the command line.

---

## Encoder Display

On Eos and Eos Ti, the encoder display LCD to the left of the encoders indicates the parameters they control and provides additional information about the current status of those parameters. For more information, see [Encoder Display on Eos and Eos Ti \(on page 74\)](#)

On Gio, Gio @ 5, and Ion Xe, the **mini encoder display** indicates the parameters the encoders control and provides additional information about the current status of those parameters. To see additional encoder information, use the **[Encoder Display]** button to open the encoder display. For more information, see [Encoder Controls Display \(on page 75\)](#)

On Element 2, you can access encoder control by using the ML controls display. See [Moving Light Controls \(on page 77\)](#) for more information.



**Note:** For ETCnomad, RPU, and RVI, the encoder display can be accessed by using **CTRL + ALT + \** on an alphanumeric keyboard. **ALT + ,** can be used to change encoder pages.

---

Encoder pages populate with parameters relevant to fixtures in the show patch. When you access a parameter page, controls that are not available for selected channels are suppressed.



**Note:** Flexi encoders is used to suppress parameters not applicable to the selected channels. This is used by default for the encoder display. See [Flexi Encoders \(on page 77\)](#)

---

Each encoder has an associated control section that provides visual indication of:

- the parameter it controls.
- the current setting (value) of the parameter.
- and the current mode if the encoder controls more than one function.

## Coarse/ Fine

Allows for control of “coarse” (8 bit) or “fine” (16 bit) control. Default is coarse control. You may toggle between the two by pressing **[Shift]** while moving the encoder.

- **Coarse** - provides larger changes for non-segmented parameters and advances/decrements full frames for segmented parameters. The encoder is clutched in this mode, meaning you will feel each frame change distinctly.
- **Fine** - provides unlimited, high granularity control. When used in this mode the encoder is not clutched, allowing you smooth and detailed control.

## Encoder paging

The number of encoder pages for each category will display.

For Eos and Eos Ti, they are displayed in blue at the top of the LCD display.

For Gio, Gio @ 5, and Ion Xe, they are displayed at the bottom of the parameter category softkeys.

You can go directly to the page required by pressing the encoder page button and a page number. For example:

- **[Form] & [3]** - this will take you to the third page of the form category.

Information in the encoder display is only as accurate as the patch information for that channel. For example, when you are working with color scrollers, the standard manufacturer color frames will be displayed for scroller controls unless you have created a custom scroll for the selected channel in patch using the Scroll Editor.

When you have created a new scroll or wheel in patch for any channel and that channel is selected, that information will be displayed in the associated encoder display. See [Using the Editor \(on page 117\)](#)

When you access a parameter page, the encoders will automatically load and display the first page that has a valid parameter for the selected channels.

## Encoder Softkeys

A series of buttons are included in each of the four encoders sections of the display including **{Home}**, **{Last}**, and **{Next}** or **{Min}** and **{Max}**, and depending on the type of parameter, a **{Mode}**, **{Expand}**, or **{Calibrate}** button.



**Note:** To access these softkeys at any time, press down on an encoder.

---

## Home

Each parameter has an associated **{Home}** key in the encoder LCD. This accesses any parameter and returns it to its default position. Additionally, the control keypad has a **[Home]** key located below **[Sneak]**. See [Home \(on page 189\)](#) for more information.

## Min and Max

**{Min}** and **{Max}** are displayed when the parameter is linear, such as a shutter. Use these keys to set a minimum and a maximum setting for a parameter.

## Next and Last

**{Next}** and **{Last}** are displayed when the parameter is segmented such as a fixed gobo or color wheel or a color scroller. Use these keys to increment or decrement in full frames.

## Mode

The **{Mode}** key is provided to select different modes for the encoder wheel such as rotate, index, or special effects.

- When more than two modes are available, the **{Mode}** key can be pressed repeatedly, advancing through the various modes. Each mode will display beneath the current parameter setting.
- When only two modes are available, the alternate mode is indicated instead of a **{Mode}** key. Toggling that button switches the encoder wheel to the alternate mode.

## Expand

Some parameters will have an **{Expand}** button, which indicates that this parameter has “Expanded” functions. When that button is pressed, the display repaints to display all the media settings available for the specific wheel.

## Flip

The **{Flip}** button, as displayed in the Pan/Tilt section of the encoder LCD, is used to flip the unit into its exact same position, but from the other direction. Depending on the current values of pan and tilt, there may be multiple flips.

This allows you to correctly focus a fixture that may be at the end of its pan or tilt range or to correct a fade that may be moving in an undesired direction.

The following example illustrates the use of **{Flip}**:

- [channel list] **{Flip}**

## Trackball On/Off

The **{Trackball On/Off}**, as displayed in the Pan/Tilt section of the encoder LCD, is used to give pan and tilt functionality to a mouse or trackball device. When this function is turned on, above the CIA will be a message saying “Cursor as Pan/Tilt”.

## Form Control

Form (a subcategory of Beam) collects the parameters that affect the quality of the beam, including the iris, edge, frost, etc. ‘Shutter’ and ‘Image’ are the other two subcategories of Beam

When the form encoder page button is selected, the LED will illuminate and the encoders automatically populate with the “Form” parameters as specified in the show patch. If there are more parameters in the show patch than will fit on the first page of the encoders, press the **[Form]** button again to page through the remaining parameters in the category or press **[Form]** and a page number to jump to a specific page.

The form parameters may include:

- **Edge** - controls the hard/soft qualities of a spot luminaire. While some fixtures may call this parameter “focus”, it is always represented as “edge” in Eos, to avoid confusion with “Focus” which refers to pan and tilt data. These values are set to the system default value for the selected luminaire, but may be modified as required on a per fixture basis

- **Iris, Zoom, Strobe and IMF**- each parameter has in/out, narrow/wide, or fast/slow settings. Iris and Zoom also have programmable limits, called in/out and narrow/wide respectively. The strobe mode setting varies based on the fixture type.

## Image Control

Image is the collection of parameters that affect the contents of the beam (gobo, prism, effects wheel, etc.).

## Shutter Control

Pressing the [Shutter] button displays shutter controls, if there are any fixtures with framing devices patched.



**Note:** For *Ion*, *ETCnomad*, *RPU*, and *RVI*, the encoder display can be accessed by using **CTRL + ALT + \** on an alphanumeric keyboard. **ALT +,** can be used to change encoder pages.

## Shutter Graphic

Tap or click on the shutter graphic to open up the shutter controls window.

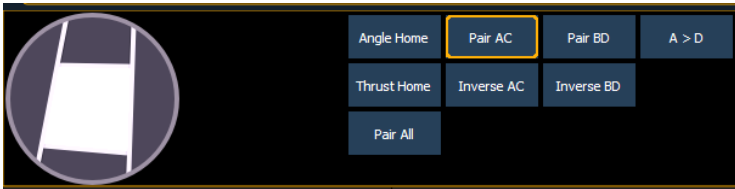

The shutter controls window allows you to move individual shutters by holding down one of the letters inside of the shutter graphic. To rotate the shutters, use the **<A>**, **<B>**, **<C>**, or **<D>** buttons around the outside of the shutter graphic.

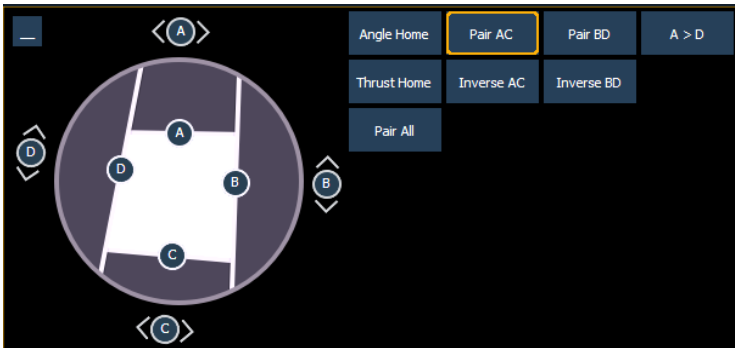

## Encoder Buttons



**Note:** The encoder buttons are used with the encoders for shutter control. These buttons do not work with the shutter graphic control.

The following buttons are available for shutter control:

- **Angle Home**- sets the angle of all of the shutters to their home position.
- **Thrust Home**- sets the thrust (how far in or out of the beam the shutter travels) of all of the shutters to their home position.



- **Pair AC** - pairs the A and C shutters together so they move together.
- **Pair BD**- pairs the B and D shutters together so they move together.
- **Pair All**- pairs all of the shutters so they move together.
- **Inverse AC** - pairs the A and C shutters so they move in the opposite directions from each other.
- **Inverse BD** - pairs the B and D shutters so they move in the opposite directions from each other.
- **A>D** - sets the encoders to use the custom encoder pages for the shutters. Thrust for all of the shutters is on one page, Angle for all is on another page.

## Color Control

Depending upon the specific device, color can be established manually with the encoders using:

- CMY color-mixing
- Hue and saturation color mixing
- RGB color-mixing
- Selection from a color wheel or scroller

You may also specify color by using the color picker. See [Using the Color Picker \(on the next page\)](#) for more information. It is also possible to set non-intensity parameter data with direct entry using the control keypad and using the parameters on the CIA.

- [1] [At] [4] <0> {Cyan} [5] [5] [Enter]

The first page of the color encoder will provide

The first page of the color encoder will provide some scroller control, such as frame selection, on the top encoder. The next three encoders will control HS, CMY, or RGB color mixing. There will be buttons on the first page for switching between HS, CMY, and RGB. The HS controls will include buttons for {Home}, {Min}, and {Max}. The CMY and RGB controls include buttons for {Home} and {Max} for each of the parameters. No {Min} button will be displayed.



**Note:** Color scroller data will display on the encoders and displays as frame numbers, F1, which would be frame 1, F2 for frame 2, etc. F1.5 is halfway between 1 and 2. F2+ will display if the frame is less than 2.5 and F2- if the frame is greater than 1.5. After the frame number, the gel number will also be displayed. This is also true for color and gobo wheels.



**Note:** Frame numbers can be used from the command line. [2]{Scroller}[5][Enter] will send channel 2's scroller to frame 5. Frames can also be selected by using the DMX value for that frame. Pressing [1] twice will post DMX to the command line. [3]{Scroller} [1][1][2][5][5] [Enter] will send channel 3's scroller to the frame with the DMX value of 255.



**Note:** Dual scroller fixtures are addressed as 0-100% instead of by frame numbers. You may need to update your fixture before this feature will work. See [Update Profile \(on page 133\)](#)

---

## Custom Control

Pressing the [Custom] button displays intensity controls.

Intensity parameters may include:

- **Intens** - controls intensity for a single intensity channel or master intensity for a multiple intensity channel.

- **Intens 1-4** - controls the various intensities of a multiple intensity channel.
- **Intensity MSpeed**

Press the [Custom] button again to access the additional intensity controls, available to the specific channel.

## Using the Color Picker

The color picker can be opened from the [Workspace Layout Menu \(on page 42\)](#) or by using [Tab] [2][7].

With the color picker open, you have the choice between six different [Color Spaces](#), a [Gel Picker](#), [Color Path](#), [Tinting Tools](#), and [Spectrum Tools](#).

These options are found by right clicking on Color Picker Tab.



## Color Spaces

There are six color spaces that you can choose to work in. All of these spaces are connected. So it doesn't matter which space you wish to work in, the console will translate the information to work with your fixtures.

When the color picker is first opened, the CIE xy color space and the gel picker will open by default. You can select other color spaces and tools by clicking on the display configuration tool (the gear icon) in the upper left corner of the color picker display.



**Note:** Multiple color picker tabs with different color spaces can be opened at the same time. Multiple color spaces can be opened on the same tab.

---

The available color spaces are:

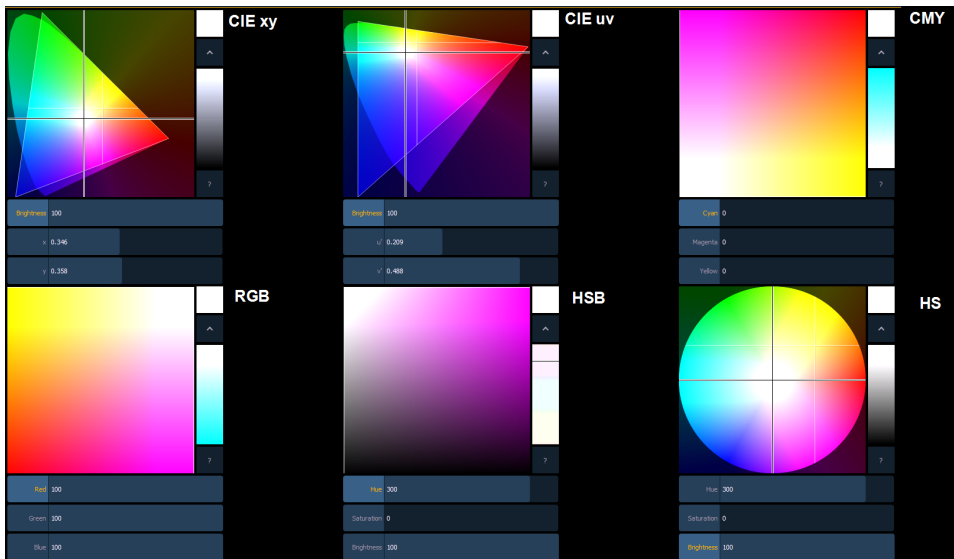

**Note:** When a fixture is in HS mode, the brightness control is not provided. Intensity controls the brightness.

For the CIE xy (CIE 1931) and CIE uv (CIE 1976), the triangle represents the RGB space as defined by the PLASA standard E1.54. Fixtures that comply to that standard can achieve any color within the triangle. The cone represents the color spectrum that we can see.

## Controls

Each color space has three virtual encoders, a vertical encoder, a {?} button, and a {^} button.

The encoders will change based on the color space selected. Double tapping in a virtual encoder will cause it to jump to the location of your finger. Pressing and holding will cause the encoder to fade toward your finger.

Tapping anywhere in the color space will cause the crosshair to move to that location. Press and hold, then move your finger to fade the crosshair toward that location.

The {^} button will create the brightest version of the selected color. Press the {?} button to display labels on all of the controls.

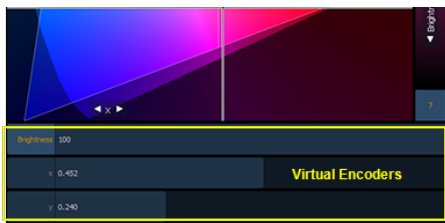

For the RGB and CMY color spaces, you can change which color control is on the vertical encoder. Touch the label of the virtual encoder to change which color control is located on the vertical encoder. In the following graphics, Red is on the vertical encoder in the first one and green is on the vertical encoder in the second one. This is also indicated by the highlighted encoder name.

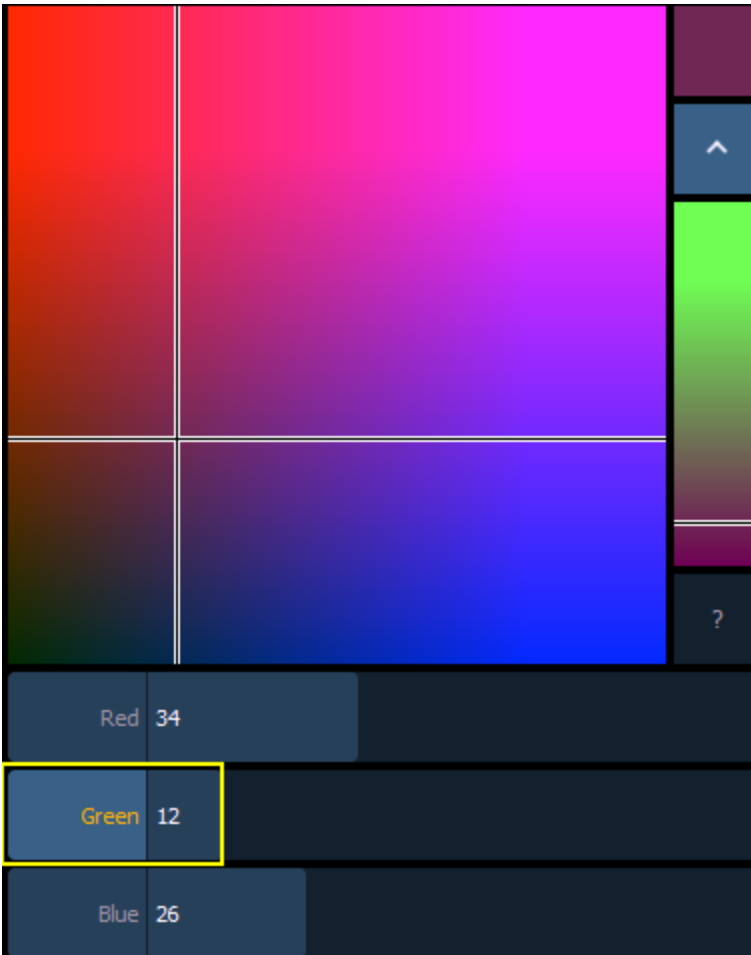
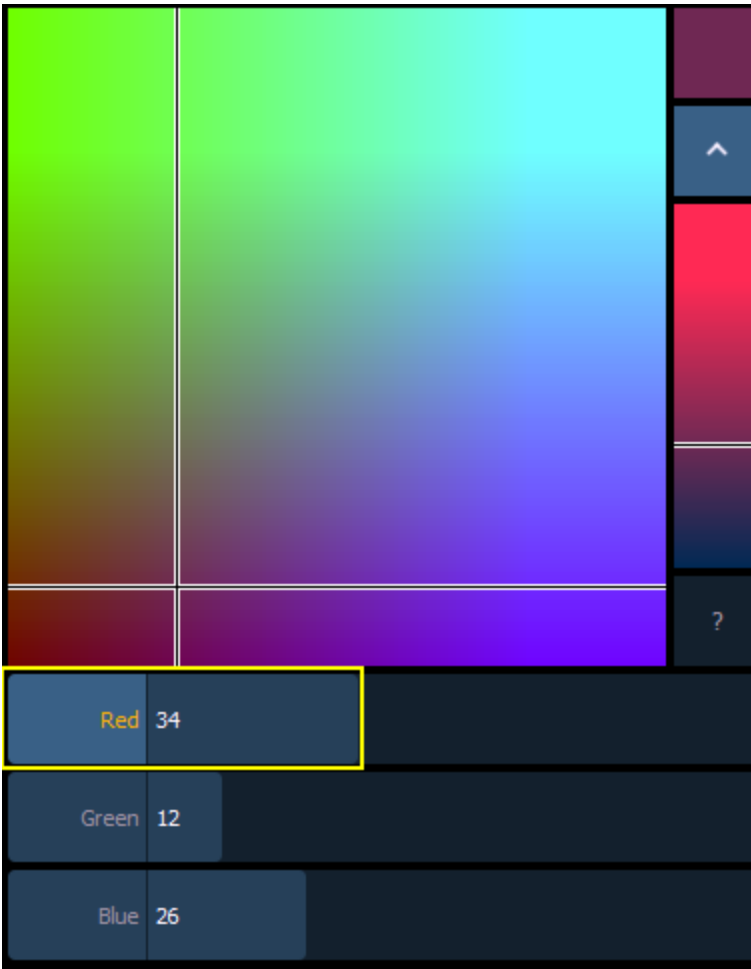

For the HS Wheel and HSB color spaces, the vertical encoder is always brightness.

## Gel Picker

When the gel picker is opened up with a color space, dots will display on the color space. These dots represent the gels in the currently selected gel book. Hovering over a dot with a mouse will display the gel's name and a color swatch.

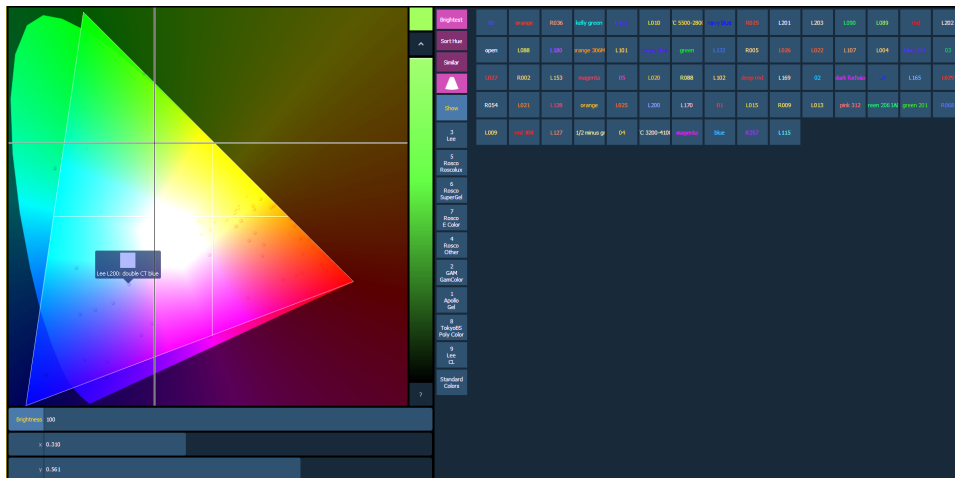

The following buttons are also available:

- **{Brightest}** - determines the color match used. This is helpful when working with fixtures that have more than three color components, such as RGBA, RGBWm or ETC's fixtures. Pressing **{Brightest}** or **{Shift} +a** gel from the picker will cycle through the three modes.
  - **{Brightest}** - matches to the brightest match of that chromaticity.
  - **{Spectral}** - matches to the best spectral match chromaticity. However, this mode can remove a lot of the intensity. This is based off of a 575w long life Source Four®.
  - **{Hybrid}** - halfway between the brightest and the best spectral match. In the channel display, a single dot shows best spectral match, 2 dots indicates hybrid, and no dot shows brightest.



- **{Sort Hue}** - takes the selected gel library and sorts it by hue instead of by gel number.
- **{Similar}** - will show gels that are in the same selected area of the color picker. Only gels in the same selected gel book will display. You can switch to another gel book though to discover gels in that area.
- **{Show Gels as Gel Against White Background}** displays the raw gel color as it would look against a white background. This option toggles with **{Show Gels as Gel + Lamp Output}**.
- **{Show Gels as Gel + Lamp Output}** displays the gel swatch color as if it was being used with a tungsten lamp.
- **{Show}** - displays all of the static gels in the show file. This populates from Patch.
- **{Standard Colors}** - shows a range of White Point from 2700K to 6500K. Also shown are colors located around the triangle and variations of those colors at 25% increments.

Brightest	2700 K	2800 K	2900 K	3000 K	3100 K	3200 K	3300 K	3400 K	3500 K	3600 K	3700 K	3800 K	3900 K	4000 K	4100 K
Sort Hue	4200 K	4300 K	4400 K	4500 K	4600 K	4700 K	4800 K	4900 K	5000 K	5100 K	5200 K	5300 K	5400 K	5500 K	5600 K
Similar	5700 K	5800 K	5900 K	6000 K	6100 K	6200 K	6300 K	6400 K	6500 K	White	Red	Red 75%	Red 50%	Red 25%	Orange
Show	Orange 75%	Orange 50%	Orange 25%	Yellow	Yellow 75%	Yellow 50%	Yellow 25%	Lime	Lime 75%	Lime 50%	Lime 25%	Green	Green 75%	Green 50%	Green 25%
3 Lec	Mint	Mint 75%	Mint 50%	Mint 25%	Cyan	Cyan 75%	Cyan 50%	Cyan 25%	Azure	Azure 75%	Azure 50%	Azure 25%	Blue	Blue 75%	Blue 50%
5 Rosco RoscoGel	Blue 25%	Purple	Purple 75%	Purple 50%	Purple 25%	Magenta	Magenta 75%	Magenta 50%	Magenta 25%	Pink	Pink 75%	Pink 50%	Pink 25%		
6 Rosco SuperGel															
7 Rosco E Color															
4 Rosco Other															
2 GAM GamColor															
1 Apollo Gel															
8 Tokyo85 Poly Color															
9 Lee CL															
Standard Colors															

## How the Gel Picker Affects Scroller and Color Wheel

When possible the Gel Picker will select the closest gel as defined in a scroller or color wheel.



**Note:** Some devices contain manufacturer specified gel mixes, and will only allow selection from the Gel Picker of the exact gels in their list.

The channel display will show the frame number and the corresponding label that is defined for that frame.

## Tinting Tools

The Tinting Tools option is found by right clicking on the Color Picker tab ([Using the Color Picker \(on page 182\)](#)).

Tint allows you to easily adjust color regardless of the color space that you're working in.

You can increase or decrease the saturation and brightness. You can make a color warmer or cooler, and you can add or remove colors.

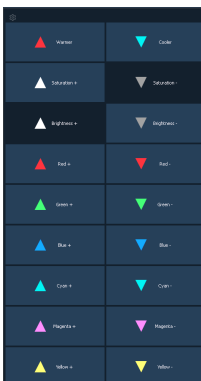

## Color Path



**Note:** Color path is only applicable for additive mixing systems.

Color Path is a option for controlling color fades between cues. By default, color fades happen in the native space of the fixture. If you want a fade that resembles a fade in a different color space, you can do that using color paths. There are eight preprogrammed color paths, and you can also record your own . Up to 1000 color paths are supported.

To open the color path display, click on the gear icon in the color picker display and select Fade. To open the color path list display, press **[Path] [Path]**, by pressing the **{Color Path}** icon in the home screen, use **[Tab] [3][3]**, or from the CIA by going to **Browser > Record Target List > Color Path**.

Color paths are selected either by clicking on the drop down above the color path or by using **[Path] [n]**.







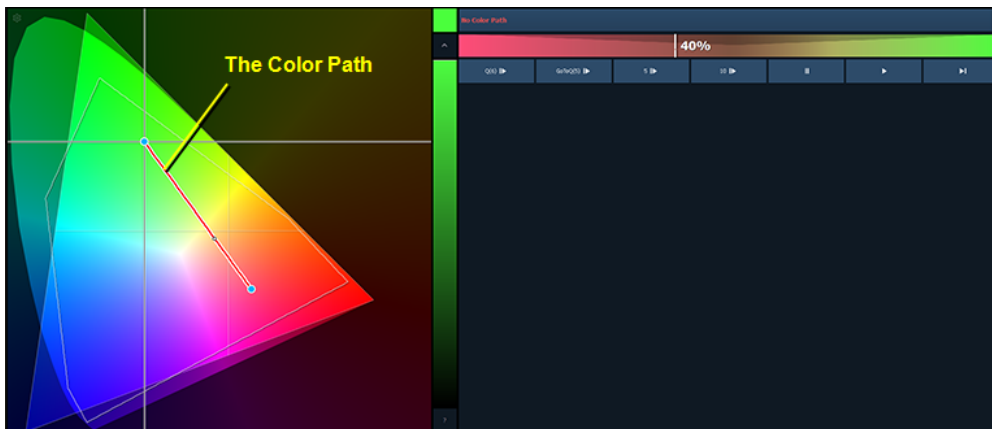

**Note:** Channels involved in the fade have to be selected before you can choose or modify a color path.

The color path display has a drop down list of the available paths, a color path preview bar, and control buttons. An indication line will display on the color space to show the color fade.



Available control buttons are:

-  - replays the color fade using the cue time.
-  - replays the color fade using the Go to Cue time from Setup.
-  - replays the color fade in five seconds.
-  - replays the color fade in ten seconds.
-  - pauses the color fade.

-  - plays / resumes the color fade.
-  - skips to the end of the color fade.

You can also click on the color path preview bar to scrub to any point along the fade.

Additional controls may be available based on the color path selected. For example, Color Path 7 has additional controls for Hue, Saturation, and Brightness. You can move those controls to adjust the fade, and you'll see a representation of those changes in both the color path preview bar and in the color space.

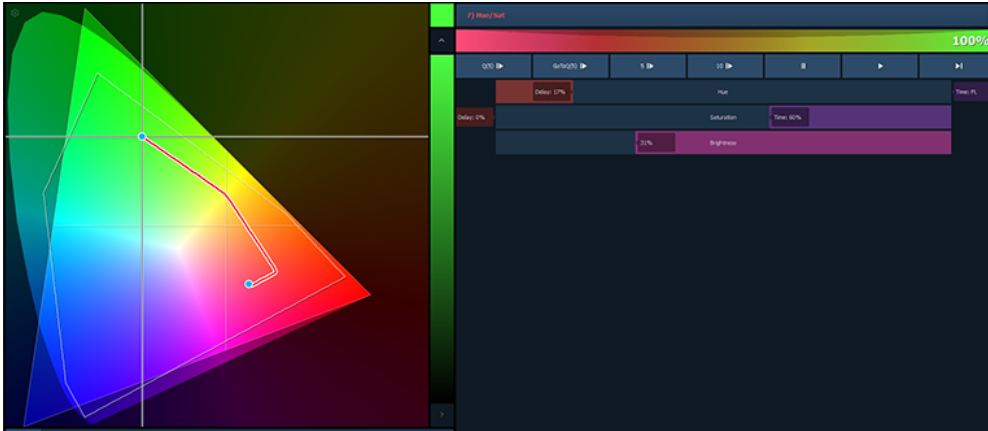

Changes can be stored in the destination cue as absolute data by using **[Update]** or **[Record]**. When there's a change to the color path information, a red c will display next to the channel number and the color path's name will display in red in the color path display. When that data



has been saved, a blue c will display. The color path's name will also display in blue in the color path display.

You can save changes to a new color path by using **[Record] [Path] [n]**. That data will then be referenced, and any changes made to that path will be used anytime that path is used. Press **[Shift] & [Path]** to see the values behind the referenced data.



**Note:** If multiple channels are selected that have different color paths assigned to them, a + will display by the color path name in the color path preview bar.

See [\[About\] Color Path \(on page 375\)](#) and [{Attribute} Display and Settings \(on page 124\)](#) for more information.

## Spectrum Tools

The Spectrum option is found by clicking on the display configuration tool (the gear icon) in the bottom left corner of the display tab bar.

This option displays all the color parameters across the color spectrum, and allows for individual control of each parameter. Press a color point to move it.

This display is a good visual of what the fixture is outputting.



The following screenshots show a 7 color fixture. This display will change based on the type of fixture being used.



**Note:** The gray line shows the composite color of the fixture. If multiple fixtures are selected, the gray line represents the first channel selected.

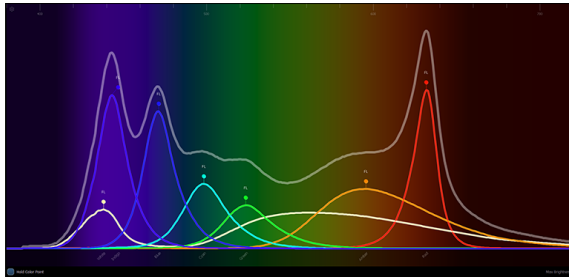

With the *Gel Picker* open and a gel selected, a dotted line will appear in the Spectrum display. That line represents the selected gel.

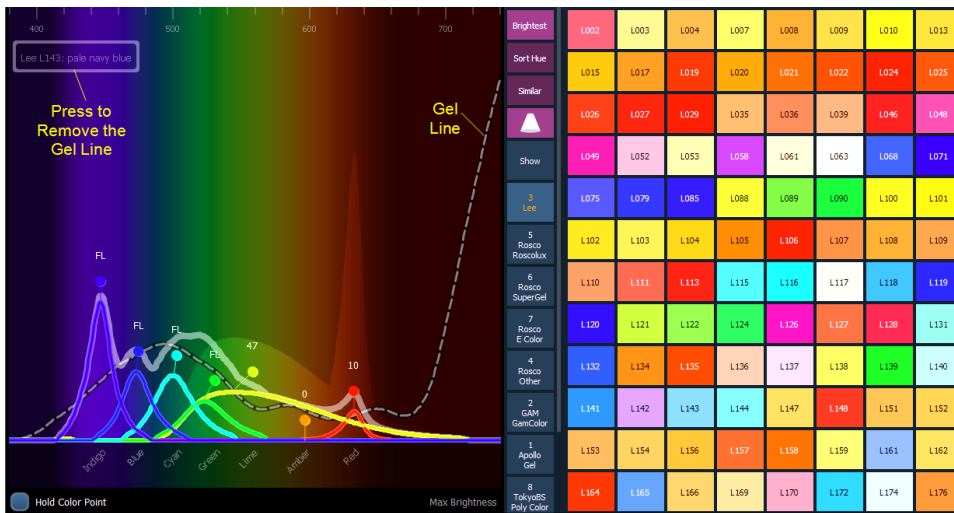

{**Hold Color Point**} allows you to adjust individual emitters and the other emitters will automatically adjust to hold the color selected. This can only be used with fixtures that have more than three color parameters.

If you are working outside of this display, holding down [**Color**] while adjusting the encoders will cause Hold Color Point behavior.

## Home

Eos is equipped with a [**Home**] hardkey. As with the {**Home**} touchbutton on the Encoder Display (see [Home \(on page 178\)](#)). This hardkey allows you to home a specific parameter. Additionally, you may home all of a channel's non-intensity parameters or home only a specific category (I, F, C, B).

Homing a channel, category, parameter, or submaster will return it to the default value.

- [**1**] [**Home**] [**Enter**] - homes all parameters for channel 1, except intensity.
- [**1**] [**Color**] [**Home**] [**Enter**] - homes all color parameters for channel 1.

- **[Group] [1] [Color] [Focus] [Home] [Enter]** - homes the color and focus parameters of all channels in group 1.
- **[Sub] [1] [Home] [Enter]** - homes submaster 1.
- **[Sub] [1] [Thru] [Home] [Enter]** - homes all submasters.

You can select a preset to provide home values for all non-intensity parameters (instead of fixture library default values) when home commands are used. Store a preset with modified home values for only the channel parameters you would like at a different value than default. And then assign that preset to Home in Setup (see [{Home Preset} \(on page 151\)](#)). Since home does not impact intensity, any intensity values stored in the home preset will be disregarded. Any channels that are not included in the preset assigned to Home in Setup will use their library defaults.

## Multiple Intensity Channels

When a fixture with multiple intensity parameters is patched, Eos assigns it a master intensity. The master intensity can be used to control the multiple intensities together. The master intensity is handled in the same way as the intensity of a single intensity channel.

Levels can be set via the level wheel, from the keypad, and the encoders. The other intensities will default to 100%.

Control of the individual intensities of a multiple intensity channel is handled using the parameter buttons in the CIA (see [Manual Control of Non-intensity Parameters \(NPs\) \(on page 175\)](#)) or the encoders (see [Custom Control \(on page 181\)](#)). Levels assigned to the individual intensities will act independent of each other and the master intensity.

- **[1][0][0] {Intens 3} [At] [5][0]** - sets intensity 3 of channel 100 to 50% intensity.
- **[1][0][0] [At] [7][5]** - sets the master intensity of channel 100 to 75% intensity. All intensities for channel 100 will be mastered to 75% unless they have a separate intensity set.

In Table view, Eos will default to showing all intensity parameters associated with the channels.

Color Block DB4 M1					Color		
Ch	Intens	Intens 1	Intens 2	Intens 3	Intens 4	Hue	Saturatn
5	FL	100	50	100	100	0	0

In summary view, the master intensity is shown. If one of the multiple intensities has a value, an '+' will display beside the master intensity.

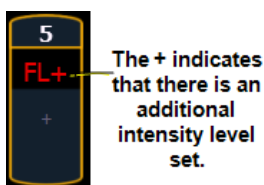

## Multicell Fixtures

Fixtures that have multiple same-type parameters can have a multicell profile assigned to them, as designated by MC in the fixture editor. See [Patching Multicell Fixtures \(on page 113\)](#) for more information.

Multicell fixtures have a master channel with a whole number for a channel number and the appropriate number of additional cells, which will have point numbers for their channel numbers.

To control the whole fixture, select the master channel.

To control individual cells, use `[.]` to put `{Cell}` on the command line.

To control just the master, use `[Shift] & [.]` to put `{Minus Cells}` on the command line. You can also use the syntax `[1] [.] [0]` or `[1] {Cell} [0]` to only control the master.

To select the master and any or all of the cells, you can use the following syntax examples: `[n] [.] [0] [Thru] [n]`, `[n] [.] [0] [+] [n]`, or `[n] [.] [0] [-] [n]`. The `{Cell}` softkey can be used instead of the `[.]` hardkey.

### Example:

Channel 1 is a multicell fixture with four cells.

- `[1] [At] [Full] [Enter]`

Sets the intensity of the master channel to full. Note that the intensity parameter for cells defaults to full.

- `[1] [.] [1] [At] [5] [0] [Enter]`

Sets only cell one at 50% of the intensity of the master. Cells are a percentage of the master level. `[.]` puts cell on the command line.

This can be especially useful when applying effects or palettes.

### Example:

Channel 1 through 4 are multicell fixtures with four cells.

- `[1] [Thru] [4] [Color Palette] [1] [Enter]`

Sets channels 1 through 4 to color palette 1. All four cells of each fixture are set to color palette 1, which is red.



- `[1] [Thru] [4] [Color Palette] [1] Thru] [4] [Enter]`

Channel 1 with its four cells will be set to color palette 1, channel 2 will be set to color palette 2, and so on.



- `[1] [Thru] [4] [.] [Color Palette] [1] Thru] [4] [Enter]`

For each of the channels, cell 1 will be in color palette 1, cell 2 in color palette 2, cell 3 in color palette 3, and cell 4 in color palette 4.



With a cell selected you can apply data to the master channel as long as the cell does not also have that parameter. When you have selected a cell, if you apply data that does not apply to the master, Eos understands to apply it to the cells instead. In the example above, IF the master had color parameters, this action would apply color data ONLY to the master.

Cells will not send data to other cells. Table view is helpful for seeing which cells control what parameters.

Alleda B EYE K10 Extended MC				Focus		Color					
Ch	Intens	Pan	Tilt	Red	Green	Blue	White	Hue	Saturatn	Color Mix	Color Temperature
505	FL	48	-33	100	100	100	100	0	0	0	0
.1	FL			100	100	100		0	0		
.2	FL			100	100	100		0	0		
.3	FL			100	100	100		0	0		

### Example:

Cell 2 of a fixture is currently selected. You can adjust the encoders for pan and tilt even if the master actually controls those parameters. The cell will send that information to the master. This allows for greater ease of control.

The following are additional multicell syntax examples:

- **[5] [.] [2] [+] [+]** - pressing **[+]** twice will put channel on the command line.
- **[5] [.] [Thru]** - automatically puts the first cell's number on the command line before the **[Thru]** command.
- **[5] [.] [1] [Thru] [Enter]** or **[5] [.] [1] [Thru] [At]** - automatically puts the last cell's number on the command line before a **[Enter]** or **[At]** command.
- **[5] [.] [-] [4] [Enter]** - selects all of the cells except cell 4.
- **[1] [+] [+] [2] [.] [3] [Enter]** - selects all of channel 1, and only cell 3 of channel 2.
- **[1] [+] [3] [.] [2] [Shift] & [.]** - appending **[Shift] & [.]** after a cell number will post **[All Cells]** to the command line, selecting all cells of channel 1, and only cell 2 of channel 3.

Offset can be very useful when applied to multicell fixtures, and can be useful for creating subgroups. See [Offset \(on page 205\)](#) and [Subgroups \(on page 205\)](#) for more information.

## Lamp Controls

Lamp Controls (Tab 31) allow you to execute control functions of selected fixtures such as calibrate, douse lamp, strike lamp and reset. Each fixture type has its own set of lamp control options which are available to you when you select the fixture from Live and press the **{Lamp Ctrls}** softkey. This information is also available using **[About]** (see [Using About \(on page 365\)](#)).

### Example:

- **[1] [1] [Enter] {Lamp Ctrls}**

-OR-

- **[1] [1] [Enter] [About] {Lamp Controls}**

If the channel is a conventional (intensity-only) fixture, no control options will be displayed. When the selected channel is an automated fixture, options specific to the fixture type will display for use. Available RDM functions will also display here.



Pressing any of these control options will affect the selected channel after a confirmation.

## Using [%] and [-%]

Use [%] and [-%] keys to incrementally change parameter values.

By default, the [%] and [-%] keys are assigned a value of 10. This can be changed in **Setup**. See [Manual Control \(on page 160\)](#) for more information.

## Channel Intensity

When channels are selected, pressing [%] increments the intensity level by 10 (or by the value established in Setup, see [Manual Control \(on page 160\)](#)). Alternatively, you may press [-%] to decrement the intensity level by 10. You may use these keys consecutively to “add to” or “subtract from” the intensity level.

### Example:

Select channels 1 through 10 and set them to an intensity level of 45% from the keypad.

- [1] [Thru] [1] [0] [At] [4] [5] [Enter]

Change the intensity level to 65% using the [%] key, which is set to its default value of 10% in the setup menu.

- [%] [%]

## Non-intensity Parameters

The [%] and [-%] keys may be used to incrementally adjust non-intensity parameters as well.

### Example:

- [1] {Iris} [%] [%]
- {Zoom} [-%] [-%]

## Remainder Dim



**Note:** By default, **[Rem Dim]** will set to zero. In Setup, you can assign a remainder dim value of something other than zero. See [Manual Control \(on page 160\)](#). For the purposes of this discussion, the default value of zero will be used in examples.

**[Rem Dim]** temporarily provides a zero intensity to all channels except those that are currently selected, those that are parked, or those with intensity contributions from submasters. If the remainder dim command is reversed, the stage returns to its previous state. You may use the following commands for remainder dim:

- **[Next]** and **[Last]**- moves through the channel list.
- **[select channels] [Rem Dim] [Enter]** - sets all non-selected channels to zero.
- **[1] [At] [6] <0> [Rem Dim] [2][0] [Enter]** - sets channel 1 to 60% and all non-selected channels active over 20% to a rem dim level of 20.
- **[Rem Dim]**- clears the rem dim function and returns the stage to its previous state

Pressing **[Rem Dim]** again releases all channels from rem dim mode and restores the stage to its previous state. Using the **[Next]** and **[Last]** buttons releases the current selected channel from remainder dim mode and sets its intensity to zero, while selecting the next or last channel and continuing rem dim operation.

### Example:

Assume channels 5 through 9 are selected and set at an intensity level of 50% and channels 10 through 15 are selected and set at an intensity level of 70%. Select channel 9 and dim the remaining channels.

- **[9] [Rem Dim] [Enter]**

Channel 9 is set at an intensity level of 50% and all remaining channels are dimmed to zero.

- **[Next]**

Selecting **[Next]** changes the channel selection to channel 10 which is set at an intensity level of 70%, the level set in the previous state, and all remaining channels including channel 9, are dimmed to zero.

- **[Rem Dim]**

Pressing **[Rem Dim]** again will return all channels to their previous levels.

**[Rem Dim]** can be used in groups including the use of **[Next]** and **[Last]** buttons to progress through the channels within the selected group.

### Example:

Assume you have group 1 selected (includes channels 1 through 10) with an intensity value of 50%, group 5 selected (includes channels 11 through 20) with an intensity value of 70%, and group 7 selected (includes channels 21 through 30) with an intensity value of 100%

- [Group] [1] [At] [5] [Enter]
- [Group] [5] [At] [7] [Enter]
- [Group] [7] [At] [Full] [Enter]

Select only Group 1 and dim the remaining Groups using the **[Rem Dim]** feature.

- [Group] [1] [Rem Dim] [Enter]

Channels 1 through 10 are selected with an intensity value of 50%, and all remaining channels are at a 0% intensity. You may progress channel by channel through the selected group (Group 1, channels 1 through 10) using the **[Next]** or **[Last]** key. Each press of the **[Next]** or **[Last]** key cycles you through only the channels of the selected group.

Pressing any other key terminates the **[Rem Dim]** mode and leaves channels at their remainder dim value.

You can set the dim level for all remainder dim commands in Setup (See [Manual Control \(on page 160\)](#)). When set to a value other than zero, all rem dim commands will bring intensity to this level instead. However it won't bring an intensity up. For example, if the rem dim level in setup is set to 50%, **[Rem Dim]** will drop any value above 50% to 50%, but not add intensity to any channels below 50%.

It is possible to override the dim level temporarily by specifying a level after the **[Rem Dim]** command.

**[Rem Dim]** can also be used to exclude channels from a submaster or cues during a **[Record]**.

### Example:

Using **[Rem Dim]** You can modify which channels are recorded in the submaster. For this example, assume that channels 1 through 10 are at full. You've recorded that to submaster one.

Using **[Rem Dim]**, you can modify the record so only channels 1 through 5 are recorded to the submaster.

- [1] [Thru] [1] [0] [At] [Full] [Enter]
- [Record] [Sub] [1] [Enter]
- [1] [Thru] [5] [Record] [Sub] [1] [Rem Dim] [Enter]

A **[Rem Dim]** command can also be used on a selective cue record. It will force any channels not included in the record, but that are tracking forward from a previous cue, to zero.

## Rem Dim /

Rem Dim levels can either be an absolute value, such as Full or 50%, or a proportional value, which would set the levels to a percentage value of their current levels. To use a proportional value, press **[/]** before entering the percentage value.

### Example:

Assume that channels 1 through 10 are selected and set to an intensity level of 60. Select channel 1 and dim the remaining channels.

- **[1] [Rem Dim] [/] [5][0] [Enter]**

Channels 2 through 10 will be dimmed to 30.

## Highlight and Lowlight

Eos can be placed in Highlight mode. Channels selected while in this mode will either go to a default setting, or to a value provided by a highlight preset (established in setup, [Manual Control \(on page 160\)](#)). Modifications can then be made to those channels. Any changes will be maintained when the highlight mode is removed.

To place Eos in highlight mode, press **[High] [Enter]**. To place Eos Ti, Gio, Gio @ 5, Ion Xe, and Element 2 in highlight mode, press **[High] [Enter]**. The command line will show that highlight is currently in use.

If no highlight preset is established, or for channels that have no value stored in the highlight preset, the following values will be applied to channels as they are selected:

- Intensity - full
- Focus parameters - no change from present state
- Color parameters - home value
- Shutter parameters - no change from present state
- Image parameters - home value
- Form parameters - no change from present state

### Example:

1. **[Group] [1] [High] [Enter]** - places channels 1 through 5 in highlight.
2. **[Next]** - specifies channel 1.

- 1 is in the highlight value.
- 2 - 5 are in the lowlight value.
- All other channels go to the defined rem dim level.

You may assign both a highlight and a lowlight preset in setup (see [Manual Control \(on page 160\)](#)). Any preset may be used. Channels with only one parameter included in the preset assigned to Highlight and Lowlight will not reset other parameters back to their default highlight values (see above).

On a command line with a channel selection, you can use **[Shift] & [High]** to go into Highlight mode and send the selected channels to the default Highlight setting. This command will self terminate the command line.

If you just use **[High]**, the command line will be cleared.

## Lowlight Preset

The **{Lowlight Preset}**, which is set in **Setup> User> Manual Control >Lowlight Preset**, is used to define the behavior of specified but not selected channels while using **[Next]/[Last]** in highlight mode. When in highlight mode, **[channel list]** or **[Group] [n] [Enter] [Next]** will select the channel list or group and isolate the first channel.



For example, **[High] [Enter] [6] [Thru] [1][5] [Enter] [Next]** specifies channels 6 through 15 but channel 6 is the only channel selected. 6 is at the highlight level and 7 through 15 are at their lowlight levels. Pressing **[Next]** again will put channel 7 at the highlight level and 6 plus 8 through 15 at their lowlight levels. If there is no lowlight preset, these channels are not affected.

## Temporary Highlight Level

The highlight preset can be overridden by setting a temporary highlight level. Using **[High] [At] [5][0] [Enter]** overrides the highlight preset and sets the highlight level to 50. Non-intensity parameters are not affected and will use the default highlight setting or the highlight preset.

The temporary highlight level will remain until **[High]** is pressed again or the channel is no longer selected.

## Highlight/Lowlight Rem Dim

In addition to the highlight and lowlight presets, there is also a setting for **{Highlight Rem Dim}** in Setup. See [Manual Control \(on page 160\)](#). When enabled and highlight mode is active, the intensity for all **non-selected** channels are automatically set to the Rem Dim value established in setup, if that Rem Dim value is lower than the channel's current intensity. This can be used to help further isolate the channels you are working with in Highlight Mode

If you do not wish to enable Rem Dim globally in Setup, you can specify a rem dim on the command line for temporary use. Rem Dim will use the **{Live Rem Dim}**, as specified in setup. See [Manual Control \(on page 160\)](#).

- **[High\_Low] [Rem Dim] [Enter]**

To temporarily override the **{Highlight Rem Dim}** option in Setup, you can use either of the following syntax examples:

- **[channel list] [Highlight] [Rem Dim] [n] [Enter]**
- **[channel list] [Highlight] [Rem Dim] [/] [n] [Enter]**

## Sneak

The **[Sneak]** command (when a destination is not provided) removes manual changes from selected channels and allows the channels to **sneak** back to their background states (cue or submaster instruction, if any). Sneaking channels to their previous state is similar to the Expression release function, except sneak has the ability to release in time.

If there is no background state from the playbacks, the channel parameters will be set to their home position. The sneak command follows the sneak timing default established in Setup (see [Manual Control \(on page 160\)](#)), unless a timing value is provided as part of the sneak command.

The playback status display will show a red counter for sneak time. If multiple sneak times are being used, the most recently fired sneak time will be displayed. For an example of the sneak counter, see [Indicators in the Playback Status Display \(on page 64\)](#).

The sneak command can also be used to send a channel parameter to a specific destination, either with or without timing. The following examples illustrate the various methods of using the sneak command:

- **[channel list] [Sneak] [Enter]** - releases manual control, setting parameters to their background state. If there are current values for those parameters from a playback, those are the values that will be restored. If there are no values from a playback, the parameters are set to home (or default) position.
- **[channel list] [Color] [Sneak] [Enter]** - sneaks color of the selected channels to the default or background state.
- **[5] [At] [5]<0> [Sneak] [8] [Enter]** - sneaks channel 5 to 50% in 8 seconds.

- **[Sneak] [Enter]** - when no channels are selected, restores all channels with manual values to their background state.
- **[Sneak] [Sneak]**- puts **{AllINPs} [Sneak]** on the command line, which sneaks out all non-intensity parameters. **[Sneak] [Sneak]** is a self-terminating command.
- **[Sneak] <Time> [3] [Enter]** - restores all channels with manual values to their background state in 3 seconds.
- **[Select Active] [Sneak] [Enter]** - selects all channels with intensity above zero and restores them to their background state, using default sneak times.
- **[Group] [5] <Color Palette> [9] [Sneak] [Enter]** - selects group 5 and sneaks it to color palette 9 using default sneak time.
- **[Group] [3] [At] <Color Palette> [1] [Sneak] <Time> [7] [Enter]** - selects group 3 and sneaks it to color palette 1 in 7 seconds.
- **[Sub] [4] [At] [5] [0] [Sneak] [2] [Enter]** - selects submaster 4 and sneaks it to 50% in 2 seconds.



**Note:** When recalling a reference from the direct selects to use with the sneak command, the sneak command has to be entered before the reference.

- **[Chan][1] [Sneak] {Preset 1}**- selects channel 1 and sneaks it to preset 1 using default sneak time.
- **[Chan][2][Sneak]<Time>[2]{Intensity Palette 3}**- selects channel 2 and sneaks it to intensity palette 3 in 2 seconds.
- **[Shift] & [Sneak]** - makes any manual data unmanual. The values will remain but they will no longer be available for **[Update]** or **[Record Only]** operations. When used with an empty command line, this will affect any and all manual data. When used with a channel selection, only those channels will be affected.

## Select Keys

The following select functions are available:

- [Select Last](#)
- [Select Active](#)
- [Select All](#)
- [Select Manual](#)

### Select Last

The **[Select Last]** key allows you to reselect whatever the previous channel selection was. This includes multiple channel selections, groups, etc. Using **[Select Last]**, Eos will recall your last selection and leave it unterminated for further operation. This will work for a loop of the last five selections.



**Note:** If any manual control action is taken immediately after a **[Record]**, **[Record Only]**, or **[Update]** command, the previously selected channels will automatically be reselected.

### **[Shift] & [At] and [Shift] & [Enter]**

- **[Shift] & [At]** - recalls last channel(s) and parameters without terminating; does a loop of last five commands.
- **[Shift] & [Enter]** - reselects the last command and leaves it unterminated; does a loop of last five commands.

## Select Manual

The **[Select Manual]** key is used to select all channels that currently have manual data. You may use **[Select Manual]** combined with the parameter control keys to capture only certain parameters of a channel with manual data.

The following examples illustrate the various methods to select channels using **[Select Manual]**:

- **[Select Manual] [Enter]** - selects all channels with manual data.
- **[Select Manual] [Color Palette] [1] [Enter]** - selects all channels with manual levels and sets them to color palette 1.
- **[Color] [Select Manual] [Color Palette] [1] [Enter]** - selects only channels with manual color values and sets them to color palette 1.
- **[1] [Thru] [1] [0] [0] [Select Manual] [Enter]** - selects channels between 1 and 100 with manual data.
- **[Select Manual] [Record] [Group] [n] [Enter]** - records channels with manual data to the target group.

## Select Active

The **[Select Active]** key is used to select all channels that currently have intensity levels above zero. Pressing **[Select Active]** once will capture all active levels. Pressing **[Select Active]** twice will capture all active manual levels and those from playbacks except for submasters. Select NonSub Active will post to the command line.

The following examples illustrate the how to select channels using **[Select Active]**:

- **[Select Active] [Enter]** - selects all active channels with intensity levels above zero.
- **[Select Active] [Record] [Group] [x] [Enter]** - records active channels to the target group.
- **[Select Active] [Sneak] [Enter]** - selects all channels with intensity above zero and restores manual control to the background state, using default sneak time, if enabled.
- **[1] [Thru] [1] [0] [0] [Select Active] [Enter]** - selects channels between 1 and 100 with intensity levels above zero.

On a completed command line, using **[At]** or **[Select Last]** after **[Select Active]** or **[Select Manual]** will post the numeric channel list to the command line.

For example, cue 1 is active, and has channels 1 through 5 at full. Using the syntax, **[Select Active] [Enter] [At]** will post channels 1 through 5 onto the command line.

Another example, Channels 10 through 20 have a manual level of 75. Using **[Select Manual] [Enter] [Select Last]** will put channels 10 through 20 onto the command line.

## Select All

Pressing **[Shift] & [Select Last]** will give the additional softkey option, **{Select All}**. **{Select All}** will select all channels.

## [-] Select Manual or Select Active

**[-] [Select Manual]** or **[-] [Select Active]** can be used to modify channel selections. Using **[-] [Select Manual]** will select all of the channels in the list except those that have manual data. Using **[-] [Select Active]** will select all of the channels in the list except those that are active.

- **[1] [Thru] [2] [0] [-] [Select Manual] [Enter]** - selects channels 1 through 20 except any channels that currently have manual data.
- **[1] [Thru] [2] [0] [-] [Select Active] [Enter]** - selects channels 1 through 20 except any channels that are currently active.

## Channel Check

Channel check allows you to quickly step through all of your patched channels. This is useful for checking lamps or checking focus.



**Note:** *Parked addresses will not be affected by the channel check feature.*

---

The following examples illustrates how to use the channel check feature:

- **[1] [At] [7] <0> {Chan Check} [Enter]** - brings channel 1 to 70% intensity.
- **[Next]** - channel 1 returns to its background state and channel 2 is set to 70% intensity.
- **[Next]** - channel 2 returns to its background state and channel 3 is set to 70% intensity.

Use **[Next]** or **[Last]** to progress through the channel list to complete the channel check. Any other key press other than **[Next]** or **[Last]** will terminate channel check mode.

## Address at Level

The **[Address/Patch]** key in Live is used to send level information directly to an output address.

- **[Address/Patch] [5] [Full] [Enter]** - sets output address 5 to full. It will return to its previous level once the command line changes.
- **[Address/Patch] [2] [/] [1] [At] [/] [2][3][0] [Enter]** - sets universe 2, address 1 at DMX value 230.

With **[Address/Patch]** on the command line, you can use the level wheel to adjust the level.

After using the **[Address/Patch]** command, **[Next]** and **[Last]** may be used to increment the address number and set it to the same level.

Addresses return to their previous level once the command line is cleared, or **[Next]/[Last]** is used to increment to the next address.



**Note:** *This feature is useful when you want to perform an address or dimmer check.*

---

## Address Check

Address check allows you to quickly step through all of your patched addresses.

Address check differs from [Address at Level \(above\)](#) because it skips non-intensity parameters of patched addresses. Since address check follows the current flexichannel state, it can be used with all channels to identify unpatched channels, or with flexi-patched to only show the intensity addresses of patched channels.

- **[Address/Patch] [1] [At] [Full] {Check} [Enter]** - brings address 1 to full intensity.

Use **[Next]** or **[Last]** to progress through the address list to complete the address check. Any key press other than **[Next]** or **[Last]** will terminate address check mode.

## Flash

Using the **{Flash}** softkey in Live will bring a channel or address to full, and then every other second the level will move to 15%. That will hold for 1 second, and then the level will return to full. The channel or address will keep flashing until either the command line is cleared, or **[Next]/[Last]** is used to increment to the next channel or address.

- **[1]{Flash}** - will bring channel 1 to full, then to 15%.
- **[Next]** - channel 1 returns to its previous state and the intensity for channel 2 will flash.
- **[Address/Patch][1][0]{Flash}** - will bring address 10 to full, then to 15%.

## **Flash On & Flash Off**

Pressing **[Shift] & [Full]** together will put all the selected channels at full and "Flash On" will be posted to the command line.

Pressing **[Shift] & [Out]** together will put all the selected channels to out and "Flash Off" will be posted to the command line.

Releasing the keys will return the channels to their previous state.



# Chapter 7

## Using Groups

---

About Groups .....	204
Recording Groups Live .....	204
Selecting Groups .....	208
Opening the Group List .....	208
Using Groups as a Channel Collector .....	209

## About Groups

Groups are channel selection devices used for fast recall of specific channels. A maximum of 1000 groups can be recorded. Once recorded, they are accessible from the keypad, direct selects, and through the displays.

## Recording Groups Live

Record groups of channels that you want to have available for fast recall later. Groups can be stored as whole numbers (such as Group 5) or as decimals of tenths, hundredths, or thousandths (such as Group 2.5, Group 7.65, Group 3.131). Only whole number groups can be stored using the direct selects; any decimal designations for groups must be stored using the keypad.

All groups may be labeled. These labels are then displayed on the direct selects as well as in the group list. Group numbers will not display in either until the groups have been created.

The following syntax examples illustrate the various methods and features available when recording groups:

- **[1] [Thru] [5] [Record] [Group] [7] [Enter]** - records only channels 1 through 5 to group 7.
- **[4] [Thru] [8] [.] [Record] [Group] [2] [Enter]** - records only the cells of the selected multicell fixtures, channel 4 through 8, to group 2.
- **[Record] [Group] [7] [Enter]** - records all channels with non-home values to group 7.
- **[5] [Thru] [9] [Record] {Group 7}** - records channels 5 through 9 to group 7 using the direct selects.
- **[3] [Thru] [8] [Record] [Group] [8] [.] [5] [2] [Enter]** - records channels 3 through 8 to group 8.52.
- **[-] [3] [Record] [Group] [7] [Enter]** - records all channels, except channel "3," to group 7.
- **[Group] [7] [+] [5] [Record] [Group] [9] [Enter]** - records groups 7 and 5 into group 9.
- **[Group] [8] [Group] [9] [Record] [Group] [1] [0] [Enter]** - records groups 8 and 9 into group 10.
- **[Record] [Group] [7] [Label] [name] [Enter]** - records as above and adds a label to the group.
- **[Record Only] [Group] [7] [Enter]** - records channels with manual data to group 7.
- **[Record Only] {Group 7}** - records channels with manual data to group 7 using the direct select.

## Ordered Channels

When recording groups, channels are ordered in the group based on their selection order when the group is stored. This ordering is useful when combined with **[Next]** and **[Last]** functions, and when applying effects to groups.

### Example:

If you record a group by selecting channels in the following order:

- **[1] [+] [3] [+] [5] [Thru] [9] [Record] [Group] [1] [Enter]**

Later you select Group 1 and press **[Next]**, the channels will be accessed, one at a time, in the same order in which they were initially selected.

If new channels are added to an ordered group using an update command, those channels are added to the end of the channel list from an ordering perspective.

When a group is previewed using the Group List, the display defaults to showing the ordered view. Channels can be reordered as needed from this list. Use the **[Format]** key to change to a numeric listing of channels.



## Example:

- [1] [0] [Thru] [2] [Record] [Group] [1] [Enter]

This will record channels 10 through 2 to Group 1, and then if you select the group you can cycle through the channels using **[Next]** starting with 10, then 9, then 8, and so on.

The following softkeys are available:

- **{Insert Before}** - use to insert a new channel after the specified channel within a group.
- **{Insert After}** - use to insert a new channel before the specified channel within a group.
- **{Reverse}** - use to place a group's channels in reverse order.
- **{Random}** - use to place a group's channels in a random order.
- **{Reorder}** - use **{Reorder}** to rearrange the channels to numeric order in a group.
- **{Offset}** - See [Offset \(below\)](#) for more information.

## Subgroups

You can create subsets of channels within a group by using **[Shift] & [/]**. **[Shift] & [/]** to create parentheses. The subgroups will display within those parentheses.

These subsets of channels or subgroups are treated as a single channel in the following ways:

- When applying absolute or relative effects from live, the subgroups are treated as a single channel by the effect.
- When setting a range of step's channels on a step based effect, the subgroup will not be spread out amongst multiple steps.
- When the group is selected and next/last is pressed, each subgroup is traversed.
- When a group has subgroups, **{Reverse}**, **{Reorder}**, and **{Random}** in the group editor will affect the subgroups instead of the channels in each subgroup. **{Reorder}** will order the groups based on the first channel in each subgroup.
- Subgroups can be created either in the group list or Live.

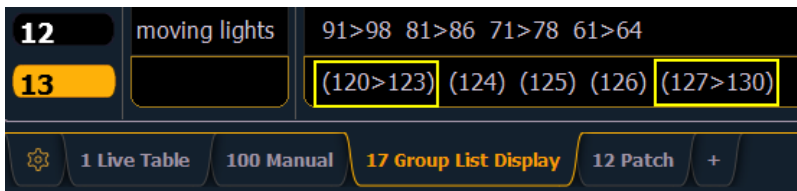

To create a subgroup in Live:

- [Shift] & [/] [1] [Thru] [4] [Shift] & [/] [Record] [Group] [2] [Enter]

To create a subgroup in the group list index:

- [Group] [2] [Enter] [Shift] & [/] [1] [Thru] [4] [Shift] & [/] [Enter]

## Offset

You can use the **{Offset}** softkey to aid in channel selection prior to storing groups, submasters, presets, palettes, effects, and using park. When **{Offset}** is pressed, a channel distribution display will open.

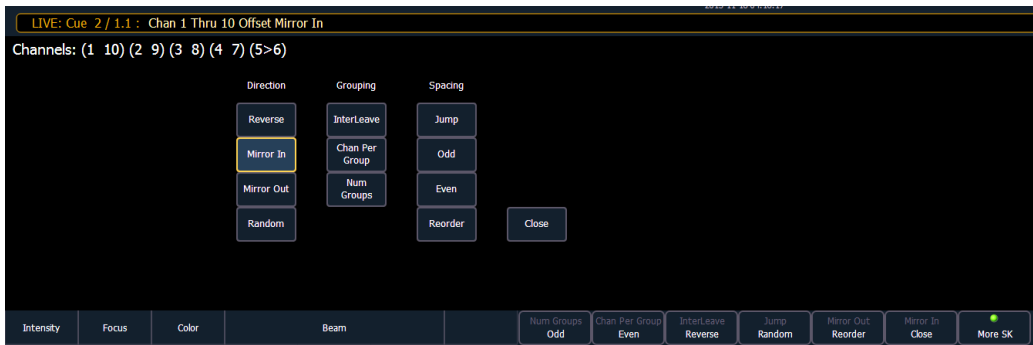

The following options are available as extensions of **{Offset}**. Options can be used together. These extensions can be used to create *Subgroups (on the previous page)*. To close the Offset display, press **{Close}**.

## Direction

- **{Reverse}** creates a group with the channels in the reverse order that they were selected in.
- **{Mirror In}** creates subgroups of channels that mirror inward.
  - **[1] [Thru] [8] {Mirror In} [Enter]** would create 4 subgroups in this order: (1,8) (2,7) (3,6) (4,5)

Ch 1	Ch 2	Ch 3	Ch 4	Ch 5	Ch 6	Ch 7	Ch 8
X							X
	X					X	
		X			X		
			X	X			

- **{Mirror Out}** creates subgroups of channels that mirror outward.
  - **[1] [Thru] [8] {Mirror Out} [Enter]** would create 4 subgroups in this order: (4,5) (3,6) (2,7) (1,8)

Ch 1	Ch 2	Ch 3	Ch 4	Ch 5	Ch 6	Ch 7	Ch 8
			X	X			
		X			X		
	X					X	
X							X

- **{Random}** creates a random order to the channels.

## Grouping

- **{Chan Per Group}** creates a specified cluster of channels.
  - **[1] [Thru] [1][2]{Chan Per Group} [3] [Enter]** would create these 4 subgroups of 3 channels each: (1,2,3) (4,5,6) (7,8,9) (10,11,12).
- **{InterLeave}** creates a number of distributed sets of channels, that are not clustered together.
  - **[1] [Thru] [1][2]{Chan Per Group} [4] {InterLeave} [Enter]** would create these 4 subgroups: (1,4,7,10) (2,5,8,11) (3,6,9,12).
  - **[1] [Thru] [5] [+] [1][1] [Thru] [1][5] [+] [2][1] [Thru] [2][5] {Chan Per Group} [3] {InterLeave} [Enter]** would create these 5 subgroups: (1,11,21) (2,12,22) (3,13,23) (4,14,24) (5,15,25).

- **{Num Groups}** creates a specified number of subgroups.
  - **[1] [Thru] [1][2]{Num Groups} [3] [Enter]** would create these 3 subgroups: (1,2,3,4) (5,6,7,8) (9,10,11,12).

## Spacing

- **{Jump}** is used to skip over a specified number of channels.
  - **[1] [Thru] [1][2]{Chan Per Group} [3] {Jump} [1] [Enter]** would create these 3 subgroups of 3 channels each: (1,2,3) (5,6,7) (9,10,11). Channels 4, 8, and 12 will be jumped over and will not be in the subgroups.
- **{Odd}** selects only the odd numbered channels.
- **{Even}** selects only the even numbered channels.
- **{Reorder}** is used to reorder the channels of a group into numeric order.

## Editing and Updating Groups in Live

Existing groups can be updated or re-recorded in Live. If you re-record an existing group, a confirmation is required (unless disabled in Setup). By re-recording a group, you **replace** the contents of the group, you do not add to it. Updating a group does not require a confirmation and adds channels to the group, rather than replacing them.

Other editing or updating examples are:

- **[Group] [x] [Label] [Label] [Enter]** - clears the label.
- **[Group] [x] [Label] [name] [Enter]** - stores a new label.
- **[1] [Thru] [5] [Update] [Group] [n] [Enter]** - adds channel 1-5 to existing Group n.

For record examples, please see [Recording Groups Live \(on page 204\)](#).

## Multicell Fixtures In Groups

There are multiple different ways to create groups using multicell fixtures.



**Note:** The following examples are created in the group list. Groups can also be recorded in Live. See [Recording Groups Live \(on page 204\)](#)

---

To create subgroups of the whole multicell fixtures:

- **[Group] [3] [1] [Enter] [5] [0] [0] [Thru] [5] [0] [3] [Enter]**

To create a group with only the cells of the selected multicell fixtures:

- **[Group] [3] [2] [Enter] [5] [0] [0] [Thru] [5] [0] [3] [.] [Enter]**

To create a group with only certain cells of multicell fixtures:

- **[Group] [3] [3] [Enter] [5] [0] [0] [Thru] [5] [0] [1] [.] [1] [Thru] [2] [Enter]**

To create a group with only the master cells:

- **[Group] [3] [4][Enter] [5] [0] [0] [Thru] [5] [0] [3] [Shift] & [.] [Enter]**

To create subgroups with only specific cells:

- **[Group] [3] [5] [Enter] [5] [0] [0] [.] [1] [Shift] & [/] [5] [0] [1] [.] [1] [Enter]**

<b>31</b>		(500) (501) (502) (503)
<b>32</b>		500>503 Cells Only
<b>33</b>		500>501 Cell 1>2
<b>34</b>		500>503 Minus Cells
<b>35</b>		(500 Cell 1) (501 Cell 1)

You can also use the **{Offset}** softkeys to aid in create of groups and subgroups. See [Offset \(on page 205\)](#) for more information.

## Selecting Groups

Groups may be selected from the control keypad or the direct selects.

To select a group:

- **[Group] [1] [Enter]** - selects all channels in Group 1
- **[Group] [1] [At] [5] <0> [Enter]** - selects Group 1 and places all channels within at 50%
- **{Group 1}** - Selects all channels in Group 1

If **[Next]** is used after a group selection, it accesses the first ordered channel in that group. Pressing it again accesses the second ordered channel in that group, and so on. **[Next]** - used after the last channel in the group - accesses the first channel in the group again.

**[Last]** may be used with group selects similar to **[Next]**. Press **[Select Last]** to reselect the entire group.

## Deleting Groups

When you delete a group, the group number and all contents from the Group List Index and Direct Selects are deleted. Delete commands require a confirmation by default. This can be altered in the default settings. If you disable confirmations, the second enter is not required in the following examples:

Group deletion features include:

- **[Delete] [Group] [5] [Enter] [Enter]** - deletes group 5.
- **[Delete] [Group] [3] [+] [Group] [5] [Enter] [Enter]** - deletes groups 3 and 5.
- **[Delete] [Group] [3] [Thru] [9] [Enter] [Enter]** - deletes groups 3 through 9.
- **[2] [Delete] [Group] [7] [Enter]** - deletes channel 2 from group 7.

## Opening the Group List

The group list allows viewing and editing of groups.

To open the group list you can:

- Press **[Group] [Group]**
- Press **[Tab] [1] [7]**

You can navigate within the group list using **[Next]** and **[Last]** or by selecting the group you want to work with.

## Ordered View and Numeric View

By default, grouped channels will be displayed in ordered view. Therefore, grouped channels will appear in the order they were added to the group (see [Ordered Channels \(on page 204\)](#)). If you wish to view the channels in numeric view, press the **[Format]** key and the view will be

switched (channels will appear in numeric order from lowest to highest).

This setting is important in defining next/last functionality within groups in live/blind. If left in numeric format, when using **[Next]/[Last]** group selection channels will be selected in numeric order. If left in ordered view, they will be selected based on their order of being stored to the group.

## Editing Groups from the Group List

An existing group can be modified without the need for recording or updating, as follows.

- Select the required group by pressing **[Group] [n] [Enter]**, or using **[Next]** and **[Last]** to navigate through the list.

The selected group is highlighted in gold.

The following actions are possible:

- **[Label] [name] [Enter]** - adds or modifies a group label.
- **[Copy To] [Group] [7] [Enter]** - copies the contents of the selected group to group 7.
- **[2] {Insert Before} [9] [Enter]** - inserts channel 2 into the group, placing it before channel 9 in the ordered view.
- **[2] {Insert After} [5] [Enter]** - inserts channel 2 into the group, placing it after channel 5 in the ordered view.
- **[2] [Delete] [Enter]** - removes channel 2 from, the group.
- **[+] <Chan> [1][0] [Enter]** - adds channel 10 to the selected group.
- **[-] <Chan> [5] [Enter]** - removes channel 5 from the selected group.
- **[+][Group] [1][0] [Enter]** - adds group 10 to the selected group.
- **[-] [Group] [5] [Enter]** - removes group 5 from the selected group.
- **{Random} [Enter]** - rearranges the channels in the group randomly.
- **{Reverse} [Enter]** - reverses the order of the channels within the group.
- **{Reorder} [Enter]** - reorders the channels to numeric order in the group selected.
- **{Offset}** - see [Offset \(on page 205\)](#) for more information.

## Using Groups as a Channel Collector

**[Group]** can be used as a quick way to collect channels from submasters, cues, presets, and palettes.

The following actions are possible:

- **[Group] [Cue] [1]** - selects all the channels in cue 1.
- **[Group] [Sub] [3]** - selects all the channels in submaster 3.
- **[Group] [Int Palette] [5]** - selects all the channels in intensity palette 5.



# Chapter 8

## Using Fan

---

About Fan .....	212
Fanning Parameter Data .....	212
Fan From the Command Line .....	212
Fanning References .....	213
Fanning Timing and Delays .....	213
Using Subgroups with Fan .....	213

## About Fan

Fan provides the ability to spread parameter and timing values in a range across a channel selection set and have those values be evenly spaced. Fan is applied by channel selection or group order. By default, fan operation is from the start channel.

When **[Fan]** is pressed after a channel selection, the softkeys will repaint to the following fan styles:

- **{Center}** - The middle channel in the order is set as the start and will remain unchanged, and the first and last channels will change in different directions. The level wheel will decrease the lower number channels and increase the higher number channels.
- **{Reverse}** - The selected channel order is reversed before applying the fan.
- **{Mirror Out}** - The middle channel in the selected order is used as the starting channel and the first and last channels in the order are the end channels.
- **[1] [Thru] [1][0] [At] [1][0] [Thru] [3][0] [Fan] {Mirror Out} [Enter]** - sets channel 1 to 30%, 2 to 20%, 3 to 10%, 4 to 20%, and 5 to 30%.
- **{Repeat}** - The number of channels that are fanned before the pattern is repeated.
- **[1] [Thru] [1][2] [At] [5][0] [Thru] [7][0] [Fan] {Repeat} [3] [Enter]** - sets channels 1,4,7, and 10 at 50%, 2,5,8, and 11 at 60%, and 3,6,9, and 12 at 70%.
- **{Cluster}** - The channels are put into collections, which contains channels with all of the same value.
- **[1] [Thru] [1][2] [At] [5][0] [Thru] [8][0] [Fan] {Cluster} [4] [Enter]** - sets channels 1 through 3 at 50%, 4 through 6 at 60%, 7 through 9 at 70%, 10 through 12 at 80%.
- **{Random}** - The selected channels are put in a random order before fan is applied.

## Fanning Parameter Data

Fan values can be adjusted with either an encoder or via the keypad. To adjust the fan values with an encoder, select the required channels and provide a baseline, if necessary, followed by **[Fan]**. On Element 2, you will need to use the virtual encoders in the ML display.

If no value is entered, the current values will be used. When using encoders to adjust fan, it is not necessary to specify the parameter to be fanned. This is determined by the encoder used.

- **[1] [Thru] [5] [Fan] [Enter]** - selects the channels 1 through 5 and puts encoders and level wheel into fan mode.
- **[1] [Thru] [5] [At] [5] <0> [Fan] [Enter]** - selects the channels 1 through 5, sets a start level of 50% and puts encoders and level wheel into fan mode.
- **[1] [Thru] [5] [Fan] {Mirror} [Enter]** - selects the channels 1 through 5 and puts encoders and level wheel into fan mode with mirror style.

## Fan From the Command Line

A level or time command that uses **[Thru]** or a list of references is a command line fan command.



**Note:** The **[Fan]** key is not necessary unless a fan style other than the default is needed.

---

To adjust the fan values from the command line:

- **[1] [Thru] [5] [At] [1] <0> [Thru] [5] <0> [Enter]** - sets channel 1 to 10%, 2 to 20%, 3 to 30%, 4 to 40%, and 5 to 50%. This is the default fan adjustment and the **[Fan]** command is not necessary.



- `[1] [Thru] [5] [At] [1] <0> [Thru] [3] <0> [Fan] {Mirror} [Enter]` - sets channel 1 to 30%, 2 to 20%, 3 to 10%, 4 to 20%, and 5 to 30%.

## Fanning References

When fanning references, such as palettes, if there are more than 2 reference lists are used then the data will be referenced data. The fan will be repeated if there are more channels than references.

- `[1] [Thru] [5] [Int Palette] [1] [Thru] [3] [Enter]` - sets channel 1 to IP1, 2 to IP2, 3 to IP3, 4 to IP1, and 5 to IP2.

If the list contains 2 or less references, fan will be set to the levels between the references as absolute data.

- `[1] [Thru] [5] [Int Palette] [1] [Thru] [2] [Enter]` - (Intensity palette 1 is all channels at 0% and Intensity palette 2 is all channels set to 100%.) sets channel 1 to 0%, 2 to 25%, 3 to 50%, 4 to 75%, and 5 to 100% as absolute data.

## Fanning Timing and Delays

Fanning timing and delays work exactly like fanning parameters.

- `[1] [Thru] [5] [Time] [6] [Thru] [1] [0] [Enter]` - sets the discrete times for channel 1 to 6 seconds, 2 to 7 seconds, 3 to 8 seconds, 4 to 9 seconds, and 5 to 10 seconds.
- `[Cue] [1] [Thru] [5] [Time] [6] [Thru] [1] [0] [Enter]` - sets the times for cue 1 to 6 seconds, 2 to 7 seconds, 3 to 8 seconds, 4 to 9 seconds, and 5 to 10 seconds.
- `[Cue] [1] [Part] [1] [Thru] [3] [Time] [6] [Thru] [8] [Enter]` - sets the times for cue 1's parts to part 1 to 6 seconds, part 2 to 7 seconds, and part 3 to 8.
- `[1] [Thru] [5] [Delay] [6] [Thru] [8] [Fan] {Mirror} [Enter]` - sets the discrete delays of channel 1 to 8 seconds, 2 to 7 seconds, 3 to 6 seconds, 4 to 7 seconds, and 5 to 8 seconds.

## Using Subgroups with Fan

[Subgroups \(on page 205\)](#) can be used with the Fan feature. Channels in the same subgroup will act as a single channel when fanned.

### Example:

Group 1 is made up of channels 120 thru 130. Channels 120 thru 123 are one subgroup, channels 124 thru 126 are not in any subgroup, and channels 125 thru 130 are another subgroup.

- `[Group] [1] [Fan] [Enter]`

Selects group 1 and puts it into fan mode. Rolling up the level wheel creates the following result. Channels 120 thru 123 share an intensity, channels 124 thru 126 each have different intensities, and channels 127 thru 130 share an intensity.





# Chapter 9

## Using Mark

---

About Mark .....	216
AutoMark .....	216
Referenced Marks .....	217

## About Mark

Mark is an instruction that automates the process of presetting moving lights to their required state in a cue, prior to fading intensity up. This allows your moving lights to unobtrusively perform non-intensity parameter transitions in an inactive (darkened) state.

Eos provides two different methods to mark lights:

- [AutoMark \(below\)](#)
- [Referenced Marks \(on the facing page\)](#)

On Element 2, only AutoMark is available.

## AutoMark

The AutoMark feature is a system default setting and can be turned on or off at a global level. The system default for this setting is off. To change the default settings see [Cue Settings \(on page 151\)](#)

When AutoMark is enabled, non-intensity parameter transitions will occur in the cue **immediately preceding** the cue in which the changes are stored, if intensity in that cue is moved from zero to any active level. Therefore, the preceding cue “executes” the AutoMark.

AutoMark information is displayed for cues or cue parts. It is not a channel instruction. AutoMarked cues are indicated by an “M” in the M column of the playback status display.

AutoMarks will execute using the time of the cue in which the moves occur (the cue indicated by “M”). The exceptions to this are the mark time in setup, or if discrete timing is stored with the move instruction, in which case the discrete time will be used.

AutoMarks will display the same way in Live and in Blind.

## Conditions Triggering an AutoMark

The following rules determine which channels AutoMark is applied to and how it is deployed:

- The marked cue must have a move instruction for intensity of moving lights above zero or null.
- The marked cue must have a move instruction for non-intensity parameters of those channels.
- AutoMark will not occur if the channel is receiving an intensity instruction from another source (such as a submaster or HTP fader).
- AutoMark must be enabled for an AutoMark to occur. AutoMark is based on the current setting of the default **during playback**. It does not matter what the setting is at the point of record.
- On a “per channel” basis, an AutoMark does not occur until:
  - Any parameter delay time has elapsed **and**
  - The intensity has reached zero and the parameter has completed any previous movement.

## Allowing a Live Move

When AutoMark is “On” it is possible to override it on a per cue (or cue part) basis. The override will be available through a softkey, **{AutoMark Off}**. This softkey is not visible when AutoMark is disabled in default settings.

AutoMark can be disabled on cues/cue parts.

When enabled, the cue that executes the mark will have an “M” in the flags field. If AutoMark is disabled, allowing a live move, a “D” is displayed in the flags field of the cue or cue part where the data is stored.

By using AutoMark with multipart cues, it is possible to have some parameters mark and others move live.

## AutoMark and Timing

An AutoMark will happen in the time of the cue in which is moving (the “M” cue), unless the channel has discrete timing or the mark time has been changed in setup. Discrete timing would override the mark time option in setup. See [Mark Time \(on page 221\)](#) for more information. In which case, the discrete timing will apply to the moves. Discrete timing is applied in the cue where the move instruction is stored.

## Referenced Marks

Referenced marks are user-specified marks that are manually applied to specific channels or parameters. When AutoMarks are disabled, referenced marks may be used. AutoMark and Referenced Marks cannot be used simultaneously.



**Note:** *If you begin programming with AutoMark enabled, and then disable the feature, all of the AutoMarks in the show are converted to referenced marks.*

---

There are essentially two parts to a successful referenced mark. The first part is the cue with the mark flag (set by the user). This is the cue in which any non-intensity parameters will change. This cue is referred to as the **marked cue**.

The second part is the cue with intensity value for the channels in question. This is referred to as the **source cue**. This is also the cue where the non-intensity moves are stored.

In order to use mark properly, you **must specify** channels to be marked in the source cue. Eos will not assume all moving lights apply to any given mark.

There are two ways to apply a referenced mark. You can apply a mark flag at a cue level and then subsequently reference that flag in a later cue, **or** you can apply a mark in a cue and reference back to an earlier cue.

Referenced marks are useful because the non-intensity parameter data is stored in the cue that actually fades the lights up. Therefore, any changes to the non-intensity parameter data is modified in the source cue. You do not need to worry about changing it in the marked cue.



**Note:** *When bringing up the intensity of a fixture that is in a marked state, all the parameters of that fixture will be made manual and the current NPs settings will display. This is done so you won't need to use **{Make Manual}** when storing to a cue.*

---

## Setting Referenced Mark Flags

You can apply a mark flag by pressing:

- **[Cue] [n] [Mark] [Enter]**

This sets a flag (M) on a cue for later marking activity. In subsequent cues, when channels are marked, they will preset for movement in this cue (unless told to mark elsewhere).

When you are building a cue containing channels that you want to mark, do the following:

- **[select channels] [Mark] [Enter]**
- Store the cue, following normal procedures. Eos will automatically look backwards in the cue list for the first mark flag it encounters.

### Example:

Assume you had placed a mark flag on Cue 10 (this becomes the Marked Cue).

- **[Cue] [10] [Mark] [Enter]**

Later you store Cue 12 with a mark instruction on channels 1-10 (this becomes the Source Cue).

- **[1] [Thru] [10] [Mark] [Enter]** - Note that channels 1-10 are displayed with a red "M" in the upper right corner.
- **[Record] <Cue> [1] [2] [Enter]**

Since no specific mark instruction was given to the channels in cue 12, the channels will mark back to the first "M" encountered in the preceding cues of the cue list, provided that the intensity for those channels is "out" throughout the duration of the mark.

When Cue 10 is played back, the non-intensity parameters of channels 1-10 will fade to the values stored in Cue 12. Then in Cue 12, the intensity will fade up on those channels.

## Mark Display Indicators

In the previous example, indications that a mark had been placed are as follows. Cue 10 would be shown with a mark flag (M) in the cue list. In addition, when cue 10 is played back, channels 1-10 will show a green "MK" in the intensity field, while the non-intensity parameters would show the source cue number in green "Q12" (the MK in the intensity field is green if, in cue 10, the lights are fading to zero and then the NPs are marking. If, in cue 10, channels 1-10 were already at zero, a magenta "MK" will be displayed).

The source cue (cue 12) would include a green "M" next to the intensity level and any non-intensity parameter values would be displayed in green. Also, in the cue list, cue 12 would have an "R" in the mark flags field. If a mark has been placed on a cue, but that cue is not yet marking any lights, the "M" will be represented as "m". You will also see an "m" if the mark is no longer in tact.

## Priority Mark

When setting mark cues, you assign a priority marking using the softkeys **{High Priority}** and **{Low Priority}**. When marking, channels will attempt to mark to high priority cues first. Cues that are flagged with just Mark are considered normal priority. Channels will attempt to mark to them second if a high priority cue can not be used. Low Priority cues will be used last if a high or normal priority cue could not be used.

Priority marked cues display indicators in the PSD. See [Mark Symbols \(on the facing page\)](#) for more information.

## Applying Flags as Channels are Marked

You may also apply a mark flag to a previous cue by doing the following:

- **[select channels] [Mark] [Cue] [5] [Enter]**
- **[Record] [Cue] [8] [Enter]**

This would mark cue 5 to perform any non-intensity moves stored in cue 8. The display indicators for this mark would be the same as shown in the previous example. As long as intensity is at zero within the cue range, if there are any non-intensity move instructions for these channels between these two cues, they will be removed.

It is also possible to mark only certain parameters for marked moves, while allowing live moves for other parameters.

### Example:

If you wanted to mark only focus, and allow all other parameters to transition while the light is fading up, you can press:

- [1] [Thru] [10] [Focus] [Mark] [Enter]

## Mark Earliest

The **{Earliest}** command can be used with **[Mark]** to mark the channel into the cue after the last intensity moved from a nonzero level to 0. The mark is stored and behaves exactly as if you had typed the cue number instead of **{Earliest}**. This works in blind, or in live if you record afterwards.

### Example:

Cue 2 moves the intensity for channel 1 to 0, Cue 3 thru 4 have no intensity for channel 1, and Cue 5 has the intensity move to full. From Cue 5:

- [1] [Mark] {Earliest} [Enter]

This will work the same as [1] [Mark] [Cue] [3] [Enter], and will mark from cue 3 to cue 5.



**Note:** **[Mark] {Earliest}** will mark through block cues or blocked intensity moves of 0, until it finds the earliest intensity move to 0. If the cue immediately before the cue being marked is the earliest intensity move to 0, it will mark in that cue.

**{Earliest M}** will mark to the earliest cue that already has a mark flag. If a mark cue doesn't exist, **{Earliest M}** will behave like **{Earliest}** and will mark to the earliest possible cue.



**Note:** **{Emergency Mark}** can be used to automatically set a mark flag if you had not previously done so. If using **{Earliest M}** and no cue with a mark flag has already been set, **{Emergency Mark}** will set a mark flag. See [Record Defaults \(on page 159\)](#) for more information.

## Mark Symbols

The symbols that appear in the Mark flag column of the Playback Status Display and the Cue List Index include:

### Live

- **MK** - Indicates the channel is marked for a later cue. The cue number is indicated in the other categories (see "Q" below).
- **Q** - Found in the non-intensity categories of a marked channel. The "Q" is followed by a number indicating which cue the mark is in preparation for.
- **M** - Indicates a mark is placed, but manual, and must be stored. Is blue when stored. "m" indicates cue is not marking.

## Playback Status Display

- **D** - AutoMark is disabled.
- **M** or **m** - Indicates a marked cue. “M” indicates an AutoMark or a reference mark that is used by a subsequent cue. “m” indicates a reference mark that is currently unused by any subsequent cue. Found in the “Flags” area.
- **R** - Indicates the source cue which refers back to an earlier mark. Found in the cue display “Flags” area.
- **+** - Indicates a cue is both a marking and reference cue when displayed in the mark flag.
- **--** - Indicates a dark move, a cue that has any non-intensity parameters moving on channels whose intensity is at 0.
- **x** - Indicates that a mark has been placed, but the mark has been broken. If possible, Eos will AutoMark the lights.
- **mh** - Indicates that a cue has been flagged as high priority mark, but nothing is marking to it yet.
- **Mh** - Cue has been flagged as high priority, and lights are marking to it.
- **ml** - Indicates that a cue has been flagged as low priority mark, but nothing is marking to it yet.
- **MI** - Cue has been flagged as high priority, and lights are marking to it.

## Reference Marks and Timing

Movement of non-intensity parameters in conjunction with a mark will adhere to the following timing rules.

If discrete timing is used for non-intensity parameters:

When channels execute a mark, the moves will use the discrete time(s) assigned to them **in the source cue**.

### Example:

A mark is applied to Cue 5, making it the marked cue.

- **[Cue] [5] [Mark] [Enter]**

Later, channels 1-10 are assigned discrete timing and a mark instruction:

- **[1] [Thru] [1] [0] {Focus} [Time] [8] [Mark] [Enter]**

Then, those channels are recorded into Cue 10:

- **[Record] <Cue> [1] [0] [Enter]**

In this instance, when Cue 5 is executed, channels 1-10 will perform their focus parameter moves in 8 seconds, as specified in Cue 10 (the source cue, which is the source of their move instruction).

If **no** discrete timing is used for non-intensity parameters or mark time is disabled:

When channels execute a mark, the moves will use the time recorded **in the marked cue**.



### Example:

Cue 5 is recorded with a time of 10 seconds.

- [Record] <Cue> [5] [Time] [1] [0] [Enter]

A mark is applied to Cue 5 as above.

- [Cue] [5] [Mark] [Enter]

Later, channels 1-10 are assigned a mark instruction and then recorded into Cue 10 with **no** discrete timing:

- [1] [Thru] [1] [0] [Mark] [Enter]
- [Record] <Cue> [1] [0] [Enter]

When Cue 5 is executed, channels 1-10 will perform their non-intensity parameter changes in 10 seconds, as specified in Cue 5 (the marked cue).

Marked cues that are played out of sequence will fade to their marks immediately. When firing a cue that has a linked cue, the cue will mark like the linked cue is the next cue. The marks will fade using the active cue's timing.

## Mark Time

Mark time is a setup option (**Setup> System> Cue Settings> Mark Time**) which allows you to set the time that mark instructions will use. When **{Mark Time}** is disabled, which is the default, mark instructions will use cue timing unless overridden with discrete timing. When you enter a mark time in setup, all NPs that mark (either through referenced marking or AutoMark) will use this time. The only way to override setup mark time is to use discrete timing. Clearing the **{Mark Time}** field sets it back to disabled. Select **{Mark Time}** and hit **[Enter]** to disable the default mark time.

## Removing Referenced Marks

Mark is a toggle state. Therefore, the first mark command sets a mark. The second removes it.

To remove a mark flag from a cue, press:

- [Cue] [n] [Mark] [Enter]

To remove a mark from a channel:

- [select channel] [Mark] [Enter]



**Note:** *If a mark is removed from a channel in live, the corresponding cue must be updated.*

---

It is also possible to mark to a cue that doesn't exist, and when the mark is stored, Eos will automatically create the cue to mark to.

**Example:**

If cue 2 does not exist yet:

- [select channels] [Mark][2] [Enter]

The command line will display, "Create Mark Cue?"

- [Enter]

When the cue is stored, the system will automatically create a cue 2 and mark the lights to it.

If a light is marked and that mark is later broken (for example being used by a move instruction stored in the mark range), Eos will attempt to repair the mark. This is done by AutoMarking in the cue previous to intensity fading up, if possible. This will be indicated in the cue list by a "\*" in the cue immediately preceding the "R" cue.

# Chapter 10

## Storing and Using Palettes

---

About Palettes .....	224
Palette Types .....	224
Palette Options .....	225
Storing Palettes Live .....	225
Recalling Palettes .....	228
Editing Palettes Live .....	229
Editing Palettes in Blind .....	230
Using By Type Palettes .....	233
Removing Channels from a Palette .....	234
Deleting Palettes .....	234

## About Palettes

Palettes are building blocks that can be used to create presets ([About Presets \(on page 236\)](#)), cues ([About Single Cue List \(on page 250\)](#)), and effects ([About Effects \(on page 324\)](#)).

Palettes are referenced data. This means that when included in presets, cues, or effects, changes to the contents of the palette are propagated into all of the places the palette is stored.

Four types of palettes are available:

- [Intensity Palettes \(below\)](#)
- [Focus Palettes \(below\)](#)
- [Color Palettes \(below\)](#)
- [Beam Palettes \(on the facing page\)](#)

Palettes are a critical component when using moving lights and can save considerable programming time when editing show data.

When recording palettes, three softkey options are available:

- [{By Type} \(on the facing page\)](#)
- [{Absolute} \(on the facing page\)](#)
- [{Locked} \(on the facing page\)](#)

Eos supports up to 1,000 palettes of each of the four types, which can be recorded as decimal (up to three places, 0.001) or whole number (up to 9,999.999). Palettes are automatically filtered into IFCB categories. Color data cannot be placed in beam palettes, intensity cannot be included in focus palettes, and so forth. This makes the process of creating palettes easier, faster and less work. If you need to create a reference that will include a mix of IFCB information, presets can be used. See [About Presets \(on page 236\)](#).

Palettes can be mapped to faders. Please see [Presets and Palettes Fader Properties \(on page 244\)](#) for more information.

## Palette Types

There are four types of palettes:

- [Intensity Palettes \(below\)](#)
- [Focus Palettes \(below\)](#)
- [Color Palettes \(below\)](#)
- [Beam Palettes \(on the facing page\)](#)

### Intensity Palettes

Intensity palettes can easily be created for use with all channels that have intensity parameter data.

### Focus Palettes

Focus palettes can be created for all channels that have pan and tilt functions.

### Color Palettes

Color palettes can be created for all channels that have any color parameter data. Color palettes store any combination of color data, including CMY, RGB, and HS settings, color scrollers and color wheels.

You will find that **[Record Only]**, filter settings and selective store commands will be very useful when storing color palettes.

## Beam Palettes

Beam palettes can be created for all channels that have any beam parameter data. It is rare when storing beam palettes that you will wish to include all of the beam parameters for channels. Therefore, **[Record Only]**, filters and selective store commands will be very useful when storing beam palettes.

## Palette Options

When recording palettes, there are three softkey options:

- *{By Type} (below)*
- *{Absolute} (below)*
- *{Locked} (below)*

### {By Type}

By Type palettes are created with 'default' channels which contain values that can be assigned to any other channel within the same fixture type. By Type palettes can also contain discrete channel values.

By Type palettes will display a 'T' in the lower corner of the direct selects and in the palette lists. A '+' will display after the 'T' if there are channels stored with discrete data. For more information on by type palettes, see [Using By Type Palettes \(on page 233\)](#).

### {Absolute}

Absolute palettes are palettes that when recalled the data is displayed and treated like absolute data applied to a channel. The data is never referenced.

An absolute palette will display with an 'A' in the lower corner of the direct selects and in the palette lists.

### {Locked}

Locked palettes are palettes that are protected from being accidentally changed in Live.

A locked palette will display a "L" in the lower corner of the direct selects and in the palette lists.

Locked palettes can be updated by specifically calling the channels and the record target, **[channel list] [Update] [Record target] [Enter]**. Using **[Update] [Color Palette] [1] [Enter]** would not work in Live for a locked palette. However locked palettes are not protected in Blind.

## Storing Palettes Live

Palettes may be stored in live or blind. There are a variety of methods for determining what data is stored into a palette but **[Record]**, **[Record Only]** and using filters are the most common ways.

When **[Record]** is used, Eos will store the relevant parameter category data (intensity, focus, color or beam) for all channels that are not currently at their default value.

**[Record Only]** is a type of selective store that can be used to store only the relevant parameters that have manual data. Filters and selective storing provide additional methods to control what is stored into a palette.

## Storing Palettes with [Record]

The most common method to create palettes is to store them from Live. Palettes can be numbered from 0.001 through 9999.999, and each can be given a label. **[Record]** will store the relevant current parameter data for all channels with non-default data for the appropriate palette type, as modified by the filter settings.

### Example:

Assume you want to create a custom color using the color picker and store that data to a custom color palette. First you must select channels.

- **[1] [Thru] [1] [1] [Enter]**

Using the color picker, adjust the hue and saturation levels to the desired look. When the color is selected, store the palette.

- **[Record] [Color Palette] [4] [Label] <FOH Blue> [Enter]**

Notice that when you recorded the color palette, all of the color data for channels 1 through 11 is displayed in live with the reference "CP 4". Because **[Record]** was used, it stored all of the color parameters for those channels.



**Note:** *[Record]* will store the entire parameter category into a palette. *[Record Only]* stores just the values you have adjusted manually to the target palette. See [Storing Palettes with \[Record Only\] \(on the facing page\)](#).

When a palette is created, the channels and the parameters involved in the record action are automatically set to the palette reference ("CP 4" in this instance). To view the absolute data for those channels, press and hold the **[Data]** key.

The following methods can be used to store palettes using **[Record]**:

- **[Record] {Color Palette 1}** - records all color parameter data to color palette 1 and shows it as the first color palette direct select. See [Storing Palettes to Direct Selects \(on the facing page\)](#) for more information.
- **[Record] [Focus Palette] [2] [Label] <name> [Enter]** - records focus parameter data for all channels not at their default state and adds a label to focus palette 2.
- **[Record] {Color Palette} [Next] [Enter]** - records data to the next sequential color palette number.

## Selective Storing Palettes with [Record]

Palettes can also be created using selective storing, which allows you to specify only the channels and or parameters that you want to store.

The following examples illustrate various methods of selectively storing palettes using **[Record]**:

- **[1] [Thru] [3] [Record] [Intensity Palette] [2] [Label] <name> [Enter]** - records the intensity data for selected channels 1 through 3 and adds a label to intensity palette 2.
- **[Group] [2] [Record] {Beam Palette} [Next] [Enter]** - records the beam parameter data for Group 2 to the next sequential beam palette number.
- **[-] [9] [Record] [Focus Palette] [5] [Enter]** - stores the focus data to focus palette 5, excluding the group or channels specified.
- **[1] [Thru] [9] {Iris} {Zoom} [Record] [Beam Palette] [5] [Enter]** - stores all zoom and iris data for channels 1 through 9 to beam palette 5.
- **[-] [5] [Record] [Beam Palette] [Next] [Label] <name> [Enter]** - stores to the next sequential beam palette, withholding the group or channels specified and adds a label.



**Note:** When using a selective store, you must specify the channel list to be included or excluded, identified by the **[+]** **[-]** modifier, as part of the **[Record]** command. Otherwise all channels with appropriate non-default data will be stored in the new palette.

---



**Note:** Selective storing is useful when you are doing a “one-time” selective store action. If you are recording a series of palettes with only specific parameters, it will save you time to set a record filter (see [Using Filters with Palettes \(on the next page\)](#)).

---

## Storing Palettes with [Record Only]

**[Record Only]** is a selective record process that stores **only manual parameter data**. When used to record palettes, only the manual parameter data for channels will be stored in the palette. As with record, filters can further restrict stored data if they are enabled when using **[Record Only]**. See [Storing Palettes Live \(on page 225\)](#) for more information.

---



**Note:** If you use **[Record Only]** to record to an existing palette, the data will be added to that palette. The original palette will not be completely overwritten. Only manual changes will be stored to the palette.

---



**Note:** It is possible to **[Update]** to add specific changes to the record target. See [Update \(on page 230\)](#) for more information.

---

The following methods can be used to selectively store manual parameter data to palettes using **[Record Only]**:

- **[Record Only] [Color Palette] [2] [Enter]**- records only the manual color parameter data to color palette 2.
- **[Record Only] [Beam Palette] [5] [Label] <name> [Enter]** - records manual beam parameter data for all channels and adds a label to beam palette 5.
- **[-] [9] [Record Only] [Color Palette] [Next] [Label] <name> [Enter]** - stores manual data to the next sequential color palette, withholding the group or channels specified and adds a label.
- **[select channels] [Record Only] [Focus Palette] [2] [Enter]** - stores focus palette 2, but only includes the manual data for the specified channels and parameters.
- **[1] [Thru] [9] {Iris} {Zoom} [Record Only] [Beam Palette] [5]** - stores only manual zoom and iris data for channels 1 through 9 to beam palette 5.

## Storing Palettes to Direct Selects

You can store palettes efficiently using the direct selects. Rather than using the **[...Palette]** hard key and the numeric keypad to specify a palette number, you can simply touch the desired direct select for that palette from the touchscreen.

### Example:

If you want to store color data to color palette 4, press:

- [Record]

and then press the button in the bank of color palette direct selects that is labeled in the lower right corner with a light gray "4".

- {Color Palette Direct Select Button 4}

"Color Palette 4" will appear in the direct select, indicating a successful store.

For more information on direct select mapping, see [Using Direct Selects \(on page 68\)](#).

## Using Filters with Palettes

Filters can be used to modify what data is stored to a palette by a record action. The parameters that are active or filtered allow those parameters to be stored to record targets.

To filter a parameter:

1. Press the {Filter} button in the CIA. The {Filter} button will flash.
2. Press the touchbutton for the parameter you wish to store.
3. Press the {Filter} button to release. "Filter On" appears next to the parameter category button.

To determine which parameter is filtered in the category:

1. Press the {Filter} button. All actively filtered parameters are highlighted in gray. You may need to press the arrow softkey for that parameter category to page additional parameters in the category.

Filters are a toggle state. To remove filters, press {Filter} and then press the highlighted parameter buttons in the CIA to deactivate the filters, or use {Clear Filters}.

For more information on filters, see [About Filters \(on page 284\)](#).

## Recalling Palettes

Palettes may be recalled from the control keypad or from direct selects.

When palettes are recalled, all data is manual and will display in red. Recalled palettes are applied only to selected channels, therefore you must select channels before recalling a palette. If a selected channel or parameter has no stored value in the recalled palette, it remains in its current state. Palettes on direct selects will be highlighted if they are applicable for the current channel selection.

You can select all the channels included in a palette by pressing [Group] [Palette] [x] [Enter]. You can also recall an entire palette by pressing [Recall From] [Palette] [x] [Enter].



**Note:** If enabled in Setup, you can double click on a palette direct select button to quickly recall from the selected palette and put its content on stage. See [Displays \(on page 164\)](#) for additional information.

Recalled palettes will appear as manual data for the specified channels. That data will appear as abbreviations of the palette type (IP3 = Intensity Palette 3, FP8 = Focus Palette 8, and so on), or as the palette label if defined/enabled in the displays settings in Setup (see [Show Reference Labels \(on page 164\)](#)). To see the numeric values behind any palette (or other referenced value), press and hold the [Data] key. To see the palette number behind the label, press [About] + [Label].



When palettes are recalled, channels with stored data in the palette will follow that data according to manual time settings. A manual time master fader can also affect the timing. See [Manual Time Master \(on page 83\)](#) for more information.

Palettes may also be recalled using a time specified using **[Sneak] [Time]**. For examples on using **[Sneak] [Time]**, see [Sneak \(on page 197\)](#)

You may also use groups to recall palettes. For example:

- **[Group] [1] [1] [Beam Palette] [5] [Enter]**
- **[Group] [5] {Color Palette 6}**

Palettes may also be recalled from the direct selects which automatically terminates the command line. To recall only specific parameters of a palette, select channels and the required parameters (or those not required, using the **[-]** key) in the command line.

The following are methods that can be used to recall palettes.

- **[selected channels] {direct select}** - recalls the associated (IFCB) palette data for the selected channels.
- **[selected channels] [Palette] [n] [Enter]** - recalls the associated IFCB palette for selected channels.
- **[Channel List] {edge} [Beam Palette] [n] [Enter]** - recalls only the edge data from the specified beam palette for the selected channels.
- **[Group] [n] [Palette] [z] [Enter]** - recalls all of the data in the palette and applies it to the selected group.
- **[Intensity Palette] [y] [At] [/] [z] [Enter]** - recalls the intensity palette for selected channels and sets all recalled intensity values to a proportioned level of their recorded states.



**Note:** *The above example breaks the referenced link to the intensity palette. To maintain the link, the palette must be recalled without a modified intensity value. Calling back the intensity palette at full will also break this link.*

---

When recalling palettes, only channels that are selected at the point of recall will be affected by the palette recall. The data recalled from a palette is referenced. To break the reference you may use **{Make Absolute}**.

- **[Channel List]{Edge} {Beam Palette} [n] {Make Abs} [Enter]** - recalls only the edge data from the specified beam palette for the selected channels and makes that absolute data.

## Palettes On Faders

Palettes can be mapped to faders. See [Presets and Palettes Fader Properties \(on page 244\)](#) for more information.

Presets and palettes can be used to create a temporary list of content that can be played back on a fader. See [Temporary Fader Mapping \(on page 247\)](#) for more information.

## Editing Palettes Live

If a palette is already recorded, **[Record]** replaces all existing data, unless channels have been excluded. **[Record Only]** is a selective store, therefore it adds data. Recording over a previously existing palette requires a confirmation, if confirmations are enabled in Setup. See [Record Defaults \(on page 159\)](#) It is also possible to **[Update]** to add manual changes to the record target.

## Rerecord

Rerecording follows the conventions illustrated in the **[Record]** and **[Record Only]** sections detailed earlier in this chapter. The only exception is that a confirmation is required to record over an existing palette.

There are two different methods for rerecording:

- **[Record] [Palette] [5] [Enter] [Enter]** - overwrites the content completely.
- **[Channel List] [Record] [Palette] [5] [Enter] [Enter]**- merges the data.

## Update

Live changes can be updated to both active and inactive palettes. When updating a parameter in an active palette, that parameter will no longer be absolute data, but will now be in the updated palette on stage.

The following illustrates how to update color palette 2 when no cues are active and you have recalled channels within that palette.

- **<channel list> [Update] [Color Palette] [2] [Enter]** - any manual changes for channels originally in the palette are updated in color palette 2.
- **[1] [Update] [Color Palette] [2] [Enter]** - adds channel 1's manual data to color palette 2.
- **[-] [3] [Update] {Color Palette 2}** - withholds manual changes for channel 3 from the update to Color Palette 2 using the direct selects.

If a channel or parameter does not have data in the palette being updated, it will not be added to that palette unless the user specifically requests it, by specifying the channel.

## Editing Palettes in Blind

All palettes can be viewed and edited in Blind. To open a palette in Blind, you can do any of the following:

- **[Blind] [Palette] [Enter]** - pressing this will display the first recorded palette of the selected type (Intensity, Focus, Color or Beam) in Blind or return to the last palette of this type viewed in blind.
- **[Blind] {Palette Select 3} or [Blind] [Palette] [3] [Enter]** - pressing this will display the specified palette in Blind.
- **[Palette] [Palette] {Edit}** - opens the list view of the palette type and then opens Blind palette. You can also use the tab number to open the list view. See [Editing Palettes in List View \(on page 232\)](#) for a list of tab numbers.



**CAUTION:** *When editing palettes in Blind, changes to palettes are automatic, therefore no update or record command is required.*

---

Palettes can be viewed and edited in blind in the table and spreadsheet views. In Blind, the following softkeys are available when editing palettes:

- [By Type](#)
- [Absolute](#)
- [Lock](#)
- [Cleanup](#)
- [Discrete](#)
- [Offset](#)
- [Make Null](#)
- [Make Absolute](#)

- [Replace With](#)
- [Query](#)

## Entering Blind Palette from Live

- **[Blind] [Palette] [Enter]** - pressing this will display the first recorded palette of the selected type (Intensity, Focus, Color or Beam) in blind or return to the last palette of this type viewed in blind.
- **[Blind] {Palette Select 3} or [Blind] [Palette] [3] [Enter]** - pressing this will display the specified palette in blind.
- **[Palette] [Palette] {Edit}** - opens the list view of the palette type and then opens blind palette.

## Viewing Palettes From Blind

While in any blind mode, when no channels are selected, you can enter a palette from the command line or direct selects. This will take you into blind channel mode for that palette.

- **[Color Palette] [n] [Enter]**

You may also step through the available palettes using **[Next]** and **[Last]**.

## Editing in Blind

The following are representative methods used for editing palettes in Blind:

- **[2] {Iris} [At] [Enter]** - removes the current parameter value from channel 2.
- **[1] {Iris} [5] [0] [Enter]** - selects channel 1 and sets iris value to 50.
- **[2] [Copy To] [5] [Enter]** - copies the information from channel 2 to channel 5.
- **[6] [Recall From] [Focus Palette] [1] [Enter]** - recalls the values for channel 6 from Focus Palette 1 but not the reference.

You may use the encoders to set Blind levels as well.

When editing in Blind, it is possible to remove an instruction from any palette by selecting the channel and parameter and pressing **[At] [Enter]** or **{Make Null} [Enter]**.

**[Recall From]**, **[Copy To]**, **Move To** (accessed by pressing **[Copy To] [Copy To]**), and **{Replace With}** may be used to create and edit palette data. See [About Advanced Manual Control \(on page 294\)](#).



**Note:** While editing palettes in blind, hitting **[Recall From] [Recall From]** will put **[Recall From] [Palette]** on the command line.

---

## Editing Palettes in Spreadsheet View

Blind Spreadsheet view shows a range of palettes along the Y axis and channels/channel parameters along the X axis. Viewing palettes in spreadsheet view is useful when you want to compare data between palettes. While in blind, press **[Format]** to access the spreadsheet. See [Spreadsheet \(Blind Only\) \(on page 51\)](#) for more information.

After selecting a palette, you may use the **[Next]** or **[Last]** keys to move through the list or you may select the exact palette from the keypad. You may also select a range of palettes to edit at once. You can make changes to the palette(s) by selecting channels and altering parameter values. In addition to normal editing functions, you may also use the following commands in this view: **[Copy To]**, **{Make Absolute}**, **{Make Null}**, **Move To** (accessed by pressing **[Copy To] [Copy To]**), and **{Replace With}**.

The following are representative methods used for editing palettes in blind spreadsheet:

- **[Color Palette] [1] [Thru] [9] [Enter]** - selects color palettes 1 through 9.
- **[1] {Scroller} {Make Null} [Enter]** - sets channel 1 scroller value null in the selected color palette(s).
- **[1] {Scroller} [4] [Enter]** - sets channel 1 scroller value to frame 4 in the selected color palette(s).

Here are some examples of the additional palette editing features available in spreadsheet view:

- **[palette type] [1] [Thru] [5] {Move To} <palette type> [9] [Enter]** - this will move palettes 1 through 5 to palettes 9 through 14 respectively. You do not have to supply the end value for Eos to perform the move.
- **[Beam Palette] [1] [Thru] [5] [Enter] {Iris} [5] [0] {Replace With} [2] [5] [Enter]** - for palettes 1 through 5, this command will replace any iris parameter values of 50 with values of 25.

## Editing Palettes in List View

When you press the specific Intensity, Focus, Color or Beam palette button twice, a list view for the associated palette type is opened in a new tab (or brings the list view into focus if already open). You can also open the list views from the home screen. See [Workspace Layout Menu \(on page 42\)](#) for more information.

You can also open the list views by using their tab numbers. Press and hold **[Tab]** and type the number to open.

- Intensity Palette - **[Tab] [2] [2]**
- Focus Palette - **[Tab] [2] [3]**
- Color Palette - **[Tab] [2] [4]**
- Beam Palette - **[Tab] [2] [5]**

Indicators for absolute (A), locked (L), and by type (T+) display to the right of the palette number.

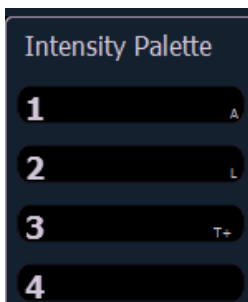

**Note:** In the by type channels column, any channel number with an asterisk indicates that the channel does not have any by type data stored to it.

From the list view, you can select a palette for editing, which changes focus to blind channel view, with the specified palette ready for editing. In addition, you can add palettes to your list and edit the labels for each palette in the list.

### Example:

In the list view, you can select palettes and relabel or move them.

- **[1] [5] [Label] <name> [Enter]**

While in the specific palette category list view, the **{Edit}** softkey is available for use. The **{Edit}** softkey opens a blind channel view of the selected palette and changes focus from the palette list. You can change the blind display to spreadsheet or table view by pressing the **[Format]** key.

#### To copy a specific palette to a new palette:

You can copy palettes within the list to another location in the list using **[Copy To]**.

- **<Color Palette> [2] [Copy To] [9] [Enter] [Enter]** - copies the contents of color palette 2 to color palette 9. Color palette 2 will remain in the list. The second **[Enter]** is not required if you have disabled confirmations in setup.

You can also use **[Copy To]** from presets to palettes.

#### To move a specific palette to a different location:

- **[1] {Move To} [3] [Enter]** - moves the contents and label of the specific palette 1 to palette 3. If palette 3 is already used, you will be asked to confirm that you want to overwrite the existing recorded palette. You can hit **[Copy To] [Copy To]** to access **{Move To}**.

You can also move data from a preset to a palette and vice versa. It is important to remember that when using the **{Move To}** command that data is removed from its current location and moved to its new location.

#### To edit any palette data from the List View:

- **[1] [5] {Edit} [Enter]** - selects palette number 15 and brings the blind display into focus, with palette 15 selected for editing. You can use the **[Next]** and **[Last]** buttons to access the other palettes, or select a new palette for editing from the keypad.

## Using By Type Palettes

### Storing a By Type Palette

If **{By Type}** is used when recording, the lowest number channel of each fixture type will be the default channel. Generally, when storing by type palettes, you will want only one channel of each fixture type in use. Any additional channels in that fixture type will be recorded with discrete data.

- **[1] [Thru] [5] [Record] [Int Palette] [1] {By Type} [Enter]** - Channels 1 through 5 are saved to Intensity Palette 1. Channels 1 through 5 are of the same fixture type. Channel 1 will be the default channel and channels 2 through 5 will be saved with discrete data.
- **[1] [Thru] [5] [Record] {Intensity Palette 1} [Enter]** - If a by type palette is recorded without using the **{By Type}** softkey and the default channel is included in the record, the default channel's level will change and all other changes will be discrete.
- **[1] [Thru] [5] [Record] {Intensity Palette 1} {Discrete} [Enter]** - If a default channel is included in a record where **{Discrete}** is used and another channel is tracking it, the default channel will be changed to having discrete data and the lowest numbered tracking channel will become the new default channel. All other channels in the record will also have discrete data.

### Editing By Type Palettes in Blind

In Blind, the default channel's levels will display in blue, discrete data for the other channels will display in white, and any channels that are using the default channel value will display in magenta.

- **[3] {By Type} [Enter]** - makes channel 3 the new default channel for that device type. If another channel for that type was the default channel, its data will now be discrete.

- **[1] [0] [Thru] [2] [0] {Discrete} [Enter]** - changes the levels for channels 10 through 20 to discrete. If any of those channels are default, the lowest numbered tracking channel will become the new default channel.
- **[5] [Thru] [8] [At] [Enter]** - removes the discrete data for channels 5 through 8. They will now use the default channel's values.
- **[Color Palette] [2] {Discrete} [Enter]** - changes all tracking and default channels to discrete.
- **[Intensity Palette] [5] {By Type} [Enter]** - makes the first channel of each device type a default channel.
- **[Beam Palette] [3] {Cleanup} [Enter]** - converts palettes created in earlier versions of Eos Family software to by type palettes. If by type channels exist in this palette, **{Cleanup}** will convert any discrete levels that match their by type channel's level to tracks.

**{Make Null}** can be used with by type palette when you wish to withhold a channel from responding to a by type palette recall. The data will still display but will be in gray with a "N". See [Using {Make Null} \(on page 297\)](#).

## Updating By Type Palettes

Pressing **{By Type}** after an **[Update]** command, with a channel tracking but no default channel included in the update, will cause the lowest numbered tracking channel's level to be updated into the default channel. The tracking channel will remain tracking. This means that when updating a default value in a by type palette, you don't need to know the default channel number.

When a default channel is included in an **[Update]** command without using **{By Type}** and another channel is tracking it, the default channel's data will be changed to discrete. The lowest numbered tracking channel will then become the new default channel. Any other updated channels will be made discrete.

## Removing Channels from a Palette

You can remove specific channels from a palette. This can be done from blind.

### Example:

Open the palette in blind:

- **[Blind] [Color Palette] [Enter]**

Select the palette you wish to edit:

- **[Color Palette] [5] [Enter]**

Remove channels by pressing:

- **[2] [+] [4] [+] [6] [Thru] [9] [At] [Enter]**

You may also remove a channel or parameter from a range of presets by pressing:

- **[Beam Palette] [1] [Thru] [5] [Enter] [6] [At] [Enter]**

You can remove channels from live by pressing:

- **[channel list] [Delete] [Color Palette] [2] [Enter]**

## Deleting Palettes

To delete color palette 1, press **[Delete] [Color Palette] [1] [Enter] [Enter]**. When palettes are deleted, any references in cues will be converted to absolute data.

# Chapter 11

## Storing and Using Presets

---

About Presets .....	236
Preset Options .....	236
Storing Presets Live .....	236
Recalling Presets .....	238
Effects In Presets .....	238
Editing Presets Live .....	239
Using the Preset List .....	239
Editing Presets in Blind .....	240
Using By Type Presets .....	242
Removing Channels From a Preset .....	243
Deleting Presets .....	243
Presets and Palettes Fader Properties .....	244

## About Presets

Presets are very similar to palettes in that they are collections of data for specific channels to facilitate cue creation. Presets, however, can collect **all** data for a given channel (intensity, focus, color, beam) rather than just one parameter category.

Eos supports up to 1,000 presets, which can be recorded as decimal (up to three places, 0.001) or whole number (up to 9,999.999). They can contain absolute data and/ or a mix of IFCB palettes. Presets can **not** refer to other presets.

Presets can be mapped to faders. Please see [Presets and Palettes Fader Properties \(on page 244\)](#) for more information.

## Preset Options

When recording presets, there are three softkey options:

- [{By Type} \(below\)](#)
- [{Absolute} \(below\)](#)
- [{Locked} \(below\)](#)

### {By Type}

By Type presets are created with 'default' channels which contain values that can be assigned to any other channel within the same fixture type. By Type presets can also contain discrete channel values.

By Type presets will display a 'T' in the lower corner of the direct selects and in the presets list. A '+' will display after the 'T' if there are channels stored with discrete data.

### {Absolute}

Absolute presets are presets that when recalled the data is displayed and treated like absolute data applied to a channel. The data is never referenced. An absolute preset will display with an 'A' in the lower corner of the direct selects and in the presets list.

### {Locked}

Locked presets are presets that are protected from being accidentally changed in Live.

A locked preset will display a "L" in the lower corner of the direct selects and in the presets list.

Locked presets can be updated by specifically calling the channels and the record target, [channel list] [Update] [record target] [Enter]. Using [Update] [Preset] [1] [Enter] would not work in Live for a locked preset. However locked presets are not protected in Blind.

## Storing Presets Live

Presets can be recorded live using the keypad and/ or the direct selects. Both [Record] and [Record Only] can be used to record presets, with or without filters. See [Storing Data with Record Filters \(on page 285\)](#) for more information.

[Record] will store all channels that are not at their home values, and it will record all information about those channels, including parameters that are still at default. Therefore presets can contain all of the same information as a cue, but they have no timing information or cue attributes (such as follow, delay, or cue overrides). When recorded or re-recorded, presets are automatically recalled on stage. Presets may be individually labeled.



## Storing Presets Using [Record]

The **[Record]** key will store all parameter data for channels with one or more parameters not at their home values, as modified by the filter settings in the CIA. If filters are used, only the parameters enabled by the filters are stored.

When you record data to a preset live, the channels involved in that preset will then actually be in that preset.

The following methods can be used to store presets using **[Record]**:

- **[Record] [Preset] [5] [Label] [name] [Enter]** - records all parameter data for all channels not at default and adds a label to preset 5.
- **[Record] [Preset] [Next] [Enter]** - records data to the next sequential preset number.
- **[-] [2] [Record] [Preset] [n] [Enter]** - stores the preset, withholding the group or channels specified.
- **[channel list] [Record] [Preset] [6] [Enter]** - stores the preset, but only the data for the channel list supplied.
- **[Record] {Preset 1}**- records the preset and shows it as the first preset direct select.
- **[channel list] {AllNPs} [Record] [Preset] [8] [Enter]** - records all non-intensity parameters for the selected channels to the preset.



**Note:** When using selective record, the user must specify the channel list to be included (or excluded as the case may be) as part of the **[Record]** command. Otherwise, all parameters of channels with non-home values will be stored in the preset.

---



**Note:** You may also use the filters and **{Make Null}** as additional tools to decide what data will be stored. For more information on these features see [Using {Make Null} \(on page 297\)](#) and [About Filters \(on page 284\)](#) .

---

When you re-record an existing Preset, a confirmation will be required, unless [confirmations](#) have been disabled in Setup.

## Storing Presets Using [Record Only]

**[Record Only]** is a selective record process that stores **only manual parameter data**. Therefore, when used to record presets, only manual data for channels will be stored in the preset. As with **[Record]**, filters and **{Make Null}** can be used to further modify what information is stored. See [Storing Data with Record Filters \(on page 285\)](#).

The following methods can be used to store presets using **[Record Only]**:

- **[Record Only] [Preset] [5] [Label] [name] [Enter]** - records **manual** parameter data for all channels and adds a label to preset 5.
- **[Record Only] [Preset] [Next] [Enter]** - records manual data to the next sequential preset number.
- **[-] [3] [Record Only] [Preset] [n] [Enter]** - stores the preset, withholding the group or channels specified.
- **[Channel list] [Record Only] [Preset] [6] [Enter]** - stores the preset, but only the manual data for the channel list supplied.
- **[Channel list] {Color} [Record Only] [Preset] [7] [Enter]** - stores only manual color data for the specified channels to the preset.

## Recalling Presets

Channels must be selected when recalling a preset. If a selected channel or parameter has no value in the preset, it will stay in its current position. If you want to recall all channels in a preset, you can press **[Recall From] [Preset] [x]**. Presets on direct selects will be highlighted if they are applicable for the current channel selection.



**Note:** If enabled in Setup, you can double click on a preset direct select button to quickly recall from the selected preset and put its content on stage. See [Displays \(on page 164\)](#) for additional information.

If you only want to recall certain parameters of the preset, select channels and enter the required parameters (or those not required, using the **[-]** key) in the command line (see command examples below).

When a preset is recalled, parameter changes will follow the manual timing defaults, if enabled. A manual time master fader can also affect the timing. See [Manual Time Master \(on page 83\)](#) for more information.

Presets may also be recalled using a time specified using **[Sneak] [Time]**. For examples on using **[Sneak] [Time]**, see [Sneak \(on page 197\)](#)

You may recall presets using any of the following methods:

- **{Preset direct select}** - recalls the associated preset data for selected channels.
- **[Preset] [2] [Enter]** - recalls preset 2 for selected channels.
- **[Channel List] [Preset] [2] [Enter]** - recalls the preset data for the channels in the selection list.
- **[Channel List] [Preset] [Enter]** - recalls the last selected preset's data for the channels in the selection list.
- **[Channel List] {Color} [Preset] [5] [Enter]** - recalls only the color data from the specified preset for the specified channels.
- **{Color} {Preset direct select}** - recalls just the color data from the specified preset for selected channels.
- **[Recall From] [Preset] [3] [At] [5] <0> [Enter]** - recalls all channels in preset 3, and sets all intensity values at 50%. The original intensity data is still linked to the preset. If the intensity change is desired, you must update the preset to maintain the change and the link. Storing the data to another record target would break the link and make the data absolute.
- **[Channel List] [Preset] [7] [Enter] [At] [/] [5] [Enter]** - recalls preset 7 for selected channels. Intensity values will be recalled at 50% of their recorded state. The intensity link is maintained. If the intensity change is desired the user either needs to update the preset to maintain the change and the link. Storing the data to another record target would break the link and make the data absolute.
- **[Recall From] [Preset] [9] [Enter]** - selects all channels with data stored in preset 9, and sets those channels to the values in preset 9.
- **[1] [Recall From] [Preset] [1] [At] [5] [0] [Enter]** - recalls the intensity of channel 1 from preset 1 at 50% of the stored value. If channel 1 was set to 50 in preset 1, it's recalled value would be 25.

## Effects In Presets

Effects can be stored in a preset, and those presets can be used to create submasters and cues. However, the effect's data is only copied to the submaster or cue, it is no longer referenced through the preset.



**Note:** If used with submasters and cues, the data is not referenced. So if changes are made to the effect in the preset, the effect saved to the submasters and cues will remain unchanged.

The preset list display has a column for effects.

For more information, see [Recording an Effect to a Preset \(on page 344\)](#).

## Editing Presets Live

There are two ways to edit a preset in Live. You may rerecord the preset or you may use [Update].

### Rerecord

Rerecording follows the conventions of [Record] and [Record Only]. The only exception is that a confirmation is required to actually rerecord the preset.

Two different mode for rerecording:

- [Record] [Preset] [5] [Enter] [Enter] - overwrites the content completely.
- [Channel List] [Record] [Preset] [5] [Enter] [Enter] - merges the data.

### Updating Presets

[Update] is used to record parameter modifications back to a preset. When updating, you must specify the preset to be updated. You may do this using the keypad or the direct selects.

For the purposes of the following descriptions, assume that there are no active cues on stage. Updating referenced values while cues are active is covered in [Modifying Cues Live \(on page 266\)](#).

#### Example:

To update a preset, first recall the preset for any channels you wish to edit.

- [1] [Thru] [5] [Preset] [1] [Enter]

-or-

- [Recall From] [Preset] [1] [Enter]

Make required changes to the desired parameters using the keypad or encoders. Once you have achieve the desired look, update the preset.

- [Update] [Preset] [1] [Enter]

-or-

- [Update] {Preset 1}

When updating a preset, only channels that are already in the preset will be updated. You need to select channels or parameters to force new data into a preset when using [Update].

## Using the Preset List

The preset list displays all recorded presets. The Preset List only allows you to change attributes; no editing can be done directly in list view.

### Opening the Preset List

Press [Preset] twice to open the list view. You can also open the list view from the home screen or by using [Tab] + [2][6]. See [Workspace Layout Menu \(on page 42\)](#) for more information.

Pressing the **{Edit}** softkey takes you to the blind view of the selected preset, in the last format you used in blind. This will allow you to edit the preset. You can change the blind display to spreadsheet or table view by pressing the **[Format]** key.

You can navigate the preset list using **[Next]** and **[Last]**.

Indicators for absolute (A), locked (L), and by type (T+) display to the right of the preset number.



**Note:** In the by type channels column, any channel number with an asterisk indicates that the channel does not have any by type data stored to it.

## Copy To

You can copy presets within the list to another location in the list using **[Copy To]**.

- **<Preset> [2] [Copy To] [9] [Enter] [Enter]** - copies the contents of preset 2 to preset 9. Preset 2 will remain in the list. The second **[Enter]** is not required if you have disabled confirmations in setup.

You can also use **[Copy To]** from palettes to presets.

## Move To

You can move presets within the preset list using **Move To**, which is accessed by pressing the **[Copy To]** button twice.

- **<Preset> [3] {Copy To} {Copy To} [8] [Enter] [Enter]** - moves preset 3 to preset 8. Preset 3 will be removed from the list. The second **[Enter]** is not required if you have disabled confirmations in setup.
- **<Preset> [1] [Thru] [5] {Copy To} {Copy To} [6] [Enter] [Enter]** - moves presets 1 through 5 to presets 6 through 10.

You can also move data from a palette to a preset and vice versa. It is important to remember that when using the **Move To** command that data is removed from its current location and moved to its new location.

## Editing Presets in Blind

All presets can be viewed and edited in blind. To open a preset in blind, you can do any of the following:

- Press **[Blind] {Preset x}** - opens to the specific preset.
- Press **[Tab] & [2][6]** - opens the preset list.
- Press **[Preset] [Preset]** and then **{Edit}** when a preset is selected in the list.



**CAUTION:** When editing presets in Blind, changes to presets are automatically stored. Therefore no update or record command is required.

---

You can change the blind display to spreadsheet or table view by pressing the **[Format]** key. In blind, the following softkeys are available when editing presets:

- *{By Type}* (on page 236)
- *{Absolute}* (on page 236)
- *{Locked}* (on page 236)
- Cleanup (*Using By Type Presets (on the next page)*)
- Discrete (*Using By Type Presets (on the next page)*)
- *Offset* (on page 172)
- Make Null (*Editing in Table View (below)*)
- Make Absolute (*Editing in Table View (below)*)
- Replace With (*Editing in Table View (below)*)
- Query (*Using [Query] (on page 300)*) (Element 2)

## Editing in Table View

Table view shows the data for one preset at a time in a table. Channels are displayed on the Y axis and parameters are shown along the X axis. Viewing presets in the table is useful if you want to see data for numerous channels in one specific preset.

To change which preset you are viewing you may use the **[Next]** or **[Last]** keys or you may select the exact preset from the keypad or direct selects. You can make changes to the preset by selecting channels and altering parameter values. In addition to normal editing functions, you may also use the following commands in this view: **[Copy To]**, **[Recall From]**, **{Make Absolute}**, **{Make Null}**, **{Move To}**, and **{Replace With}**.

Here are some examples of the additional preset editing features you have while editing in table view:

- [select channels or parameters] **{Make Abs}** - changes the data for any palette references within the preset into absolute data that no longer references another record target.
- [select channels or parameters] **{Make Null}** - removes the data for the specified channel or parameter from the preset.
- [select channels or parameters] **[At] [Enter]** - removes the data for the specified channel or parameter from the preset.
- **[Preset] [5] {Move To} [Preset] [9] [Enter]** - this will move the contents of preset 5 to preset 9. Preset 9 will be created and preset 5 will be deleted.
- **[Preset] [1] [Copy To] <Preset> [5] [Enter]** - this will copy the contents of preset 1 to preset 5. You may also copy ranges of presets to new locations.
- **[1][Recall From][Preset][1][Enter]** - will recall the contents for channel 1 in preset 1.



**Note:** While editing presets in blind, hitting **[Recall From] [Recall From]** will put **[Recall From] [Preset]** on the command line.

---

## Editing in Spreadsheet View

Spreadsheet view shows a range of presets along the Y axis and channels/channel parameters along the X axis. Viewing presets in spreadsheet view is useful when you want to compare data between presets.

You may select a preset from the spreadsheet using the **[Next]** or **[Last]** keys to move through the list or you may select the exact preset from the keypad. You may also select a range of presets to edit at once. You can make changes to the preset(s) by selecting channels and altering parameter values.

In addition to the examples given in [table view](#), here are some examples of the additional preset editing features you have while editing in spreadsheet view:

- **[Preset] [1] [Thru] [5] {Move To} <Preset> [9] [Enter]** - this will move presets 1 through 5 to presets 9 through 14 respectively. You do not have to supply the end value for Eos to perform the move. If presets 9 through 14 already exist you will be asked to confirm this move.
- **[Preset] [1] [Thru] [5] [Enter] {Iris} [5] [0] {Replace With} [2] [5] [Enter]** - for presets 1 through 5, this command will replace any iris parameter values of 50 with values of 25. Range editing using **{Replace With}** is easiest done in spreadsheet view, but can be done in any Blind mode.

## Using By Type Presets

### Storing a By Type Preset

If **{By Type}** is used when recording, the lowest number channel of each fixture type will be the default channel. Generally, when storing by type presets, you will want only one channel of each fixture type in use. Any additional channels in that fixture type will be recorded with discrete data.

- **[1] [Thru] [6] [Record] [Preset] [1] {By Type} [Enter]** - Channels 1 through 6 are saved to Preset 1. Channels 1 through 6 are of the same fixture type. Channel 1 will be the default channel, and channels 2 through 6 will be saved with discrete data.
- **[1] [Thru] [6] [Record] [Preset] [1] [Enter]** - If a by type preset is rerecorded without using the **{By Type}** softkey and the default channel is included in the record, the default channel's level will change and all other changes will be discrete.
- **[1] [Thru] [5] [Record] {Preset 1} {Discrete} [Enter]** - If a default channel is included in a record where **{Discrete}** is used and another channel is tracking it, the default channel will be changed to having discrete data and the lowest numbered tracking channel will become the new default channel. All other channels in the record will also have discrete data.

### Editing By Type Presets in Blind

In Blind, the default channel's levels will display in blue, discrete data for the other channels will display in white, and any channels that are using the default channel value will display in magenta.

Ch	Intens	Intensity MSpeed	Pan	Tilt	Position MSpeed	Cyan	Magenta	Yellow	Color Select	Color Wheel Mode
71	FL	0	0	0	0	67	56	34	F1-	25
72	FL	0	0	0	0	67	56	61	F1-	25
73	FL	0	0	0	0	67	56	34	F1-	25
74	FL	0	0	0	0	67	56	34	F1-	25
75	FL	0	0	0	0	67	56	34	F1-	25
76	FL	0	0	0	0	67	56	34	F1-	25

Softkeys available for editing presets in blind are **{By Type}**, **{Discrete}**, and **{Cleanup}**.

- **[3] {By Type} [Enter]** - makes channel 3 the new default channel for that device type. If another channel for that type was the default channel, its data will now be discrete.

- **[1] [0] [Thru] [2] [0] {Discrete} [Enter]** - changes the levels for channels 10 through 20 to discrete. If any of those channels are default, the lowest numbered tracking channel will become the new default channel.
- **[5] [Thru] [8] [At] [Enter]** - removes the discrete data for channels 5 through 8. They will now use the default channel's values.
- **[Preset] [2] {Discrete} [Enter]** - changes all tracking and default channels to discrete.
- **[Preset] [5] {By Type} [Enter]** - makes the first channel of each device type a default channel.
- **[Preset] [3] {Cleanup} [Enter]** - converts presets created in earlier versions of Eos Family software to by type presets. This command will use the first channel of each type as the default, and allow other channels of the same type to use that value upon recall.

**{Make Null}** can be used with by type preset when you wish to withhold a channel from responding to a by type preset recall. The data will still display but will be in gray with a "N".

## Updating By Type Presets

Pressing **{By Type}** after an **[Update]** command, with a channel tracking but no default channel included in the update, will cause the lowest numbered tracking channel's level to be updated into the default channel. The tracking channel will remain tracking. This means that when updating a default value in a by type preset, you don't need to know the default channel number.

When a default channel is included in an **[Update]** command without using **{By Type}** and another channel is tracking it, the default channel's data will be changed to discrete. The lowest numbered tracking channel will then become the new default channel. Any other updated channels will be made discrete.

## Removing Channels From a Preset

You can remove specific channels from a preset. This can be done from blind.

### Example:

Open the preset in blind:

- **[Blind] [Preset] [Enter]**

Select the preset you wish to edit:

- **[Preset] [5] [Enter]**

Remove channels by pressing:

- **[2] [+] [4] [+] [6] [Thru] [9] [At] [Enter]**

Or you can remove a specific channel parameter from the preset by pressing:

- **[5] [+] [7] {Color} [At] [Enter]**

You may also remove a channel/ parameter from a range of presets by pressing:

- **[Preset] [1] [Thru] [5] [Enter] [1] {Color} [At] [Enter]**

You can remove channels from live by pressing:

- **[channel list] [Delete] [Preset] [2] [Enter]**

## Deleting Presets

You may delete presets in the following ways:

- **[Delete] [Preset] [1] [Enter]**
- **[Delete] [Preset] [1] [Thru] [5] [Enter]**

Presets can be deleted from any screen, at any time. A confirmation is required to delete, unless confirmations have been disabled in Setup. See [Record Defaults \(on page 159\)](#)

## Presets and Palettes Fader Properties

Presets and Palettes can be mapped to faders by using the fader configuration display. For information on how to use the fader configuration display to map faders, see [Fader Configuration \(on page 78\)](#)

The fader configuration display is found on Tab 36 .The [Fader List \(on page 80\)](#), which shows all of the faders and their assignments, can be found in Tab 35.

Click or tap the second row of the fader page to access this properties display.

The following options are available when a fader is configured as a preset or palette fader:



### Mode

You may define your fader as additive (contributes to the live output), inhibitive (limits live output) or an effect fader (presets only).

### Master

A fader can be assigned as a Master. When it is a master, its behavior as a Proportional Master or Intensity Master (I-Master) is drawn from this setting.

### HTP

Intensity playback behavior can be set to HTP (highest takes precedence) or LTP (latest takes precedence).

### Restore

Faders can be placed into restore modes of minimum or background, which is the default. When a fader is in the restore to background mode, the restore column of the fader list display will be blank. When in minimum mode, 'Min' will display in the restore column.

The restore mode of background means that when the fader is returned to zero, control will be restored to the background value, such as another fader or a cue.

The restore mode of minimum means that when the fader is faded down, control does not go to the previous background state but to the parameters' minimum value.



## Priority

The Independent setting for faders has been changed to priority. There are 10 levels of priority for faders. 1 is the lowest and 10 is the highest. faders can still be shielded, which means that their content is automatically made exclusive and can't be controlled by anything other than that fader and park, including by manual control. Shielded has a higher priority than 10.

## Background

Faders can have their background states disabled. Background states are enabled by default. When enabled, the content of the fader will act as a background or previous state for other cues and faders.

## Background Priority

Background can have a priority assigned to it.

In previous software releases, when content was released, it always returned to the last fader that owned it. Background priority releases to the highest priority content that previously had ownership, provided that content has not be turned off or released.

There are 10 levels of background priority for faders. 1 is the lowest and 10 is the highest. When LTP content is released to background, it will go to the background state with the highest available priority.

## Up Time

This is the time for the fader to fade from its home position to its target position (0 to Full if additive, Full to 0 if inhibitive). The default time is 0.

## Dwell Time

This is the time the fader look will hold before starting the downfade. This can be set to a specified time, or to "Hold" or "Manual". "Hold" time maintains the fader values until the bump is pressed a second time. "Manual" time applies the fader values only as long as the bump is held. The default is "Manual".

## Down Time

This is the time for the content on a fader to fade from its target position to its home position. The default time is 0.

## Stomp Mode

Stomp happens when all the content owned by a fader is now being controlled by other targets. The fader is being removed from the background, and once that happens, it would not be eligible to fade back. You can assign behavior that will happen when a fader is stomped.

- **Off When Stomped** - puts the content into an off state, the same behavior encountered when pressing **[Off] + [Load]**.
- **Unload When Stomped** - unloads the fader.
- **Nothing When Stomped** - no action happens to the fader.
- **Release When Stomped** - This function behaves the same as Off When Stomped.

## Unmark at 0%

When this option is on, marked content controlled by the fader will automatically be released when the fader reaches 0%. When the bump button is next pressed, the fader will fire. If this option is off, you would need to first press the bump button to reset the fader before pressing the

bump again to fire it.



**Note:** This option is for faders that are set to Intensity Master.

## Exclusions

Those exclusions include:

- **Exclude From Record** - output is not recorded into any other record target.
- **Exclude From Grandmaster** - content cannot be mastered by a grandmaster.
- **Exclude From Inhibitive Sub** - content cannot be mastered by an inhibitive submaster
- **Exclude From Solo** - content will ignore solo. See [Fader and Button Configuration \(on page 281\)](#) for more information on solo.

## Channel and Parameter Filters

Channel and Parameter Filters can be used to allow only specified data to be played back. These are playback filters, and do not impact how data is recorded.

Tap or click on **{Chan Filter}** to assign channels or groups. Tap or click on **{Param Filter}** to open a list of available parameters that you can filter.

When a filter has been applied, an indicator will display in the fader ribbon. C will display for channel filter, and F is for parameter filter.

Press the red [X] to clear the channel or parameter filters listed.

## Fader and Button Configuration

Click or tap on the virtual buttons or fader to see a list of available configuration options.

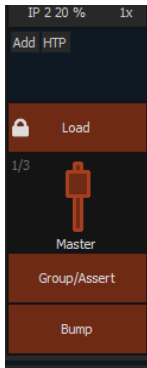

## Button Options

The following options are available for fader buttons:

- **Bump** - plays back the content at 100% of the recorded level. It will continue to do so until released, unless the fader has a time assigned or the **{Hold}** property set.
- **Group/ Assert** - selects all the channels associated with the fader, if the fader is inactive. If active, the contents of the fader will be asserted.
- **Assert** - regains control of all of the channels associated with the fader.
- **Group Select** - selects the channels stored in the fader. This is the same as **[Group] [Sub] [n]**.
- **Freeze** - halts all effect activity on the fader.

- **Off** - removes the content and if the fader is set to Master, the fader will remain where it currently is.
- **Release** - removes the content and if the fader is set to Master, the fader will reset to 0.
- **Start Stop Effect** - starts the effect while ignoring dwell times. Will stop effects if any are running.
- **Button Disabled** - no action is assigned to the button.
- **Solo** - suppresses any intensity values not provided by the associated content while the solo button is held down. When the button is released, intensity values are restored. Priority and HTP are ignored. Shielded, park and pixel mapping outputs are not affected by the solo button.
- **Back** - fades to the previous cue when fader is assigned to a cue list.
- **Macro** - allows you to assign a macro as a button action.

## Fader Options

The following options are available for a fader:

- **Master** - fader will be a proportional master, a manual master, or an intensity master.
- **Effect Rate** - fader centers to home. It controls the rate of any running effects (same behavior as using rate via the Effect Status Display). The adjusted setting from this control cannot be stored.
- **Effect Size** - similar to Effect Rate but for effect size.
- **Rate Master** - homes to center. It adjusts the cue rate, just like rate and load.
- **Fader Disabled** - no action is assigned to the fade.
- **Master Only** - fader is used to set a level for content to fade to. The slider can be used to live adjust levels when the fader has been activated via the bump button. See [Master Only \(on page 84\)](#) for more information.
- **Effect Master** - masters the entry/exit mode of the effects (size, rate or both).
- **Levels Only** - masters the levels without mastering the effect.

## Temporary Fader Mapping

Presets and palettes can be used to create a temporary list of content that can be played back on a fader.



**Note:** *This list is not recorded. If the fader is unloaded, the list cannot be recalled.*

---

To create a list, press the **[Load]** button of an unmapped fader. You can then select presets or palettes to add to your list either by the command line or from the direct selects.

- **[Load] {DS 1} {DS 2} {DS 2} [Enter]**
- **{Fader} [1][0] [Preset] [1] [Preset] [2] [Preset] [3] [Enter]**

Once mapped, the fader will default to Master Only mode. See [Master Only \(on page 84\)](#) for more information.

The list will use the timing assigned to the fader.

A fader with temporary mapping will have the cue list options for Back From First and Go From Last. These are Cue List Properties, please see [Cue List Properties \(on page 278\)](#)

The list of targets will display in the Fader Configuration List (Tab 36), in the Fader List (Tab 35), and in the Fader Ribbon.



# Chapter 12

## Working with a Single Cue List

---

About Single Cue List .....	250
Basic Cueing .....	250
Recording Cues in Live .....	250
Using [Cue Only / Track] .....	252
Selective Storing Cues in Live .....	253
Timing .....	254
Assigning Cue Attributes .....	257
Flags .....	263
Using External Links .....	265
Modifying Cues Live .....	266
[Update] .....	267
Recording and Editing Cues from Blind .....	271
Deleting Cues .....	274
Using The Cue List Index .....	275

## About Single Cue List

A cue is a record target comprised of channels with associated parameter data, discrete (channel/parameter level) timing, cue timing, and cue attributes (such as preheat, follow or hang instructions).

When cues are created, they are stored in a cue list.

By default, recording cues will result in a single cue list, identified as cue list 1.

While other cue lists can be recorded in Eos, this section deals primarily with working in a single cue list.

Element 2 does not have multiple cue lists.

For more information on multiple cue lists, see [About Working With Multiple Cue Lists \(on page 288\)](#)

## Basic Cueing

In Setup, you determine if Eos will operate in a Cue Only or Tracking mode. See [Tracking vs. Cue Only \(on page 6\)](#) By default, the system is set to tracking, therefore this section primarily addresses working in tracking mode. The current mode is displayed in the upper left corner of the live/blind display. It is important to know which mode you are working in, as it impacts how cues are edited.

- If your console is set in Track mode (default), changes move forward through the cue list until a block or a move instruction is encountered.
- If your console is set in Cue Only mode, changes to cues have no impact on subsequent cue data.

## Cue Numbering

Cues can be numbered from 0.001 - 9999.999. You can have up to 10,000 cues.

Eos provides you with multiple ways to number your cues. The most common methods are listed below:

- After pressing record, enter a cue number which can be a whole number (1) or a decimal number (1.1).
- After pressing record, rather than entering a cue number you may press **[Next]**, which will automatically number the cue with the next sequential number in the same cue list. For example, the current cue is numbered cue 1.1, pressing **[Record] [Next]** will automatically number the new cue 1.2.
- When recording decimal cues, it is not necessary to specify the leading cue number if a cue has already been recorded. For example, if the current cue is numbered 5, when you enter the next record command, you can just enter **[.] [5]** to record cue 5.5.
- Whole numbered cue - **[Next]** increments the next whole numbered cue.
- Tenths numbered cue (.1) - **[Next]** increments in tenths.
- Hundredths (.01) numbered cue - **[Next]** increments in hundredths.
- Thousandths (.001) numbered cue - **[Next]** increments in thousandths.

## Recording Cues in Live

When using **[Record]**, all parameters of any fixtures that have non-home values, either from manual control, other cues, or submaster playback are stored in the target cue.

Channels that have all home values, meaning they have never been changed, are not included in the record action, unless you specifically select the channel and press **{Make Manual}**. See [Using {Make Manual} \(on page 298\)](#) for more information.

Possible exclusions are parameters categories or individual channel parameters withheld by use of filters (see [About Filters \(on page 284\)](#)). You can also select individual parameters of individual channels (such as Cyan and Iris) and place them in a null state using the **{Make Null}** button if the values are not needed in the cue you are recording. See [Using {Make Null} \(on page 297\)](#) for more information.

You could also use **{Release}**. Release is an extension of the **{Make Null}** command in Blind. When Release is used, it behaves like Make Null, but it also releases the channel and parameter data to its background state, if one is available, or fades out the intensity instead.

Release can be used to mask instructions in a cue after it has already been stored. The data is not removed from the cue. See [Release \(on page 298\)](#) for more information.

Eos is a tracking console, meaning once something is recorded into the cue list, the cue list will always contain information about that channel/ parameter unless it is nulled, by using the **{Make Null}** command, released by using the **{Release}** command, or filtered using the parameter filters.

When cues are recorded they are automatically played back and manual values are released, unless auto playback on record has been disabled in setup. See [Auto Playback \(on page 159\)](#). Upon playback, displayed parameter levels will be color coded for clarification of the record action:

- **Blue** - intensity has increased from the previous cue or a non-intensity parameter has changed.
- **Green** - intensity level has decreased from the previous cue or a non-intensity parameter has marked.
- **Magenta** - level has tracked from a previous cue.
- **White** - level has been blocked (see [Block \(on page 263\)](#)).

## Using Record in Live

When the **[Record]** button is pressed the keypad defaults to cue mode; use of the **[Cue]** button is optional. The following are representative examples of recording cues in Live. Once the cue record has been specified, cue attributes such as timing can be combined and entered in any order you wish.

- **[Record] <Cue> [5] [Enter]** - records all parameters of any channels with non-default data into the specified cue number 5.
- **[Record] <Cue> [5] [Label] [name] [Enter]** - records the specified cue and provides an alphanumeric label.



**Note:** When using the console in tracking mode or when using track editing, it is important to understand the concept of Blocking. A cue containing a Block flag will stop edited levels from tracking through that cue. Blocks are often placed on the cue at the top of an act or scene, or anywhere you want to protect cues from levels that may track in from upstream cues. Block flags should also be set on cues that you want to have behave as blackouts (see [Block \(on page 263\)](#)).

---

## Using Record Only in Live

**[Record Only]** is similar to **[Record]** except that it selectively stores only manually set values, preventing unwanted levels (such as from a submaster or another cue list), from being recorded into the cue. Therefore, when used to record a cue, only the manual data for channels will be

stored in the cue. Any values in the previous cue that were unchanged will track into the new cue.

All of the same commands used for **[Record]** may also be used for **[Record Only]**.

- **[Record Only] <Cue> [Next] [Enter]** - stores only the manually set values into the next cue in the list.
- **[Record Only] [Cue] [3] [Enter]** - stores only the manually set data into cue 3.

As with **[Record]**, filters can further restrict stored data if deployed when using **[Record Only]**. See [About Filters \(on page 284\)](#)

## Record and Record Only [+]

[+] can be used to specify a range of cues when using **[Record]** and **[Record Only]**.



**Note:** If no cue number is entered before the [+], the current active cue will be used.

---

### Example:

To record only cues 5, 10, and 15:

- **[Record] <Cue> [5] [+] [1][0] [+] [1][5] <CueOnly/Track> [Enter]**

To update the current cue and cue 7:

- **[Record Only] [+] <Cue>[7] <CueOnly/Track> [Enter]**
- 

## Using [Cue Only / Track]



**Note:** For a more detailed summary of Cue Only and Tracking modes, please see [Tracking vs. Cue Only \(on page 6\)](#).

---

## In Track Mode

When you create a new cue, any channel parameter data from the previous cue is tracked into the new specified cue. Any changes in this new cue will also track forward into subsequent cues until a move instruction is encountered. The **[Q Only/Track]** key is an exception to this behavior. When you record a cue in the middle of an existing cue list, using the **[Q Only]** button will prohibit new information from tracking into the subsequent cue. When you rerecord or update a cue, the modifications will not track forward.



**Note:** In the following examples, the command **[Q Only]** indicates the same key hit of **[Q Only/Track]** which is a single button on the keypad. The system setting determines the actual context of the button depending on the mode in which the system is operating. For clarity, only the contextual function of the button is used in the examples.

---

### With system set to Track

- **[Record] <Cue> [5] [Q Only] [Enter]** - records cue 5. New values or changes will not track into the subsequent cue.
- **[-] [Color] [Record] <Cue> [5] [Q Only] [Enter]** - as above the recorded data will not track forward and all color data is excluded from the record operation.
- **[Record Only] <Cue> [5] [Q Only] [Enter]** - records all manual data, but doesn't allow it to track into subsequent cues.



- [-] [5] [Record] <Cue> [6] [Q Only] [Enter] - records the specified cue, except the contributions from channel 5. The stored data will not track forward in the list.

## In Cue Only Mode

When you create a new cue, any channel parameter data from the previous cue is tracked into the new cue. The [Q Only/Track] key can be used as an applied exception to the cue only/ track system setting.



**Note:** In the following examples, the command **[Track]** indicate the same key hit of **[Q Only/Track]** which is a single button on the keypad. The system setting determines the actual context of the button depending on the mode the system is operating. For clarity, only the contextual function of the button is used in the examples.

### With system set to Cue Only

- [Record] <Cue> [5] [Track] [Enter] - records cue 5. This data will track forward in the list until the next move instruction or block.
- [-] [5] [Color] [Record] <Cue> [6] [Track] [Enter] - records the specified cue, except the color data from channel 5. The data will track forward in the list until the next move instruction or block.
- [Record Only] <Cue> [2] [Thru] [7] [Track] [Enter] - stores all manual data. The stored data will be forced to track from cue 2 through 7 through any blocks or move instructions. After cue 7, values will continue to track until a move instruction or block is encountered.

## Selective Storing Cues in Live

Cues can also be modified using selective storing, which allows you to specify only the channels and or parameters that you want to store. When using a selective store, you must specify the channel list to be included or excluded, identified by [Thru], [+], [-], as part of the [Record] or [Record Only] command.

See [Using Selective Store \(below\)](#) for more information.

### Using Selective Store

You may use the [-] button to withhold information from a cue or use the [+] button to specify a particular channel/ parameter to be included in the record action. These actions are both selective stores.

For information on a selective store using filters see [Partial Filters \(on page 284\)](#).

Since Eos is a tracking console, any channels not included in the selective store, but that do have values in the previous cue will track into the recorded cue. This is true even when the desk is in Cue Only mode. To remove intensity values that would otherwise track when on a selective store, the rem dim command can be used. See [Remainder Dim \(on page 194\)](#).

### Using a Positive Selective Store

You may record only specified parameters into cues. If the cue has already been stored, this action adds the specified channel parameters to the existing cue data.

To record only specific channels into a new target cue:

- [1] [Thru] [5] [Record] <Cue> [4] [Enter] - records only channels 1 through 5 into cue 4.
- [channel list] [Record] <Cue> [5] [Rem Dim] [Enter] - stores the selected channels into the target cue. Any channels active in the previous cue that are not in the selected channel list will be set to zero in cue 5.

- [2] [Thru] [8] [Record Only] <Cue> [9] [Enter] - stores only the manually set data for channels 2 through 8 into the target cue 9.
- [Group] [2] [Record Only] [Cue] [5] [Enter] - stores only the manual data from group 2 into cue 5.

To record only specific parameters into a target cue:

- [1] [Thru] [5] {Focus} {Color} [Record] <Cue> [4] [Enter] - records the focus and color data for channels 1 through 5 into cue 4. Any other data on stage would not be stored in the target cue.
- [selected channels] {Color} [Record Only] <Cue> [4] [Enter] - stores only the color data for the selected channels into cue 4.

Using a selective store for a new record target will track in values from the previous cue that are not included in the record action.

Using a selective store for an already existing cue will modify the selected data only, leaving the rest of the cue untouched. This does not overwrite the whole cue.

### ***Using a Negative Selective Store***

It is possible to withhold data from a cue by using the [-] key as follows:

- [-] [Group] [3] [Thru] <Group> [6] [Record] <Cue> [9] [Enter] - records the specified cue, with the exception of any channels associated with groups 3 through 6.
- [-] [3] [Thru] [6] [Record] <Cue> [9] [Enter] - records the specified cue, with the exception of channels 3 through 6.
- [-] [Sub] [7] [Record] [Enter] - records the selected cue, without the input from submaster 7.
- [-] [Sub] [Record] [Enter] - as above, except withholds the contents of all submasters.
- - {Color} [Record] <Cue> [8] [Enter] - records cue 8 without any color data.

## **Timing**

Cue timing can be applied in a variety of ways. At a cue level, timing categories are provided for intensity up, intensity down, focus, color and beam transitions. Each of these times can have an associated delay. Timing can also be applied directly to a channel or a specific parameter. This is called discrete timing.

Time can be entered in minutes and seconds (example 10:15) with valid fade times from zero to 99:59 ( 99 minutes and 59 seconds), or seconds and tenths of seconds (example 1.3), or 100ths of seconds (example 1.35) with valid fade times from zero to 99.99. When no time is applied at a cue level, the defaults established in **Setup** are used. See [Cue Settings \(on page 151\)](#)

### Example:

You want the time for cue 1 to be 10 minutes and 15 seconds.

- [Cue] [1] [Time] [1][0][1][5] [Enter]

The command line will show the time as:

```
LIVE: Cue 1 : Cue 1 Time 10:15 ◆
```

If you want the time for cue 1 to be in seconds and tenths of a second, like 1.3 seconds, you will type using a decimal.

- [Cue] [1] [Time] [1][.][3] [Enter]

The command line will show the time as:

```
LIVE: Cue 1 : Cue 1 Time 0:01.3 ◆
```

## Setting Cue Level Timing

Unless you specify otherwise, Eos assigns default fade times to any cue you record. Default timing is designated in **Setup** ([Cue Settings \(on page 151\)](#)). Cue level timing can be applied when a cue is recorded or can be added or modified later.

Following are some examples of record commands with cue level timing:

- [Record] <Cue> [5] [Time] [9] [Enter] - puts a time of 9 seconds on all parameter timing categories.
- [Record] <Cue> [6] [Time] [3] [Time] [9] [Enter] -specifies the intensity up, focus, color, and beam times at 3 seconds and the down time at 9 seconds. The first instance of [Time] is used for intensity up fade (meaning intensity value is fading to a higher level than previously set) and the second instance of [Time] is used for intensity down fade time (intensity values fading to a lower level than previously set).
- [Record] <Cue> [2] [Time] [Enter] - resets time to default value defined in **Setup**.



**Note:** Unless FCB timing is specifically set, it always defaults to the up fade time value.

## Manual Timing at a Cue Level

It is possible to assign a time of manual, for manual parameter transition through the associated fader. See [Manual Timing Control \(on page 314\)](#) for more information. Manual times are assigned by using the {Manual} softkey that displays after [Time] is pressed when recording a cue.

- [Record] <Cue> [4] [Time] {Manual} [Enter] - applies a manual time. If the cue had previously been given split times, would apply a manual to the up fade, focus, color, and beam times. If the cue had a single time, all of the timing would be manual and controlled by the fader.
- [Record] <Cue> [4] [Time] [Time] {Manual} [Enter] - applies a manual intensity time to the down fade.
- [Record] <Cue> [4] {Color} [Time] {Manual} [Enter] - applies a manual time to any color data changes in cue 4.

## Non-intensity Parameter Category Timing

Timing can be also applied for Focus, Color and Beam parameter categories at a cue level. By default, FCB timing is the same as intensity upfade time. Once FCB timing is different than intensity upfade time, those times are no longer affected by intensity upfade changes.

When you apply a time to an individual parameter category and that category has no movement, the time is displayed in gray. The specified timing will remain in gray until that category is provided with a move instruction, at which point it the timing will display in white.

- **[Record] <Cue> [2] {Color} [Time] [7] [Enter]** - records cue 2 with a cue level color time of 7.
- **[Record] <Cue> [2] {Color} [Time] [Enter]** - resets the color time of cue 2 back to the default value.
- **[Record] <Cue> [2] [Time] [Time] [Time] [7] [Enter]** - records cue 2 with a cue level focus time of 7. In this example, each press of the **[Time]** key steps through each timing value (up time, down time, focus time, color time and beam time).
- **[Record] <Cue> [2] [Time] [7] [Enter]** - records cue 2 and puts a time of 7 on all parameter categories. This only works if FCB timing was previously untouched. If FCB timing had been changed, this syntax example would change just the upfade time to 7.



**Note:** *It is not necessary to rerecord a cue to alter stored timing data. You can simply redefine the time by specifying the cue and re-entering the time value(s).*

- **[Cue] [5] [Time] [8] [Enter]** - redefines the all category times to 8 seconds. This only works if FCB timing was previously untouched. If FCB timing had been changed, this syntax example would change just the upfade time to 8.
- **[Cue] [2] {Color} [Time] [5] [Enter]** - redefines color time to 5 seconds.
- **[Cue] [3] {Focus} [Time] [-] [2] [Enter]** - removes 2 seconds from the current time.
- **[Cue] [7] {Beam} [Time] [+] [3] [Enter]** - adds 3 seconds to the current time.

## [Time][/]

The **[/]** key can be used with **[Time]** to control the intensity upfade and downfade times, and delays.

- **[Cue] [1] [Time] [/] [5] [Enter]** - places a downfade time of 5 on the cue, while splitting the upfade, which preserves its current value.
- **[Cue] [2] [Time] [/] [Enter]** - removes the downfade time and makes the downfade match the upfade.
- **[Cue] [3] [Time] [4] [/] [Enter]** - sets the upfade time, and splits the downfade without splitting the FCB times.
- **[Cue] [5] [Time] [4] [/][3] [Enter]** - sets the upfade and the downfade times.
- **[Cue] [4] [Time] [2] [/] [/] [Enter]** - changes only the intensity upfade time and splits the downfade and FCB times preserving their current value.

## Discrete Channel and Parameter Timing

Rather than using cue times, timing can be applied directly at a parameter or channel level. This is referred to as discrete time.

Discrete timing can be applied to a specific channel or parameter. You must select the channels that you want to apply the time to, otherwise the system assumes you are addressing the selected cue.

Following are some examples of use:

- [channel list] {Color} [Time] [3] [Enter] - adds a time of 3 seconds to all of the color parameters of the channel list that have a move instruction.
- {Focus} [Time] [7] [Enter] - assigns a time of 7 seconds for the focus attribute of all selected channels.
- [Select Manual] {Beam} [Time] [7] [Enter] - selects channels with manual data and applies a time of 7 to any manual beam values.

Discrete delay times can also be placed on a channel parameter.

- [1] {Color} [Time] [4] [Delay] [3] [Enter] - places a time of 4 seconds and a delay of 3 seconds on all color parameters of channel 1.

The [+ ] and [- ] hardkeys can be used to increase or decrease discrete timing values.

- [channel list] [Time] [+ ] [3] [Enter] - increases the discrete timing values by 3 seconds.
- [channel list] [Delay] [- ] [1] [Enter] - decreases the discrete delay value by 1 second.

When timing has been applied to a channel parameter in live, a small red “t” will be displayed with the channel. This indicates the timing must be stored or updated to the required cue. When this is done, the “t” is displayed in blue. In the Playback Status Display, a “+” is displayed in the associated parameter category time field, indicating that not all of the parameters in the cue will use the cue timing.



[About] & [Time] can be held down to see the discrete delay /time information for channels in Live /Blind. Delay is displayed first, followed by the timing value.



**Note:** Any conditions placed on channel /parameter in live (such as discrete timing, asserts, blocks, etc) must be stored or updated to the cue.

---

## Discrete Time as a Percentage

Discrete times can be entered as a percentage of the cue time.

- [channel list] [Time] [/] [5] [Enter] sets the time to 50% of the cue time.
- [channel list] {Focus} [Time] [/] [7][5] [Enter] - sets the discrete focus timing to 75%.

## Assigning Cue Attributes

You can record cues with specific attributes to affect how cues behave when executed. Cue attributes include [Follow](#), [Hang](#), [Link](#), [Loop](#), [Delay Time](#), [Rate](#), [Curve](#), [Cue Notes](#), [Cue Labels](#), and [Scenes](#). Cue attributes can be entered when the cue is initially recorded, or they can be added or modified at a later date.

When [Cue] is pressed, the {Attributes} softkey will display. Press {Attributes} to access the following softkeys:

- {Rate}
- {Note}
- {Scene}
- {Curve}
- {Preheat}

- {AF/MF} (Allfade/ Move Fade)
- {Scene End}



**Note:** Preheat and Allfade are flags. Please see [Preheat \(on page 264\)](#) and [AllFade \(on page 264\)](#) for more information.



**Note:** On Element 2, only Preheat is available.

## Follow/ Hang

A follow automatically activates the next cue in the sequence when the follow time of the associated cue has elapsed. The follow time begins counting from the moment the cue is executed.

The hang time is also an auto-follow, but rather than counting from the moment the cue is executed, it is calculated from the completion of the cue. You can assign a negative value to a hang time, allowing a subsequent cue to overlap an active cue.

You can assign either a follow time or a hang time, but not both. Both features are accessed using the **[Shift] & [Delay]** keys on the console or the softkey **{Fw/Hg}**. **[Shift] & [Delay]** or **{Fw/Hg}** will put Follow on the command line, and **[Shift] & [Delay] [Delay]** or double pressing **{Fw/Hg}** will put Hang.

In the Playback Status Display, any cue that will be triggered by a follow or hang will have an arrow before the cue number. See [Indicators in the Playback Status Display \(on page 64\)](#) for more information. This indicator can be disabled in the PSD configuration menu. See [Playback Status Display Configuration \(on page 66\)](#) for more information.

Following are some examples of use:

- **[Record] <Cue> [5] [Shift] & [Delay] [8] [Enter]** - records cue 5 and provides a follow time of 8 seconds which impacts the start of the next cue in the list. The following cue will automatically initiate on the same fader when the follow time has elapsed. The follow time will begin counting down when the associated cue (Cue 5) is executed.
- **[Record] <Cue> [5] [Shift] & [Delay] [Delay] [8] [Enter]** - records cue 5 and provides a hang time of 8 seconds which impacts the start of the next cue in the cue list. The following cue will automatically initiate on the same fader when the hang time has elapsed. The hang time will begin counting down when the associated cue (Cue 5) is complete.
- **[Record] <Cue> [5] [Shift] & [Delay] [Delay] [-] [5] [Enter]** - records cue 5 and provides a hang time of negative 5 seconds.

To remove a Follow /Hang time:

- **[Cue] [x] [Shift] & [Delay] [Enter]**

## Link/ Loop

Link allows cues to be run out-of-sequence, by causing a different cue number to be loaded into the pending file of the playback fader when the cue that carries the link instruction is activated. If a follow or hang time is included with the cue attributes, the activation of the linked cue will occur when the follow or hang time has elapsed.

The link can be within the cue list or to a cue in another cue list.

Cues that link to other cues will display this information in a row under the cue in the Cue List Index and the Playback Status Display. This can be suppressed in the PSD configuration. See [Playback Status Display Configuration \(on page 66\)](#) for more information.



**Note:** If a linked cue has a label, the label will be displayed in the link cue indicator.



Following is an example of using link:

- **[Record] <Cue> [2] {Link/Loop} <Cue> [8] [Enter]** - records the specified cue 2 and provides a link to cue 8 in the cue list. When cue 2 is played back, the linked cue is loaded into the pending queue of the associated fader.

Loop is provided as a method to link a series of cues and loop them a number of times in a sequence. Once the sequence of cues has played back the first time, the system recognizes the loop command and plays the sequence again, provided the target of the link is a previous cue.

If the first cue in the sequence is a cue with an assert attribute or has move instructions for channels, values from the last cue are not allowed to track through into the first cue when it is looped back. But without a move or assert in the first cue, values from the last cue will track into the first cue when it loops back.

A loop specified with "0", loops the sequence indefinitely.

Following is an example of using loop:

- **[Cue] [2] {Link/Loop} <Cue> [1] {Link/Loop} [3] [Shift] & [Delay] [4] [Enter]** - records a link from cue 2 back to cue 1. Because there is a follow time, cue 1 will automatically trigger 4 seconds after cue 2. If cue 1 also has follow time, it will automatically trigger cue 2. This sequence will run 4 times (once plus 3 loops) and then stop in cue 2. The loop value specifies the number of times the loop instruction will be performed. Since the sequence has run once prior to the loop command, the total number of passes will be the specified number of loops +1. You could use **{Go After Loop}** to execute the next cue after a follow link/ loop sequence has ended. See [Using External Links \(on page 265\)](#)

## Delay Time

Delay can be useful when you do not want a parameter to change (for example - intensity down) until other changes have begun or completed their transition.

Delay times can be added to any cue or to any specific parameter category within the cue, which will postpone the parameter transition until the delay time has elapsed.

Following are some examples of recording with a delay:

- **[Record] <Cue> [2] [Delay] [5] [Enter]** - stores cue 2 with a 5 second delay on intensity.
- **[Record] <Cue> [2] [Time] [9] [Delay] [3] [Enter]** - records cue 2 with a 9 second fade for all parameter categories, delayed from Go by 3 seconds.
- **[Record] <Cue> [2] [Time] [7] [Delay] [Enter]** - records cue 2 with a 7 second fade, and removes delay time.
- **[Record] <Cue> [2] [Delay] [/] [5] [Enter]** - records cue 2 with a 5 second delay on the downfade.

Delay can be used to affect only the parameters in the specified category.

- **[Record] <Cue> [2] {Color} [Delay] [8] [Enter]** - records cue 2 with a delay time of 8 seconds for the color category.
- **[Record] <Cue> [2] [Time] [Time] [Time] [Delay] [7] [Enter]** - records cue 2 with a cue level focus delay time of 7. In this example, each press of the **[Time]** key steps through each timing value (up time, down time, focus time, color time and beam time).

## Rate

The **{Rate}** softkey can be used to apply a rate adjustment to all timing in the cue. The default rate is 100%, which is real time. To slow a cue down, set the rate below 100%. To speed the cue up, set the rate above 100%. The range rate for a cue is 0 - 2000%. A timing value of 5, with a rate of 50% will replay in 10 seconds. A timing value of 5, with a rate of 200% will replay in 2.5 seconds.

Following is an example of using rate:

- **[Record] <Cue> [4] {Attributes} {Rate} [1] [2] [5] [Enter]** - records the specified cue, and places a rate override instruction on all timing values. The cue would now be played back at 125% of recorded time values.



**Note:** You can use the playback rate override function to determine the rate at which you want to play the cue back, and then apply that rate to the cue. This eliminates the need to adjust all of the timing in the cue if you only need to speed it up or slow it down. See [Using Rate Override \(on page 313\)](#).

---

## Curve

**{Curve}** is used to affect the percent completion of a cue or part by applying the curve's output level as the percent completion for all fade calculations.

When a curve is applied to cue, it impacts only the intensity transitions in that cue. When applied to a cue part, it impacts any parameters moving in that part. For more information on creating and using curves, see [About Curves \(on page 378\)](#)

Following is an example of how to assign a curve to a cue:

- **[Cue] [6] {Attributes} {Curve} [5] [Enter]** - applies curve 5 to cue 6.

## Cue Label

**[Label]** is used to attach an alphanumeric label to a cue or cue part.

Following is an example of how to apply a label to a cue:

- **[Record] <Cue> [7] [Label] <name> [Enter]** - records cue 7 and applies the label as entered on the alphanumeric keyboard.
- **[Record] <Cue> [8] [Label] [Block] [Enter]** - records cue 7 and applies the name of the hardkey as the label

Pressing **[Label]**, when a label has already been applied to a cue, will display the label on the command line for editing. Pressing **[Label]** a second time will clear the label, or you can press **[Clear]** to remove the label one character at a time.

## Cue Notes

Cues can have notes attached to them.



These notes can be viewed in the Playback Status Display and the Cue List Index by hovering a mouse over or tapping on the + in the Label column.

You can also select to view the notes or the notes for the pending cue in a horizontal bar at the bottom of the PSD. See [Playback Status Display Configuration \(on page 66\)](#) for these additional display options.

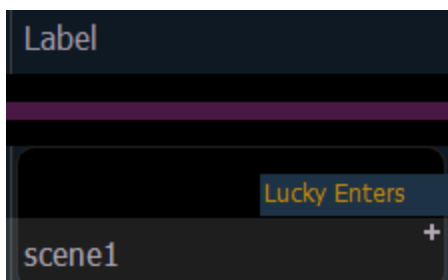

To add a note to a cue:

- [Cue] [n] {Attributes} {Notes}

To add a note to the currently selected cue, you can use [Shift] & [Label].

You can use the virtual alphanumeric keyboard or an external keyboard to enter the desired text.

See [Copy To and Move To for Labels, Scenes, and Notes \(on page 295\)](#) for more information.

## Scenes

Scenes are a cue organization tool that provide a visual identifier for breaks in your show. Scenes allow for quick cue list navigation without needing to remember a cue's number.



Scenes display in the cue list index and the playback status display as a green bar above the cue they are associated with in the list. An end of scene can also be created, and those display as a green bar under their associated cue.

### Creating a Scene Break

You can add a scene break by using the {Scene} softkey. For example, [Cue] <1 > {Attribute} {Scene} will add a scene to cue 1.

The virtual alphanumeric keyboard will open. You will need to label the scene before it is created.

See [Copy To and Move To for Labels, Scenes, and Notes \(on page 295\)](#) for more information.

## Creating a Scene End

You can specify where a scene ends by using the **{Scene End}** softkey. For example, **[Cue] <5 > {Attribute} {Scene End}** will add a scene end to cue 5.

You can create a scene and a scene end at the same time by using **[Thru]**. For example, **[Cue] [1] [Thru] [5] {Scene}** will add a scene to cue 1 and a scene end to cue 5.

## Update Using Scene End

The **{Scene End}** softkey can also be used when updating the cues in a scene. For example, **[Update] <Cue> [1] [Thru] {Scene End}** will put the last cue of that scene on the command line.



**Note:** *Tracking / cue only rules still apply. If your console is in tracking mode, and you want the update to stop at the scene end, you will need to use the **[Q Only]** command.*

---

## Using a Scene Break

You can recall a scene to quickly jump to a cue without needing to remember its number. To recall a scene, use the **[Go to Cue]** button and select the **{Scenes}** softkey.

This will open up the scene selection display in the CIA. The scene's label and cue will display. Press or click on the scene to select it.

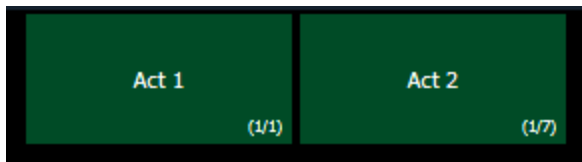

Scenes can also be recalled by using the direct selects. See [Scenes on Direct Selects \(on page 72\)](#) for more information.

## Deleting a Scene Break

To delete a scene or scene end, you will need to use the following syntax:

- **[Cue] [n] {Attributes} {Scene} [Label] [Enter]** - deletes the scene.
- **[Cue] [n] {Attributes} {Scene End} [Enter]** - deletes the scene end.

## Clearing Cue Attributes

To clear attributes from a cue:

- **[Cue] [n] [Shift] & [Delay] [Enter]** - removes the follow or hang time from the specified cue "n".
- **[Cue] [n] [Label] [Label] [Enter]** - removes the label from the specified cue "n".
- **[Cue] [n] {Link/Loop} [Enter]** - removes the link instruction from the specified cue "n".
- **[Cue] [n] [Thru] [y] {Attributes} {Rate} [Enter]** - removes the rate instruction in cues "n" through "y".

You may combine these to remove multiple attributes at once:

- **[Cue] [n] [Shift] & [Delay] {Link/Loop} [Enter]** - removes the follow time and link instruction.

## Flags

Flags can be applied to cues to change specific behaviors. Flags can be set for [Block](#), [Assert](#), [AllFade](#), [Mark](#), and [Preheat](#).

### Block

You can apply a block to a cue, a cue part, to any channel (or group of channels), or parameter (or group of parameters) within a cue. Block is an editing function. It has no impact on how the data is played back.

#### *At a cue level*

A cue level block causes all tracked values in the cue to be treated as move instructions from an editing standpoint, which prohibits any data changes from tracking into the cue. Parameters that are not included in the cue are not impacted by the block instruction.

Blocks do not protect a cue, channel or parameter from being modified by a range edit, nor are they protected from a trace instruction (see [Using Trace \(on page 270\)](#)). It is assumed that if you use the trace instruction, then you really want the initial value to change. A block will stop the trace from moving any further backwards through the cue list.

- **[Cue] [5] [Block] [Enter]** - "B" is displayed in the flags field, indicating a cue level block. When this cue is recalled, all data that would otherwise appear as a tracked value, will be displayed in white. Any changes upstream in the cue list will not impact this blocked cue data.
- **[Cue] [6] {Intensity} [Block] [Enter]** - "I" is displayed in the flags field, indicating a cue level intensity block. You could also use **[Shift] & [Block]** to put Intensity Block on the command line.

#### *At a channel/ parameter level*

Blocks can also be applied to a channel or a channel parameter. This can be done in live or blind. When applied in live, the block instruction must be stored or updated to the appropriate cue.

- **[9] [Block] [Enter]** - applies a block to channel 9. A red "B" appears near the channel in the live display, indicating a block has been applied but is not yet stored.
- **[Group] [5] {Color} [Block] [Enter]** - applies a block to all of the color parameters for group 5.

When the block instruction has been stored or updated, any tracked values the block was applied to will be displayed in white.

Channel level blocks are indicated in the cue list by a "b" and auto-blocks are indicated in the cue list by a "b", representing a partial block. To remove auto-blocks, see [Auto-block Cleanup \(on page 277\)](#).

### Auto-block

Eos also supports an auto-block function. Auto-block can protect your cue data from unwanted changes. For example, in cue 5 you set channel 1 to 50%. It is stored as a move instruction. Then, you later go back to an earlier cue and set channel 1 to 50% and it tracks forward to cue 5. Channel 1 will be auto-blocked in cue 5. Even though it is now at the same value as the previous cue, the original concept of a move instruction is maintained.

Auto-blocks are displayed in white, with a white underscore.

## Assert

Assert is a way to make a tracked or blocked value act as a move instruction on playback. It is often used in a multiple cue list environments, or to assure that a transition happens in the desired time. See [Using Assert \(on page 289\)](#) for more information on asserts in multiple cue lists and [Using Assert \(Playback Button\) \(on page 312\)](#) for more information on using assert for playback.

On Element 2, only assert for playback is available.

Assert can be useful in a single cue list.

### Example:

Cue 10 is a blackout with a zero count. It is common practice to block blackout cues. Let's say though that some of the lights were fading to zero in cue 9. You hit **[Go]** for cue 10 before cue 9 is finished. The lights that were fading to zero in cue 9 will continue their downfade in the timing for cue 9 since cue 10 doesn't provide them with a new move instruction. If you assert cue 10, the lights will bump to black as expected.

---

## AllFade



**Note:** *This feature is not available on Element 2.*

---

Any cue can have an allfade flag applied. An allfade sends the intensity for all channels not included in the cue to zero. Submasters, any captured channels and the contribution from any faders that are set to priority are unaffected, unless the cue executing the allfade is also set to priority. An allfade flag "\*" is identified in the cue list index and the playback status display for the specified cue.

- `<Cue> [5] {Attributes} {AF/MF} [Enter]` - sends intensity for all channels not included in the allfade cue to zero.

The allfade instruction is useful as a quick cleanup, to get back to a known state on stage, without having to worry about what channels need to be set to zero.

## Mark

The Mark flag is used to relay information about either automarks or reference marks. When using automarks, an "M" will display in the flags field for the specific cue that will execute an automark. A "D" is displayed when automark has been disabled for a cue or a cue part.

When using reference marks, an "M" will display in the flags field for any cue that will execute a referenced mark. An "R" displays when a cue is the source of a mark. See [About Mark \(on page 216\)](#).



**Note:** *Only AutoMark is available on Element 2.*

---

## Preheat

Preheat can be used to warm filaments in the cue immediately preceding an intensity upfade from 0. Preheat values can be assigned to channels individually in patch (see [{Attribute} Display and Settings \(on page 124\)](#)).

Preheat is assigned on a cue (or cue part) basis. If assigned, any channel in that cue with a preheat value assigned in patch will fade to that intensity in the cue immediately preceding the cue with the preheat flag. Cues with a preheat flag will display an “P” in the preheat flag column (indicated by a “P” at the top of the column) in the PSD and Cue List Index.

When a channel is in a preheat state, a “Ph” is displayed in the intensity field of that channel. When a preheat is executed, the preheat value is established using the upfade time of the associated cue. It is possible to hold the **[Data]** key to see the actual preheat values.

## Using External Links

External links can be used to trigger actions such as macros, show control, or snapshots. Additionally, you can enter instructions that sync the Go of other cue lists.

When you press **{Execute}**, the softkeys will change to **{Time Code}**, **{Macro}**, **{Relay}**, **{On}**, **{Off}**, **{Snapshot}**, **{OOS Sync}**, **{Go After Loop}**, **{MIDI Raw}**, and **{String}**.



**Note:** For information about using **{Relay}**, **{Time Code}**, and **{MIDI Raw}**, please see the sections on [Relay Outputs](#), [Time Code](#), and [Midi Raw](#).

---

To trigger a **macro**:

- **[Cue] [1] {Execute} [Macro] [5] [Enter]** - triggers macro 5 when cue 1 is executed.

To trigger a **snapshot**:

- **[Cue] [3] {Execute} [Snapshot] [3] [Enter]** - loads snapshot 3 when cue 3 is played back.

To trigger a relay either on or off:

- **[Cue][5] {Execute} {Relay}[1] [/] [1] {On} [Enter]** - triggers relay 1/1 on (ACN Group ID / Relay Number)

To trigger a specific cue on another fader:

- **[Cue] [4] {Execute} [Cue] [6] [/] [5] [Enter]**

To trigger cue lists press:

- **[Cue] [1] {Execute} {Cue} [4] [/] [Enter]**
- **[Cue] [1] {Execute} {Cue} [2] [/][Enter]**

When cue list triggers are set, the system will automatically execute same numbered cues on the associated cue list. For example, assume that the last instruction above was applied to cue list 1, cue 1. When cue 1/1 is executed, any cues numbered “1” in cue list 2 will be executed accordingly. If there is not a cue 1 in that list, no action is taken. If there are cue numbers on secondary cue lists that are not in cue list 1, those cues are skipped and the subsequent cue taken as an “out-of-sequence” cue when triggered.

When cues are taken on the primary list out of sequence, only like-numbered cues on the secondary lists will be replayed. For example, if you go to cue 12 on the primary list, and there is a cue 12 on the secondary list, cue 12 on all lists is executed. However, if cue 12 does not exist in the secondary list, that list will be unaffected by the go to cue command. Out of sequence sync can be enabled to make sure secondary lists assume the same position in the show as they would on linear playback.

## OOS Sync

**{OOS Sync}** can be used to change that behavior per cue list.

When OOS Sync is enabled, any out of sequence cue fired from a cue list that is synced with another cue list will trigger the earliest cue that exists if the correct cue does not.

{OOS Sync} is disabled by default. When enabled, OOS Sync will display in the cue list index's external links column. {OOS Sync} should be enabled in the secondary lists, not on the list that contains the execute command.

### Example:

Cue list 1 is synced with cue list 2. Cue 1/3 is fired. Since cue 2/3 does not exist, cue 2/2 will fire instead. If OOS Sync was disabled, a cue in cue list 2 would only fire if it has the same cue number as cue list 1.

## Go After Loop

{Go After Loop} will execute the next cue after a follow link/loop sequence has ended. By default, the loop will end with the last cue in the sequence. {Go After Loop} will use the follow time assigned to the last cue in the sequence.

- [Cue] [5] {Execute} {Go After Loop} [Enter] - assigns the {Go After Loop} command to cue 5. Go After Loop will display in the Ext Links Column of the Cue List index and the PSD.

## Removing an External Link

To remove an external link:

- [Cue] [5] {Execute} {external link option} [Enter]

## Modifying Cues Live

Recorded cues can be modified live. [Assigning Cue Attributes \(on page 257\)](#) (such as link, loop, label and so on) may be edited as well. The cue does not need to be active (played back) to change cue attributes. You may also change cue attributes for a range of cues if you wish.

[Recall From], [Copy To], and Move To may be used to create and edit cue data.

See [Using \[Recall From\] \(on page 295\)](#), [Using \[Copy To\] \(on page 294\)](#), [Move To \(on page 274\)](#) for more information.

## Using [At] [Enter]

A useful feature when editing cues is [At] [Enter]. This is a simple feature which allows you to select any channel or parameter, or several of them, and remove their move instructions, allowing the value from the previous cue to be manually recalled.

[At] [Enter] is essentially a "recall from the previous cue" command.

### Example:

Cue 5 is active in Live.

- [Group] [1] [Focus] [At] [Enter]

This command lifts the current move instructions for Group 1 focus, and recalls the focus data for those lights from the immediately preceding cue. It is now manual, and can be stored or updated as required.

You may use [At] [Enter] to affect only certain channels or parameters by selecting them specifically:

- [2] [At] [Enter] - this will remove the changes for channel 2 only.
- [2] {Color} [At] [Enter] - this will remove only the color data changes for channel 2.

- [2] [Thru] [5] [+] [9] [+] [1] [1] [Thru] [1] [5] [-] [1] [2] [-] {Zoom} [At] [Enter] - removes the changes for only the selected channels for all parameters except zoom.

## Modifying Using Record

You may modify a cue by re-recording it entirely. After making changes to channels/parameters:

- [Record] [Enter] [Enter] - will replace any data in the active cue with the current stage settings.
- [Record] [Cue] [x] [Enter] [Enter] - will replace the any data in cue “x” with the current stage values.

Using selective storing will modify the existing cue without overwriting it. For more information, see [Using Selective Store \(on page 253\)](#)

- [1] [Record] [Cue] [2] [Enter] [Enter] - will only record the changes to channel 1.



**Note:** Using [Record] will store all parameters of all non-default channels onstage. This means that all other cue data and submaster data will be included in the record action. This is a common method when working with a single cue list. When working with multiple cue lists and/or submasters, [Record Only] is a useful tool.

---

## Modifying Using Record Only

Modifying existing cues using [Record Only] is considered a “selective store” function. As such, it adds or modifies only manual data to the target cue, but leaves any other data that was already in the cue intact and does **not** include playback values from other cue lists or submasters. [Record Only] is a good way to modify existing cues without including contributions from other playbacks in the cue. In that way, it is very similar to [\[Update\] \(below\)](#).

All of the same commands used for Record may also be used for Record Only.

- [Record Only] [Enter] [Enter]- adds the current manual data to the selected cue.
- [Record Only] [Cue] [x] [Enter] [Enter] - adds the current manual data to cue “x”.

## [Update]

Update is a powerful feature, and also very versatile. Using a combination of [Q Only], [Track], [Trace], and {Make Absolute}, the number of ways you can update specific information and manual data is virtually endless. Data can be updated to various record targets either at once, or individually.

## Update Dialogue Box

When you press [Update], a dialogue box will open in the CIA. Update styles and modifiers for those styles will be divided in the Update Dialogue Box.



**Note:** Default Update Modes are set in [Setup>User>Record Defaults](#). See [Record Defaults \(on page 159\)](#) for more information.

---



**Note:** {By Type} is available as a softkey. See [Updating By Type Presets \(on page 243\)](#) for more information.

---

## Update Styles

- **{All}** - this button will update the target cue and all references stored to that cue (nested and otherwise).
- **{Make Absolute}** - this button will update the target cue and convert all levels to absolute values, thereby removing any references.
- **{Ref Only}** - this button will only update the palettes or presets used in the cue, but will not update the cue itself. If a manual reference was used before using **{Ref Only}**, the last manual reference will be updated.

## Update Modifiers

- **{Last Ref}** - this button will update using the last reference that was applied.
- **{Break Nested}** - this button will update the target cue and any presets used, but breaks the reference to any palettes nested in a preset. For example, if cue 1 channel 1 references preset 3, and preset 3 was built using color palette 5. When updated with this option, preset 3 would be updated, color palette 5 would not, and the reference to CP5 would be broken in preset 3.
- **{Reset Update}** - this button will clear any commands after the **[Update]** command to quickly undo pending changes before **[Enter]** is pressed.

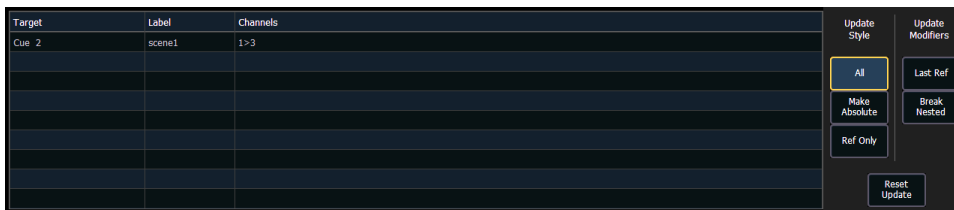

The dialogue box also provides you with a listing (by record target) of what channels/parameters will be impacted by the update instruction. If the channel contains a reference in the cue, it is indicated. Channels that have been manually added to the stage output, but are not overrides of an active cue will update to the selected cue list.

Once you have made a selection from the available options, press **[Enter]** and the target will be updated.

Targets may be deselected from the dialogue box, excluding them from the update without specifying the target number, for example, **[Update] [Color Palette] [Enter]**. Selecting a line by clicking or pressing it can also be used to deselect a target.

## Updating to References

When a cue is active, it is possible that various record targets (palettes or presets) will be played back within that cue. As changes are made to the data in that cue, as well as to the individual palettes or presets, updating both the cue and references within that cue is simple. When you have overridden a reference in a cue, the data is displayed in red with a red "R" in superscript next to the channel's intensity.

By default, Eos updates any referenced data that was included in the cue.



### Example:

Cue 5 is recalled Live. It contains references to color palette 1 and preset 2. You make changes to channels included in these record targets. To update both the cue **and** the palettes/presets, press:

- **[Update] [Enter]**

This will automatically take the manual changes and update them to color palette 1 and preset 2. Therefore cue 5 now references these new values, and the modifications to CP1 and PR2 have propagated through all of the show data.

If you had made changes to other channels that were not included in the palettes/presets used in cue 5, those values would also be updated to the cue as absolute data.

## Updating Without References (Make Absolute)

If you want to record your changes to the cue **without** updating the references, you may use **{Make Absolute}** to break the association to the reference. The **{Make Absolute}** command can be applied to the channels/parameters required before the update instruction, or they can be applied during the update.

- **[Update] {Make Absolute} [Enter]** - this will break the references for any parameters which have been changed and update the cue with the changes. The referenced target will no longer be displayed in the channels which were made absolute. All of the data updated in cue 5 will now be shown as absolute data.
- **[5] [Thru] [9] [Update] {Make Absolute} [Enter]** - this will break only the references for channels 5-9 and record their manual values to the cue. Other manual values will not be included in this update.

You may also use **[Record Only]** to break references.

### Example:

Cue 5 is active and onstage. Channels 5 through 20 are currently referencing preset 1. You make changes to channels 5 through 9. The data for these changes is now manual. Press:

- **[Record Only] [Enter] [Enter]**

If there were other changes on stage, you could have used:

- **[5] [Thru] [9] [Record Only] [Enter] [Enter]**

Only the manual data will be recorded as an update to cue 5. The reference to preset 1 for channels 5 through 9 is broken and now the cue will display the absolute data rather than the reference indicator.

## Update Using Cue Only/Track

The **[Q Only/Track]** key can be used as an applied exception to the cue only/track system setting. Therefore if the system is set to Cue Only, the key behaves as a **[Track]** command. Alternatively, if the system is set to Track, the key behaves as a **[Q Only]** button.

For a more detailed summary of Cue Only and Tracking modes, please see [Tracking vs. Cue Only \(on page 6\)](#).

**[Q Only/Track]** can be used in conjunction with record or update functions. Following are some examples of use:



**Note:** In the following examples, the commands **[Q Only]** and **[Track]** indicate the same key hit of **[Q Only/Track]** - a single button on the keypad. The system setting determines the actual context of the button. For clarity, only the contextual function of the button is used in the examples.

### **With system set to Track**

- **[Record] <Cue> [5] [Q Only] [Enter] [Enter]** - rerecords cue 5. This will make the changes to cue 5 **only**. The changes will not track forward through the list.
- **[-] [Color] [Record] <Cue> [5] [Q Only] [Enter] [Enter]** - as above, but changes to color parameters will not be included in the record and all data that was included will not track forward. Color data in the cue remains unchanged.
- **[Update] <Cue> [5] [Q Only] [Enter]** - updates cue 5 with only those manual parameters that were receiving their instructions from that cue. The changes will not track forward in the list. Note that if the data being updated were referenced, this action updates the referenced target as well.
- **[-] [5] [Record] <Cue> [7] [Q Only] [Enter] [Enter]** - rerecords the specified cue, except the contributions from channel 5. The changes will not track forward in the list.

### **With system set to Cue Only**

- **[Record] <Cue> [5] [Track] [Enter] [Enter]** - rerecords cue 5. This will force the changes to track forward in the list until the next move instruction or block.
- **[-] [5] [Color] [Record] <Cue> [7] [Track] [Enter] [Enter]** - rerecords the specified cue, except the color data from channel 5. The recorded changes will track forward in the list.
- **[Update] <Cue> [3] [Thru] [7] [Track] [Enter]** - updates cues 3 through 7. Range updates are subject to the normal rules of track/cue only in determining impact on subsequent cues.

## **Using Trace**

**[Trace]** works just as **Track** does, except it allows changes to be tracked backwards through the cue list, until it sees a move instruction. A trace will track into, but not beyond, a blocked instruction.

For a more detailed summary of Trace, please see [Using Trace \(on page 7\)](#)

Following are some examples:

- **[Update] <Cue> [5] [Trace] [Enter]** - updates cue 5, and tracks changes backward until a move instruction is encountered. If the system is in tracking mode, the change will track forward in the cue list until the next move instruction or block. If in cue only mode, this has no impact on subsequent cues.
- **[Update] [Trace] [Cue Only/Track] [Enter]** - updates the selected cue and tracks changes backward until a move instruction is encountered. If the system is in tracking mode, the change is prohibited from tracking forward in the list. If in cue only mode, the change is allowed to track forward.

When a channel that is inactive (at zero or null) in the cue list receives an active level, if update trace is used, that channel will not trace the current setting into previous cues.

To force that channel's new value to go backward in the cue list, **[Trace] [Trace]** can be entered.

## **Updating the Current Cue**

The current cue is updated by simply pressing **[Update] [Enter]**.

When only one cue list is active, this update will include any changes to all channels.

## Updating a Source Cue

To update the source of a level in the current cue (therefore, a move instruction in a prior cue) you must specify a trace for the desired channel(s). See [Using Trace \(on the previous page\)](#)

- **[5] [Update] [Trace] [Enter]** - Updates any manual changes for channel 5 in the current cue. Any tracked values for channel 5 are traced back to the source of the value (the original move instruction) and changed to the new value. The value for traced changes in the current cue will be magenta indicating it is a tracked value.
- **[Trace] [Trace]** - If a channel was inactive in the cue (either because it had not previously been used in the cue list, or it was a tracked zero) and is set to a new level, by default the new level will not track back. You can force it by pressing **[Trace]** twice.

## Updating a Non-Active Cue

It is possible to use the same update commands as current ([Updating the Current Cue \(on the previous page\)](#)) and source cues ([Updating a Source Cue \(above\)](#)) to update inactive cues (cues not live onstage). In these situations, if the updated cue is not the source of a channel's live value, manual data will remain manual. If the updated cue **is** the source of the current value, the values will change to magenta (indicating tracked) when the update is completed.

## Update [Thru]

Using **[Update] [Thru]** allows you to update from a current cue to a destination cue without first entering the current cue's number.

### Example:

If you are currently in cue 5 and you want to update through cue 10, you would use the following syntax:

- **[Update] [Thru] <Cue> [10] <CueOnly/Track> [Enter]**

## Update [+]

**[+]** can be used to specify a range of cues for updating. **[+]** can also be used with **[Record]** and **[Record Only]**.



**Note:** *If no cue number is entered before the **[+]**, the current active cue will be used.*

### Example:

To update only cues 5, 10, and 15:

- **[Update] <Cue> [5] [+ <Cue> [1][0] [+ <Cue> [1][5] <CueOnly/Track> [Enter]**

To update the current cue and cue 7:

- **[Update] [+ <Cue>[7] <CueOnly/Track> [Enter]**

## Recording and Editing Cues from Blind

When you press blind, the selected cue will be displayed. You can make changes to cues in the blind display using either the summary, table, or spreadsheet views.



**CAUTION:** Edits in blind take effect immediately. [Record] or [Update] commands are not required in blind.



**Note:** To force blind to the selected cue, press [Blind] [Blind].

If changes are made in the blind display to an active cue, these changes will not impact the current stage state. To make blind changes active you can press [Assert] & [Load] button for the fader associated with the cue, or you can use [Go To Cue] [Enter].

Move instructions can be removed from a cue by selecting the channel and pressing [At] [Enter]. This allows all values from the previous cue to track into the current cue. You can also use this command for specific parameters as well.

### Example:

Suppose you are in blind cue 5 and you make changes to channels 1 through 5:

- [1] [Thru] [5] [At] [5] <0> {Iris} [3] [5] [Enter]

Intensity goes to 50% and Iris to 35%. You decide to remove the Iris instruction:

- {Iris} [At] [Enter]

The Iris value from the previous cue tracks in. Then you remove the intensity change as well:

- {Intensity} [At] [Enter]

All values from the previous cue track in.

Instead of using multiple commands, you can, in one command, return the channels to their values from the previous cue:

- [1] [Thru] [5] [At] [Enter]

The impact of blind edits on subsequent cues is determined by the default setting of Track/ Cue Only mode. In track mode any changes will track forward until the next move instruction, unless [Q Only] is pressed. In cue only mode any changes will apply only to the selected cue. If you want values to track forward, the [Track] button will allow it. The track/cue only instruction must be applied when a value is entered. [Trace] can also be used to have changes trace back to the initial move instruction. Such as:

- [1] [Thru] [5] [At] [5] <0> [Q Only/Track] [Enter]
- {Intensity} [At] [Q Only/Track] [Enter]
- [1] [Thru] [5] [At] [5] <0> [Q Only/Track] [Trace] [Enter]

## To Live From Blind

From blind, a softkey {Live} is posted when you press [Recall From] or [Copy To] to allow you to copy to or recall information from live. The following examples only work with the {Live} softkey, not the [Live] hard key.

- [1] [Recall From] {Live} [Enter]
- [2] [Copy To] {Live} [Enter]

## Editing From Summary or Table Views

Use the [Format] key to cycle through the available views.

Summary view allows you to see the greatest number of channels at once, though parameter data is somewhat truncated. Channels with focus, color, or beam data are indicated with + symbols beneath the level data. This view is useful for viewing lots of channel data at once or for editing primarily intensity values.

Table view grants you greater visibility of parameter data and a reduced number of visible channels. This view displays channels along the y axis and parameters along the x axis. Parameter categories are always visible (I, F, C, and B).

You can also view specific parameters by pressing and holding the **[Params]** button and then pressing the category softkey(s) for the parameters you wish to view. This will expand the category to show any parameters used in the show. You can also deselect the parameters you do not wish to see. This is remembered the next time you go to table view.

Both summary and table views allow you to make changes to channels/parameters.

## Editing From the Blind Spreadsheet

The blind spreadsheet is another useful blind view of cue data. While in blind, press **[Format]** to access the spreadsheet. See [Spreadsheet \(Blind Only\) \(on page 51\)](#) for more information.

In spreadsheet view, cues are listed on the y axis and channels/ parameters are displayed on the x axis. This view is useful for showing a limited number of channels over a span of numerous cues. This is the only view where channel data of multiple cues can be viewed at once. This makes spreadsheet view useful for viewing overall trends in channel and parameter data.

Pressing **[Params]** & **{parameter tiles}** will expand or collapse information shown.

Editing cue ranges is possible in spreadsheet view. To select all of the cues, you can press **[Cue]** **[Home]** **[Thru]** **[Enter]**.

### Replace With

**{Replace With}** is used to select channels that have certain specified values and then provide new instructions for those values.

#### Example:

Select a range of cues:

- **[Cue]** **[1]** **[Thru]** **[9]** **[Enter]**

Select a range of channels that are used throughout these cues and enter a change instruction:

- **[1]** **[Thru]** **[7]** **<At>** **[Color Palette]** **[5]** **{Replace With}** **<Color Palette>** **[3]** **[Enter]**

This instruction finds all instances of channels 1 through 7 in cues 1 through 9 that are in color palette 5 and replace Color Palette 5 with Color Palette 3. Be aware of the track/ cue only settings when using this command.



**Note:** **[Cue]** **[Home]** **[Thru]** **[Enter]** will select all stored cues within the selected cue list. **[Thru]** **[Enter]** can be used with all record targets.

The range of possibilities of potential **{Replace With}** commands is virtually endless and can be applied to single cues or channels, ranges of cues or channels, parameters of any type, or timing data.

## Move To

**Move To** is used to move cues from one location in a cue list to another location in the same or a different cue list.

On Element 2, **Move To** is used to move cues from one location in a cue list to another location in the list.



**Note:** To put **Move To** on the command line, press **[Copy To]** twice.

---

When cues are moved, values that were tracks or move instructions and **now** match the previous cue will be auto-blocked by the system. The impact on subsequent cues is based on track/cue only settings as described above. Below is an example of **Move To**:

- **[Cue] [2] Move To <Cue> [9] [Enter]** - the contents of cue 2 moves to cue 9. Cue 2 is deleted. If cue 9 already existed, a confirmation will be required (unless confirmations have been disabled in setup). Any contents of cue 9 will be replaced entirely.

In the above example, if running in cue only mode, any tracked values in cue 2 become blocks (see [Block \(on page 263\)](#)) or moves in cue 9, as well as any move instructions which now match the previous cue. Cues after cue 9 are affected based on the default setting of track/ cue only. Any values in the cue after cue 2 that tracked from moves in cue 2 are changed to move instructions.

Ranges of cues can be moved as well. You can also move cues to other cue lists. In either of these situations if any cue is to be overwritten, a confirmation is required.

See [Using Move To \(on page 295\)](#) for more information.

## Using Encoders in Blind

The encoders are disabled by default in blind. Press an [encoder paging key] prior to moving the encoders, and they will function while you remain in Blind.

When a cue is specified, you can select channels and alter parameters using the encoders. **[Q Only/Track]** can be placed on the command line to determine how these changes will impact subsequent cues.

## Deleting Cues

Cues, lists of cues, or ranges of cues can be deleted. When deleting cues, the track/ cue only setting of the console will determine how subsequent cues are affected. The **[Q Only/Track]** button can be used to modify the default behavior as needed.

Some examples of cue deletion are:

- **[Delete] <Cue> [5] [Enter] [Enter]** - deletes cue 5. Subsequent cues in the list are affected depending on the console default setting.
- **[Delete] <Cue> [6] [Q Only/Track] [Enter] [Enter]** - deletes cue 6, making exception to the default setting.
- **[Delete] <Cue> [7] [Part] [1] [Enter] [Enter]** - deletes part 1 of cue 7. Deleting a part does not delete any move instructions. Those will be moved to the main cue. See [Deleting a Part from a Multipart Cue \(on page 321\)](#)
- **[Group] [1] [Delete] <Cue> [2] [Enter]** - deletes any channels in group 1 from cue 2. Cue 2 remains in the cue list and any channels not in group 1 are unaffected.
- **[Delete] <Cue> [2] [Thru] [8] [Q Only/Track] [Enter] [Enter]** - deletes cues 2 through 8, making exception to the default setting.

## Deleting In Track Mode

When the console is in track mode, deleting a cue also removes any move instructions provided by the cue. For example, assume you have stored cues 1 through 10 and cue 5 contains move instructions for channels 1 through 5. If cue 5 is deleted, the move instructions are deleted as well and the values from cue 4 will track directly into cue 6 and beyond.

In this instance, if you used the **[Q Only]** button in the delete instruction, cue 5 would be deleted, but the tracked values in cue 6 that originated in cue 5 would remain and be converted to move instructions.

## Deleting In Cue Only Mode

When the console is in cue only mode, any subsequent tracked values are not eliminated, but are converted to move instructions instead.

In the example above, deleting cue 5 (in cue only mode) would result in any tracked values in cue 6, that originated in cue 5, being converted to move instructions.

If you apply the **[Track]** button to the delete instruction, the move instructions from cue 5 are deleted and the values from cue 4 would then track into cue 6 and beyond.

## Using The Cue List Index

The cue list index is a blind display list which shows the cue list you are working with, the cue status, cue list properties, any other stored cue lists, and what (if any) faders the lists are loaded onto.

When the cue list index is in focus, the following softkeys are available for editing the cue list: **{Partition}**, **{Autoblock Clean}**, **{Solo Mode}**, **{Execute}**, **{Properties}**, and **{Edit}**.

## Opening the Cue List Index

You can access the cue list index by pressing **[Cue] [Cue],[Tab] [1][6]**, or you can navigate within the browser to Record Target Lists > Cue List Index and press **[Select]**.

The screenshot displays the BLIND console interface. At the top, the title bar shows "BLIND 2 1" and "Assigned Cue List Properties 7:35:21 PM". Below this, a table titled "List 1" shows cue data for "Act 1". The table has columns for Cue, Int Up, Int D..., Focus, Color, Beam, Dur, MB A P F V R, Fw/Hg, Link, Loop, Curve, Rate, Label, FX, and Ext Links. Cues 1 through 5 are listed with various parameters and values. A yellow box highlights the "String BX Analog TX/RX Proportional" header. Below the cue list, a table titled "Cue List" shows properties for cues 1 through 6. The table has columns for Cue List, Fader, Master, Label, Cues, HTP, Assert, Priority, Bkgrd, Phantom, Back From First, Go From Last, Stomp, and Ext Links. A yellow box highlights the "Move Boundary Icon" label. At the bottom, a status bar shows "1 Blind Table: 16 Cue List Index" and "BLIND: Cue 1 / : Cue 1 /".

Cue list properties determine how the cue list will interact. Assigned properties will display at the top of the cue list as well as any currently active show control triggers.

The top half of the cue list index displays all stored cues, including cue list properties, for the selected cue list. The bottom half of the cue list index displays all stored cue lists and their properties. The selected cue list is highlighted.

Using the mouse, you can move the barrier between the stored cue display (top) and the stored list display (bottom). Hover the mouse arrow over the list boundary until it changes to the move boundary icon. Then click and drag the boundary up or down to the desired height.

### **Command Line Behavior for Cue List Index**

The command line while in the Cue List Index defaults to cue list selection. The softkeys that display will default to cue list control.

**[Next]** and **[Last]** will select the next or last cue list if no cue list or a cue list but no cue is on the command line.

When a specific cue is selected, **[Next]** and **[Last]** will move through the cues in that same list, and the softkeys will change to be for a single cue control.

### **Partitions on Cue Lists**

A partition ([About Partitioned Control \(on page 438\)](#)) may be assigned to a cue list. If a partition has already been applied to a cue list, any channels not in the cue list's partition will not be included in cues when they are stored or replayed.

Any data for a cue list that already existed before a partition is applied, will be maintained, including data for channels not included in the partition. If data existed before the partition was assigned, in blind, channels that are not in the partition will display without a channel graphic, any levels will be in gray, and a small superscript N will display with it.

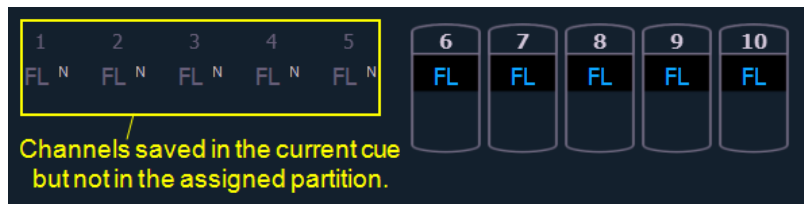

Assigned partitions will display at the top of the cue list index and in the PSD.

To assign a partition to a cue list:

- **[Cue] [n] [/] {Partition} [n] [Enter]**

To remove a partition from a cue list:

- **[Cue] [n] [/] {Partition} [Enter]**

### **Solo Mode**



**Note:** *This feature is not available on Element 2.*

---

The **{Solo Mode}** softkey is useful in multiple programmer situations. **{Solo Mode}** is used to pull a cue list out for editing purposes after it has been synced with other cue lists.



## Example:

Cue List 1 is being used by one programmer and Cue List 2 was programmed by a second programmer. For the run of the show, the lists are synced so they run together. But if changes need to be made to Cue List 2 and not be affected by the playback of Cue List 1, **{Solo Mode}** can be used.

- **[Cue] [2] [/] {Solo Mode} [Enter]** - places Cue List 2 into solo mode.

**{Solo Mode}** is a toggle state. So if Cue List 2 is already in solo mode, and **[Cue] [2] [/] {Solo Mode} [Enter]** is used again, that list will no longer be in solo mode.

## Auto-block Cleanup

**{Autoblock Clean}** is used to remove all auto-blocks from a single cue, cue range or entire cue list. **{Autoblock Clean}** is a softkey that will be posted when a cue list and/or cue number are on the command line in the Cue List Index, Live, and Blind. A range of cues or a cue list can be specified with this command. For more information about auto-blocks, see [Auto-block \(on page 263\)](#)

- **[Cue] [1] [/] {Autoblock Clean} [Enter]** - clears all auto-blocks from cue list 1. Only blocks displayed with the white underscore are removed. If the **[Block]** key was previously used, this command will not unblock it.
- **[Cue][1] [/] [1][0] [Thru] [1][0][0] {Autoblock Clean} [Enter]** - clears the auto-blocks just from cues 10 through 100 of cue list 1.

## Edit

The **{Edit}** softkey opens a blind channel view of the selected cue and changes focus from the cue list index. You can change the blind display to spreadsheet or table view by pressing the **[Format]** key. You can edit any of the cue attributes for the cue selected in the index, but the cue contents must be be edited in the blind display. See [Recording and Editing Cues from Blind \(on page 271\)](#).

## Cue List Index Configuration

The Cue List Index has a configuration menu, which is accessed by first selecting the Cue List Index tab and then double clicking on the tab to open the menu. With the Cue List Index selected, you can also select the gear icon, which is located by the tabs, to open the configuration menu.

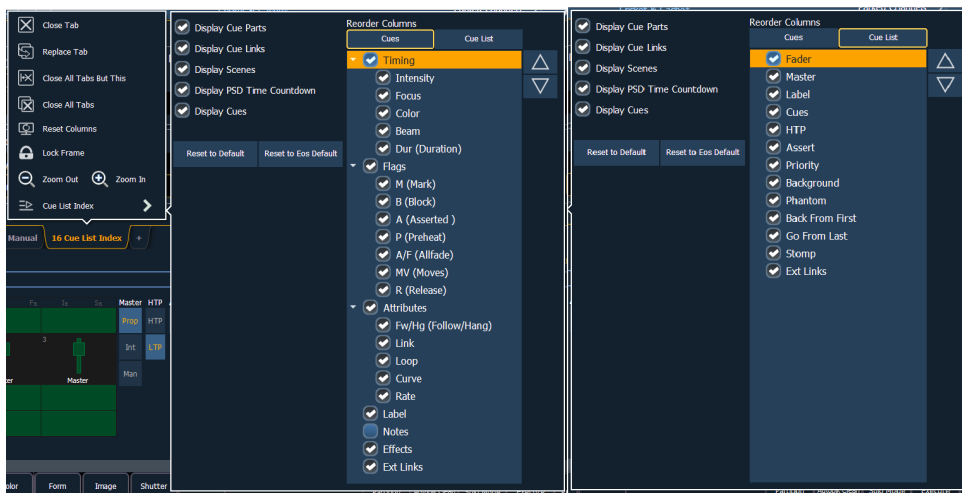

The following options are available in this configuration menu:

- **Display Cue Parts** - displays the individual parts of a part cue. When not enabled, the number of parts for that cue will display as a superscript number beside the cue's number.
- **Display Cue Links** - displays the [Link/ Loop](#) information.
- **Display Scenes** - displays cue [scene information](#).
- **Display PSD Time Countdown** - displays the cue category times countdown in the PSD as a cue is fading.
- **Display Cues** - displays the top half of the cue list index, which shows all the stored cues. This option is not available on Element 2.

## Reorder Columns

Reorder columns allows you choose what data displays in the top and bottom halves of the Cue List Index and what order it displays in. To make changes to the top half, select **{Cues}**. To make changes to the bottom half, select **{Cue List}**.

By default, all columns except notes will be displayed. The arrow keys on the right can be used to move columns around. Columns with multiple options are moved in groups. To select a column header to move, click or tap the name. The check boxes suppress or enable. When an item is enabled to display, a check mark will be in the corresponding box.

## Default

The Cue List Index takes its default settings from the Playback Status Display. The default is identified with parentheses. See [Playback Status Display Configuration \(on page 66\)](#) for more information.

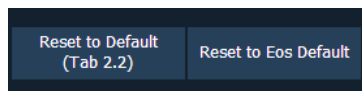

- **Reset to Default** - returns the settings to the default state that you created.
- **Reset to Eos Default** - returns all settings to the Eos defaults.

## Cue List Properties

When the cue list index is open, the cue list properties dialogue box will display in the CIA. The cue list properties determine how the cue list will interact.

On Element 2, the cue list cannot be assigned to a fader. These settings will only impact the master fader pair.

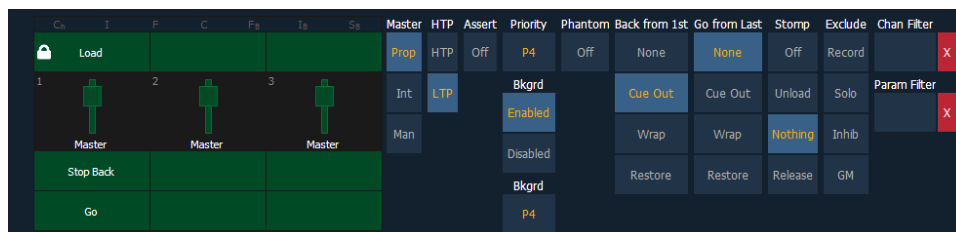

Cue list properties include:

- Master type (Proportional, Manual Master, or Intensity Master)
- Intensity HTP or LTP setting (default is LTP)
- Assert
- Priority

- Background
- Background Priority
- Phantom
- Back from 1st
- Go from Last
- Stomp
- Exclude
- Channel Filters
- Parameter Filters

Faders can be mapped to a cue list in the fader configuration display or by using **[Load]**, see [Selected Cue](#) for more information. If a fader has been configured for default mapping ( see [Fader Configuration \(on page 78\)](#) for more information), the fader will receive its configuration from the Cue List Index. Changes made to a cue list in the cue list index will be shared with any default mapping faders loaded with that cue list. If changes are made to a fader set to default mapping in the fader configuration display, those changes will also happen in the Cue List Index. If set to Local, any changes made in the fader configuration display will impact only that instance of the content.

## **Master**

A fader can be assigned as a Master. When it is a master, its behavior as a Proportional Master, Manual Master or Intensity Master (I-Master) is drawn from this setting.

- Proportional faders, when the slider is set to zero prior to the execution of a cue, will withhold playback of intensity data until the fader is raised. Intensity data will then be played back proportionally according to the level of the fader. Once the fader reaches full, the cue is considered complete and the cue is released from the manual fader. If the fader is at any value other than zero when the cue is executed, intensity values will play back normally. If the slider is returned toward zero, intensity in the cue will fade to the previous level.
- Intensity Masters will master the intensity level for cues during playback. Therefore, intensity masters set below 100% will proportionally limit playback of intensity data relative to the level that the fader is set. All non-intensity parameters are unaffected by the fader. Once the fader has reached full, control of intensity is retained. If the fader is moved toward zero, intensity will proportionally fade toward zero (not the previous state as per proportional faders).
- In Manual Master mode, cues are triggered manually by faders without using the **[Go]** button. With a cue list on a fader set to manual master, a cue will fire in manual time when the fader is moved from 0% or from Full. Timing is scaled. So, if color has a 5 count delay, and the duration of the cue is 10, the color transition will not begin until the faders manually reach 50%. Follow and hang times will be ignored when firing a cue with a manual master fader.

## **HTP**

Intensity playback behavior can be set to HTP (highest takes precedence) or LTP (latest takes precedence). For cues, it defaults to LTP.

## **Assert**

Assert can be turned on or off at the fader level. This property sets the entire cue list to be asserted on playback (even track instructions are replayed).

## Priority

---



**Note:** Priority was previously called Independent.

---

Priority is used to protect values from being affected by submasters or playback faders that have a lower priority level. They will, however, still be impacted by manual control, grandmaster, blackout, park instructions, or other playback faders and submasters at the same or higher priority.

There are 10 levels of Priority that cue lists can have. 1 is the lowest level and 10 is the highest. The default priority level is 4.

### **Background**

Background can be enabled or disabled at the fader level. When enabled, the content of the cue list will act as a background or previous state for other cues and submasters. When a cue list has its background state disabled, a "D" will display in the Cue List Index background column.

### **Background Priority**

Background can have a priority assigned to it.

In previous software releases, when content was released, it always returned to the last fader that owned it. Background priority releases to the highest priority content that previously had ownership, provided that content has not be turned off or released.

There are 10 levels of background priority. 1 is the lowest level and 10 is the highest. The default background priority level is 4.

### **Phantom**

When a cue list is set to Phantom, pressing **[Go]** will not change the selected cue on the command line, or an unlocked playback status display.

### **Back From First**

Back From First controls the behavior that happens when you press the **[Back]** button while in the first cue.

The following are Back From First options:

- **Do Nothing** - keeps the first cue active.
- **Cue Out**(Default Setting) - only fades out channels in that cue list. Other channels will remain. Intensity and non-intensity parameters will be homed. This setting uses the Back time for fading.
- **Wrap** - puts the last cue in the list in pending, and fires said cue.
- **Restore Background** - any background cue, submaster, and effect levels are restored following background priority. Manual levels will not be restored. This setting uses the Release time set in Setup. See [Manual Control \(on page 160\)](#) for more information.

### **Go From Last**

Go From Last controls the behavior that happens when you press the **[Go]** button while in the last cue.

The following are Go From Last options:

- **Do Nothing** (Default Setting) - keeps the last cue in the list active.
- **Cue Out** - only fades out channels in that cue list. Other channels will remain. Intensity levels will go out. Non-intensity parameters will remain. This setting uses the Go to Cue timing for fading.
- **Wrap** - puts the first cue into pending, and fires it.
- **Restore Background** - any background cue, submaster, and effect levels are restore following background priority. Manual levels will not be restored. This setting uses the Release time. The pending cue will be set to the first cue in the list. If there is no background state, the non-intensity parameters will not fade.

## Stomp Mode

Stomp refers to when all the content owned by a cue is now being controlled by other targets. The cue is being removed from the background, and once that happens, it would not be eligible to fade back. You can assign behavior that will happen when a cue is stomped.

The following are Stomp Mode options:

- **Off When Stomped** - puts the content into an off state, the same behavior encountered when pressing **[Off] + [Load]**.
- **Unload When Stomped** - unloads the fader.
- **Nothing When Stomped** (Default Setting) - nothing happens.
- **Release When Stomped** - resets a cue list to the top of the list.

## Exclusions

Those exclusions include:

- **Exclude From Record** - output is not recorded into any other record target.
- **Exclude From Grandmaster** - content cannot be mastered by a grandmaster.
- **Exclude From Inhibitive Sub** - content cannot be mastered by an inhibitive submaster
- **Exclude From Solo** - content will ignore solo button mode. See [Fader and Button Configuration \(below\)](#) for more information on solo.

## Channel and Parameter Filters

Channel and Parameter Filters can be used to allow only specified data to be played back. These are playback filters, and do not impact how data is recorded.

For cue lists, channel and parameter filters can be set in the following areas:

- Cue List Index using the **{Properties}** softkey
- In Fader Configuration (Tab 36)
- In Live using the **{Properties}** softkey

Tap or click on **{Chan Filter}** to assign channels or groups. Tap or click on **{Param Filter}** to open a list of available parameters that you can filter.



**Note:** *Filters will travel with their assigned cue lists wherever they are mapped.*

---

When a filter has been applied, an indicator will display in the fader ribbon. C will display for channel filter, and F is for parameter filter.

Press the red **[X]** to clear the channel or parameter filters listed.

## Fader and Button Configuration

Click or tap on the virtual buttons or fader to see a list of available configuration options.

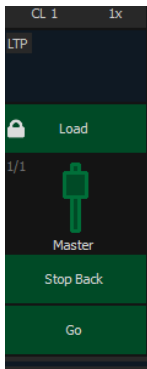

## Button Options

The following options are available for playback buttons:

- **Go** - executes the cue currently in the pending file of the associated fader.
- **Stop Back** - instantly stops all fader activity. Pressing twice will fade to the previous cue on that fader.
- **Assert** - can be used to re-run the active cue on that fader, to regain control of all cue contents, to apply a newly set higher priority state to the associated fader, or make any changes in blind to an active cue on stage. This option is not available on Element 2.
- **Group Select** - selects the channels stored in the cue.
- **Freeze** - halts all effect activity on the fader. Press Freeze again to resume effect activity.
- **Off** - removes the content and if the fader is set to Master, the fader will remain where it currently is.
- **Release** - removes the content and if the fader is set to Master, the fader will reset to 0.
- **Start Stop Effect** - starts the effects while ignoring dwell times. Will stop effects if any are running.
- **Button Disabled** - no action is assigned to the button.
- **Solo** - plays back the content and suppresses any intensity values not provided by the associated content while the solo button is held down. When the button is released, intensity values are restored. Priority and HTP are ignored. Shielded, park and pixel mapping outputs are not affected by the solo button. This is unrelated to [Solo Mode](#).
- **Back** - fades to the previous cue.

## Fader Options

The following options are available for a playback fader:

- **Master** - fader will be a proportional master, a manual master, or an intensity master, depending on the cue list property.
- **Effect Rate** - fader centers to home. It controls the rate of any running effects (same behavior as using rate via the Effect Status Display). The adjusted setting from this control cannot be stored.
- **Effect Size** - similar to Effect Rate but for effect size.
- **Rate Master** - homes to center. It adjusts the cue rate, just like rate and load.
- **Down Fade** - same as the default behavior of the master option.
- **Fader Disabled** - no action is assigned to the fader.
- **Master Only** - fader is used to set a level for content to fade to. The slider can be used to live adjust levels when the fader has been activated via the bump button. See [Master Only \(on page 84\)](#) for more information.
- **Effect Master** - masters the entry/exit mode of the effects (size, rate or both).
- **Levels Only** - masters the levels without mastering the effect.

# Chapter 13

## Using Filters

---

About Filters .....	284
Record Filters .....	284
Partial Filters .....	284
Clearing Filters .....	285
Storing Data with Record Filters .....	285

## About Filters

Filters are used to determine which parameters can be stored to cues, palettes, and presets. The filter selection tool in the CIA affects record operations as long as the filters are set.



**Note:** Channel and parameter filters can be applied to faders and submasters. Those type of filters affect playback and not record functions.

---

## Record Filters

Record filters are used to select specific parameter data to store to record targets. When no filters are selected, all parameters can be stored, as appropriate to the **[Record]**, **[Record Only]**, and selective record action used.



**Note:** When storing show data, applied filters are highlighted and allow the associated parameters to be stored in record targets.

---



**Note:** When filters are deselected (not highlighted), they **prohibit** storing the associated parameters.

---



**Note:** There is no difference between having all filters selected and having no filters selected (default). In either state, all parameters are available for recording.

---

Record filters are applied from the CIA using the following buttons: **{Filter}**, the parameter buttons in the CIA, and the parameter category buttons.

The parameter category buttons can be used to select filters, as follows:

- Intensity (enables recording intensity data)
- Focus (enables recording pan and tilt)
- Color (enables recording color data)
- Beam (enables recording all beam data)

To apply record filters by category:

1. Press and hold **{Filter}**. The parameter buttons change to display filter selection.
2. Press the parameter category softkey **{Intensity/Focus/Color/Beam}** for the category you want to include in the record target. All parameters in that category will be highlighted and "Filter On" will appear above the softkey.
3. Release **{Filter}**. The buttons return to their normal appearance.

In subsequent record functions, only the filtered categories will be recorded. You may apply multiple category filters at once. Remember that applying all filters and no filters yields the same effect.

## Partial Filters

If you do not want an entire category to be recorded, you may apply parameter specific filters (partial filters) instead.

To apply partial filters:

1. Press and hold **{Filter}**. The parameter buttons change to display filter selection.
2. Press the parameter button (for example **{Zoom}**) for the parameter you want to include in the record target. That parameter will be highlighted and "Filter On" will appear above



the softkey.

3. Release **{Filter}**. The buttons return to their normal appearance.

In subsequent record functions, only the filtered parameters will be recorded. You may apply as many partial filters at once, as you wish. Any **unfiltered** parameters will not be included in record actions. In Live, unfiltered parameter data is displayed in its proper color, but a gray "N" (indicating null data) will appear in the upper right corner of the parameter's field.

## Clearing Filters

Applying filters is a toggle state. To clear any filter, simply repeat the application process described above. When pressed again, any applied filter will be removed.

**To clear all filters at once:**

1. Press and hold **{Filter}**. The parameter buttons change to display filter selection. **{Clear Filters}** appears in the upper left corner of the parameter buttons.
2. Press **{Clear Filters}**. Any applied filters will be removed and the highlights will turn off.
3. Release **{Filter}**. The buttons return to their normal appearance. All parameters are now available to record functions.

## Storing Data with Record Filters

If a record target is stored with filters in place, the filters allow only associated parameter data to be recorded in the target. Non-filtered data is not included when you record.

The various record targets are affected by filters in the following ways:

- **Palettes** - Palettes by definition are already filtered. The color and beam filters can be used to further modify what is stored in the color and beam palettes, however.
- **Presets** - Active filter settings impact what is stored in presets.
- **Cues** - Active filter settings impact what is stored in cues, even when using "record only" commands.
- **[Recall From]** - Recall from instructions are not affected by the filters.



# Chapter 14

## Working with Multiple Cue Lists

---

About Working With Multiple Cue Lists .....	288
Recording to a New Cue List .....	288
Using [Go To Cue] with Multiple Cue Lists .....	291

## About Working With Multiple Cue Lists

Eos provides many useful tools to allow you to work efficiently and simultaneously with multiple cue lists. These topics focus on the features and methods used when working with more than one cue list.



**Note:** *This feature is not available on Element 2.*

---

[Solo Mode](#) and [Cue List Properties](#) are topics covered in the Single Cue List chapter that are also useful when working with multiple cue lists. Additional information about working with a cue list can be found in [About Single Cue List \(on page 250\)](#).

Partitions can be especially useful when working with multiple cue lists. See [About Partitioned Control \(on page 438\)](#) for more information.

### Recording to a New Cue List

When recording cues, cue list 1 is initially used as the default cue list. Cue list 1 is displayed with only the cue number. It does not have a lead cue list number or a "/". To record to another cue list, that list must be specified. Cues will then be recorded to that cue list until another list is specified, or until the selected cue is changed in Live.

You may record up to 999 cue lists in an Eos show file.

The cue list that you are storing to is always determined by the selected cue, unless you specify a different cue list. The selected cue is displayed in the command line, in the PSD, and at the bottom of the Live/ Blind screen.

The selected cue is the last cue that you affected in Live. This includes a record, an update, a playback action such as **[Go]**, **[Back]**, a **[Go To Cue]** instruction, or simply changing a cue attribute.



**Note:** *It is very useful to keep an eye on the selected cue.*

---

Pressing **[Live]** will resync to the active cue.

### Using Record

**[Record]** will record all parameters of any channels that have non-home values to a specified cue.

To record to a new cue list press:

- **[Record] <Cue> [2] [/] [5] [Enter]** - this will create cue list 2 and will record the data to cue 5 in that cue list.

Any cues recorded after this will automatically record to cue list 2 until another cue list is specified or the selected cue changes the cue list number.

### Record Via Load

You can record a cue 1 to the next unused cue list by using the **[Load]** button for an unmapped fader. **[Record] [Cue] [Load]** will create a cue 1 in a new cue list and will map that cue list to the fader. Subsequent cues can also be recorded with **[Record] [Load]**, which will record to the next available cue within that cue list

## Using Record Only

[Record Only] can be used to create a new cue list instead of [Record]. [Record Only] stores only manual data to the specified cue.

To record to a new cue list press:

- [Record Only] <Cue> [2] [/] [5] [Enter] - this will create cue list 2 and will record all manual data to cue 5 in that cue list.

The cue list display will change to show only data from cue list 2. Any cues recorded after this will automatically record to cue list 2 until another cue list is specified or the selected cue changes the cue list.

## Make Manual

This softkey can be used to convert live cue or submaster data into manual values, allowing them to be included in the [Record Only] operation. Therefore data from other cues or lists can be selectively converted to manual data and then stored to another cue/list using [Record Only].

For more information on {Make Manual}, see [Using {Make Manual} \(on page 298\)](#).

## Using Assert

**Note:** There are two [Assert] buttons. This section uses the [Assert] button that is located in the main control keypad.

By default, channel parameters only respond to move instructions during playback. The [Assert] function allows tracked or blocked data from a cue to be replayed, even when another cue list has taken control of that channel/ parameter (see [Cue List Ownership \(on page 8\)](#)).

Assert can be applied to cues, cue parts, channels, channel parameters, or to entire cue lists. Asserted channels will play back their tracked and blocked values, regardless of cue list ownership, when the associated cue is replayed.

## At a Cue Level

When applied at a cue level, [Assert] ensures that **all** data in the cue, both moves and tracks, will be played back at their stored values.

To place an assert on a cue:

- [Cue] [x] [/] [y] [Assert] [Enter] - the cue will assert all of its channels upon playback. An "A" will be displayed in the "A" column of the cue attributes (cue index, playback status, and so on); indicating the cue has been asserted.

Assert can also be used from the command line to manually replay portions of a cue without having to replay the entire cue. Assert in this mode can only be used with cues that are currently active.

To place an assert on a portion of a cue:

- [Group] [6] [Assert] [Enter] - asserts the instructions for the channels in group 6 in cue 4.

This would then need to be stored using either [Record] or [Update].

## At a Cue List Level

When applied at the cue list level, [Assert] ensures that all values in all cues in that list are asserted on playback. When a cue list has been asserted, the playback status display will show an "A" in the assert column for every cue in that list.

To place an assert on a cue list:

- [Cue] [x] [/] [Assert] [Enter]

## At a Channel Level

When applied at a channel or parameter level, assert ensures that the entire channel or the specified parameter will be played back at its stored value.

To place an assert on a channel or group of channels:

1. [select channels] [Assert] [Enter] - a red "A" will appear next to all of the channels' parameters in the Live/ Blind display. This indicates the assert is placed, but not yet recorded to a cue.
2. [Record] <Cue> [x] [Enter] - the red "A" turns to blue in the Live/ Blind display, indicating the assert has been recorded. In the cue x row of the playback status display or the cue list index, a lower case 'a' appears in the "A" column, indicating that a partial assert is included in cue x.

You may also store this assert using [Update] or you can apply it in Blind.

To place an assert on specific parameters:

1. [select channels] {Intensity/Color/Focus/Beam} or {parameter buttons} [Assert] [Enter] - places an assert on the specific parameters of the selected channels.
2. [Record] <Cue> [x] [Enter] - the assert is recorded to cue x. In the cue x row of the Playback Status Display or Cue List Index, a lower case "a" appears in the "A" column, indicating that a partial assert is included in cue x.

Assert is a very useful tool allowing channels that have been seized by other cue lists to be repossessed by the associated cue list, while still allowing the asserted channel data to be treated as tracked instructions.

## Using Allfade

Allfade is a [cue attribute](#) that commands any intensity values on stage that are not provided by the associated cue to fade to zero intensity when the cue is played. The allfade will adhere to the downfade time of the associated cue.

This is useful in conjunction with [assert](#), so you can regain control of channels from other cue lists **and** fade other channels from that cue list out.



**Note:** Channels with tracked values in the associated cue will not fade out in response to an allfade. These tracked values are part of the associated cue and therefore will be played back.

---

To assign an allfade to a cue:

- [Record] <Cue> [2] [/] [5] {Attributes} {AF/MF} [Enter] - records cue 2/5 as an allfade cue, thereby forcing any channels not in the cue to fade to zero on playback.

Like many other cue attributes, allfade is a toggle state. To remove the allfade flag, specify the cue and press {Attributes} {AF/MF} [Enter].

For more information on allfade, see [AllFade \(on page 264\)](#)

## Changing the Active Cue List

The active cue list will be displayed in detail on the Playback Status Display and the Cue List Index.

This view is changed by the following actions:

- Recalling another cue list in the command line - **[Cue] [3] [/] [Enter]**
- Recording a cue to another cue list - **[Record] <Cue> [3] [/] [8] [Enter]**
- Playing back a cue from the fader of another cue list - press **[Go]** for the associated fader.



**Note:** The split Playback Status Display allows detail for two cue lists. Both or either of these can be locked. [Playback Status Display \(on page 60\)](#)

---



**Note:** For information on using out of sequence sync, {OOS Sync}, see [OOS Sync \(on page 265\)](#).

---

## Most Recently Activated Cue

Use **[Cue] [n] [/] [Enter]** to select the most recently activated cue from that cuelist. If there is no active cue from that list, the first cue in the cuelist will be used.

## Using [Go To Cue] with Multiple Cue Lists

**[Go To Cue]** defaults to the currently selected cue list. **[Go to Cue]** is a live function. It can not be used to change cues in blind. **[Go to Cue]** instructions can be executed from any operating mode, without returning to live.

By default, a Go to Cue instruction is an out-of-sequence cue and will follow the rules of such (see [Out-of-Sequence Cues \(on page 306\)](#)).

For examples of how to use **[Go To Cue]** in playback, please see [Go To Cue \(on page 307\)](#).

## Using Go To Cue 0

**[Go To Cue] [0]** is a command line instruction that resets all intensity values not owned by another fader to default, including any manual values that are not an override to another active fader value. **[Go To Cue] [0] [Enter]** also resets the selected cue list to the top of the list, with the first cue pending.

To **[Go To Cue] [0]** on another cue list, press:

- **[Go To Cue] [2] [/] [0] [Enter]**



**Note:** Eos has an added intensity parameter for LED fixtures, that by manufacturer default have only RGB parameters but no intensity parameter. With this added control, the LED fixture will respond to the **[Go To Cue] [0]** command.

---

Captured channels, priority values and values from other faders running a different cue list are not affected by a **[Go To Cue] [0]** command.

When **[Go To Cue] [0]** is executed, any intensity values owned by the associated cue will fade out, while all non-intensity parameters remain in the current state. A **[Go To Cue] [0]** instruction does not impact the input from other programmers using partitioned control, unless the channels/parameters are shared.

## **[Go To Cue 0] & [Load]**



**Note:** On Eos, the button is **[GoTo Q0]**.

---

The **[Go To Cue 0]** , located with the playback controls, in conjunction with a fader load button to send a specific cue list to cue 0. This action does not use the command line. On the desired fader, simply press:

- **[Go To Cue 0] & [Load]**

## Using Go To Cue Out

To reset all parameters to their default state (unless they are controlled by a submaster) and reset all cue lists that are loaded to faders so that the first cue of each list is pending, press:

- **[Go To Cue] [Out] [Enter]**



**Note:** The **[Go to Cue] [Out]** command will not affect a cue list that is in [Solo Mode](#) (on page 276)

---



# Chapter 15

## Advanced Manual Control

---

About Advanced Manual Control .....	294
Using [Copy To] .....	294
Using [Recall From] .....	295
Using {Make Null} .....	297
Using {Make Manual} .....	298
Using {Make Absolute} .....	299
Using [Capture] .....	299
Using [Query] .....	300
Using [Undo] .....	301

## About Advanced Manual Control

This section describes some advanced features for manual control functions. These features can save you valuable programming time.

For additional manual control functions, see [About Basic Manual Control \(on page 170\)](#).

### Using [Copy To]

[Copy To] allows you to copy all data from one channel to another, either within the current working mode or to a different record target. [Copy To] works much like [Recall From], but in the opposite direction, [Copy To] forces data **to** a channel from the selected channel, whereas [Recall From] pulls it **from** a channel to the selected channel. For information on using [Recall From], see [Using \[Recall From\] \(on the facing page\)](#)

By using the IFCB category buttons or parameter buttons, you may copy subsets of channel data. Entire cues, cue ranges and cue lists can be copied to other locations. To only copy over intensity and parameter levels, use the {Only Levels} softkey. This will exclude discrete timing information.

To copy over data from only active channels, use the {Only Active} softkey.

When referenced data is copied, if the copy target also has data in the reference that is being copied, the target will be placed in that reference (such as, color palette 1), at its stored values. If the copy target is not included in the reference, absolute data will be copied to the target, and not the reference.

Below are some examples of copy commands from record targets. This command is very versatile and the following list is far from exhaustive:

- [2] [Copy To] [Cue] [5] [Enter] - copies all information for channel 2 to cue 5.
- [2] [-] {Focus} [Copy To] [Cue] [5] [Enter] - copies all parameter data for channel 2, other than focus, to cue 5.
- [Group] [3] [Copy To] [Preset] [6] [Enter] - copies current information for group 3 to preset 6.
- [3] [Copy to] [6] [Cue] [8] [Enter] - copies the data from channel 3 to channel 6 in cue 8.
- [3] [Copy to] [4] [Thru] [9] [Enter] - copies the data from channel 3 to channels 4 through 9.
- [3] [Copy to] [8] [Cue] [2] [/] [1] [Cue Only/Track] [Enter] - copies the data from channel 3 to channel 8 in cue 2/1 and takes exception to the track/ cue only settings in regard to subsequent cues in cue list 2.
- [Cue] [2] [/] [Copy to] [Cue] [7] [/] [Enter] - copies all of the contents of cue list 2 to cue list 7.
- [Cue] [1] [/] [1] [Thru] [1] [0] [Copy To] [Cue] [5] [/] [5] [Enter] - copies cues 1 through 10 from cue list 1 to cue list 5, starting with cue 5.
- [1] [Copy To] [2] [0] {Only Levels} [Enter] - copies only the intensity and parameter information from channel 1 to channel 20.
- [1] [Copy To] {DMX} [2] - copies the DMX value from channel 1 to channel 2.
- [1] [Copy To] [2] {From Absolute} [Enter] - sets channel 2 to channel 1's absolute level.
- [1] [Copy To] {Live} [Enter] - copies channel 1's level to the live output.

In Live, you can use [Sneak] with [Copy To] to fade in the change.

### Example:

- [1][2] [Copy To] [2] [Sneak] <Time> 7 [Enter]

Copies the recorded data from channel 12 to channel 2 and sneaks it in 7 seconds.

Using the {HTP} softkey with [Copy To] will cause any intensity levels to be ignored if they are less than or equal to the copied value.

### Example:

Channels 1 and 2 are at 50% in cue 10, and in cue 11 channel 1 is at 10% and channel 2 is at full. If you are in cue 11, and use the syntax:

- [1] [Thru] [2] [Copy To] [Cue] [1][0] {HTP} [Enter]

Channel 1 will remain at 50% and channel 2 will go to full.

## Using Move To

While technically not a manual control instruction, **Move To** will be very useful when managing record target data stored from manual control.

When a **Move To** command is given, data is removed from its current location and moved to its new location. If the new location already contains data, a confirmation is required by Eos (unless disabled in Setup). See [Record Defaults \(on page 159\)](#). Existing data in the new location will be completely overwritten if a **Move To** command is confirmed.

Press [Copy To] [Copy To] to access **Move To**.

The following are examples of using **Move To**:

- [Color Palette] [1] Move To <Color Palette> [5] [Enter]
- [Preset] [3] Move To <Preset> [8] [Enter]
- [Cue] [9] Move To <Cue> [2] [Enter]
- [Snapshot] [4] Move To <Snapshot> [7] [Enter]
- [Preset] [1] Move To [Color Palette] [3] [Enter]
- [Int Palette] [5] Move To [Preset] [1] [0] [Enter]

When using **Move To** to convert a preset into a palette, all information not relevant for that palette will be removed.

## Copy To and Move To for Labels, Scenes, and Notes

The [Copy To] and Move To ([Copy To][Copy To]) commands can be used to copy or move labels between any target types that can have labels. A {Labels Only} softkey will display.

- [Sub] [1] [Copy To] [Sub] [3] {Labels Only} will copy submaster 1's label to submaster 3.

Labels, scenes, and notes can be copied or moved between cues. The {Labels Only}, {Scene Only}, and {Notes Only} softkeys will display.

- [Cue] [3] Move To [Cue] [6] {Notes Only} will move the note from cue 3 to cue 6.

## Using [Recall From]

[Recall From] is similar to [Copy To], except that it retrieves data from other locations, and can be used only for a channel list recalling from the same channel list but in a different location (for example, a cue). [Recall From] is essentially a "copy from" command. For information on using [Copy To], see [Using \[Copy To\] \(on the previous page\)](#)

All parameter data for selected channels will be recalled, or by using the IFCB category buttons or parameter buttons, you may recall subsets of channel data. To recall only levels and not effect, timing, mark or other non-level data, use the **{Only Levels}** softkey.

To recall data from only the active channels, use the **{Only Active}** softkey.



**Note:** The **{Only Levels}** and **{Only Active}** softkeys can be used with **[Recall From]** if no channel selection had been previously made.

In live, you can use **[Sneak]** with **[Recall From]** to fade in the change.

Below are some examples of recall commands from record targets:

- **[2] [Recall From] [Cue] [5] [Enter]** - recalls all recorded data from cue 5 for channel 2.
- **[2] [-] {Focus} [Recall From] [Cue] [5] [Enter]** - recalls all data for channel 2 from cue 5, except focus (pan/tilt - XYZ) data.
- **[Group] [3] {Color} {Focus} [Recall From] [Preset] [6] [Enter]** - recalls the color and focus information from preset 6 for the channels in group 3. Could also be used with a channel selection set instead of a group.
- **[Group] [3] {Color} [Recall From] [Cue] [7] {Make Absolute} [Enter]** - recalls color data for group 3 from cue 7 and breaks any references to record targets.
- **[2] [Recall From] [Sub] [4] [Enter]** - recalls all recorded parameter data from sub 4 for channel 2.
- **[Recall From] [Intensity Palette] [1]** - recalls all of the values stored in intensity palette 1.
- **[1][0] [Recall From] [Cue] [2] [Sneak] <Time> 7 [Enter]** - would recall the recorded data that cue 2 has for channel 10 and sneak it in 7 seconds when used in live.
- **[Recall From] [Cue] [1][0] {Only Active} [Enter]** - recalls data from only the active channels, which are those channels with intensities above 0, if no channel selection had been previously made.
- **[Recall From] [Cue] [2] [Enter]** - would result in a selection of the channels used in that cue and their values. Any channels that are used in the cue list but do not currently have an intensity in the recalled from cue will be set to zero. Pressing **[At]** afterwards would post a numeric list of those channels to the command line.

In Live or Blind, hitting **[Recall From] [Recall From]** will put **[Recall From] [Cue]** on the command line.

Using the **{HTP}** softkey with **[Recall From]** will cause any intensity levels to be ignored if they are less than or equal to the recalled value.

### Example:

Channels 1 and 2 are at 50% in cue 10, and in cue 11 channel 1 is at 10% and channel 2 is at full. If you are in cue 10, and use the syntax:

- **[Recall From] [Cue] [1][1] {HTP} [Enter]**

Channel 1 will remain at 50% and channel 2 will go to full.

## Recall From Park

You can use **[Recall From] [Park]** to set a channel or parameter to the same level as the current park value.

### Example:

Channels 1 through 5 are parked at 55. To recall that level to channels in live or blind, use the following syntax:

- [1] [Thru] [1][5] [Recall From] [Park] [Enter]

Channels 1 through 5 will be set to 55 and channels 6 through 15 will be unaffected.

For more information about using Park, see [About Park \(on page 350\)](#)



**Note:** *This does not release the Park buffer.*

## Using {Make Null}

The {Make Null} softkey can be used to withhold parameter data from record or update actions in live, and remove parameter data from record targets in Blind. {Make Null} is applied using channel selection and can impact entire channels, individual parameters, or parameter categories.

### Make Null In Live

When you apply a {Make Null} instruction to channels or parameters in Live, channel data is still visible onstage, but that data is essentially rendered invisible to record commands. Similar to filters (see [Record Filters \(on page 284\)](#)), {Make Null} acts as an “ignore” instruction in Live, not a remove instruction. When channel data is nulled, the values for that data in the live display turn grey and an “N” appears next to the data field.

{Make Null} differs from Park in that you can still manipulate data onstage (through manual control or through playback) but that data will be unavailable for record actions.

Some examples of using {Make Null} in Live are:

- [1] [Thru] [5] {Make Null} [Enter] - converts all parameters of channels 1 through 5 into null data.
- [2] {Color} {Make Null} [Enter] - changes only color data for channel 2 to null data.
- [9] [Thru] [5] {Pan} {Make Null} [Enter] - changes only the pan data for channels 5 through 9 to null.

Null instructions are lifted in two different ways. First, as {Make Null} is a toggle state, it is possible to reselect the channel and parameter followed by {Make Null} [Enter]. This lifts the null state.

Additionally, a [Go To Cue] instruction will remove the null state.

### Make Null In Blind

When applied in Blind, {Make Null} can be used to mask instructions in a cue **after** it has already been stored. A {Make Null} instruction can also be applied to channels/ parameters in palettes, presets, and submasters, thereby removing the data from the target entirely, in the same way that [At] [Enter] does.

When applied to channels/ parameters in cues, {Make Null} doesn't remove the data from the cue, it simply makes it unavailable for playback. It has the same effect on move instructions that it has on tracked values.

Some examples of using {Make Null} in Blind are:

- **[Color Palette] [1] [Enter] [3] {Magenta} {Make Null} [Enter]** - removes all magenta parameter data for channel 3 from color palette 1.
- **[Preset] [5] [Thru] [9] [Enter] {Intensity} {Make Null} [Enter]** - removes all intensity data for all channels in presets 5 through 9.
- **[Cue] [8] [Enter] [2] [Thru] [7] {Make Null} [Enter]** - nulls all data for channels 2 through 7 in cue 8.
- **[Cue] [9] [Enter] {Intensity} {Make Null} [Enter]** - nulls all intensity data for all channels in cue 9.

In the cue scenarios above, **{Make Null}** differs from using **[At] [Enter]** in that instead of allowing values established in previous cues to track in, **{Make Null}** both restricts the recorded data from playing back and prevents other values from tracking in. Therefore, if the cue were executed as an out-of-sequence cue or asserted, no data would play back or track in for any nulled values.

## Release

Release is an extension of the **{Make Null}** command in Blind. When Release is used, it behaves like Make Null, but it also releases the channel and parameter data to its background state, if one is available, or fades out the intensity instead.

Release can be used to mask instructions in a cue after it has already been stored. The data is not removed from the cue.

Release is applied in Blind by using the **{Release}** softkey or by using the **[Release]** hardkey.

- **[Cue] [3] [Enter] [2] {Release} [Enter]** - releases all data for channel 2 in cue 3.
- **[Cue] [2] [Enter] [3] {Color} {Release}** - releases the color data for channel 3 in cue 2.



**Note:** *Release tracks forward through a cue list until the Release command is removed or a move instruction happens.*

When release has been applied, the released content will display in gray with a R in Blind.

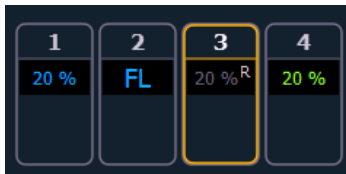

A Release flag will also appear in the Playback Status Display and the Cue List Index.

## Using {Make Manual}

The **{Make Manual}** softkey can be used to convert cue or submaster data into manual values, allowing it to be included in **[Record]**, **[Record Only]**, and **[Update]** operations.

- **[5] {Make Manual} [Enter]** - selects channel 5 and makes all of its current parameter settings manual data.
- **[8] {Focus} {Make Manual} [Enter]** - selects channel 5 and makes all of its focus data manual.
- **[9] [Thru] [3] {Color} {Intensity} {Make Manual} [Enter]** - selects channels 3 through 9 and makes their color and intensity values manual.

## Using {Make Absolute}

Referenced data can be transformed into absolute data using the **{Make Absolute}** softkey. This softkey is available in Live or Blind. Referenced data is channel/ parameter data that is derived from a palette or preset. **{Make Absolute}** can be used to leave a parameter unchanged, but break its palette or preset reference.

The following examples illustrate how to change referenced data into absolute data.

- **[4] {Make Absolute} [Enter]** - selects channel 4 and makes any referenced data for that channel absolute data.
- **[7] {Color} {Make Absolute} [Enter]** - selects channel 7 and makes its color data absolute.
- **[3] [Thru] [9] {Color} {Intensity} {Make Absolute} [Enter]** - selects channels 3 through 9 and makes their color and intensity data absolute.

In each of these examples, the channel display will change to show the result of the command. Wherever the reference was previously indicated (IP, FP, CP, BP, Pr), an absolute value (numerical) will be seen.

In Live, data that is changed to absolute is also made manual, thereby requiring a record or update instruction if the results are to be maintained.

**{Make Absolute}** can also be used in conjunction with an update command, allowing a cue to be updated while also breaking the reference to palettes or presets that were manually modified.

### Example:

- **[Update] {Make Absolute} [Enter]**

Updates the active record target. Any manual values that were modifications to a palette or preset stored in the cue will be updated as absolute data in the cue. The reference will be discarded.

## Using [Capture]



**Note:** *This feature is not available on Element 2.*

Capture is a manual priority state. Any captured channel parameter data will be unaffected by playback, but will respond to manual control operations.

When channels are selected, **[Capture] [Enter]** captures all parameters of those channels. They will remain unavailable for playback or submaster override until they are released from the captured state. Capture is a toggle state, so to release parameters from a captured state, press **[Capture] [Enter]** again.

### Example:

- **[1] [Thru] [9] [At] [Full] [Capture] [Enter]**

A "C" is displayed next to the captured parameters (intensity) in the channel display. The selected channels are now captured and are unavailable for playback or submaster instructions until they are released from capture.

You may also capture specific parameters of a channel using the parameter buttons in the CIA.

### Example:

- [7] {Focus} [Capture] [Enter]

If a group of channels are selected, and some of those channels are captured and some are not, the first press of **[Capture]** releases all channels from the captured state and the second press captures all manual settings for the selected channels.

Uncaptured channels remain at their current values until restored to previous values or a new instruction is provided. You may restore channels to their background or default state using the **[Sneak] [Enter]** feature (see [Sneak \(on page 197\)](#)). Or you may leave them in a manual state until a new instruction is received.

It is also possible to latch capture on. This will automatically capture all manual changes as they are made. Pressing **[Capture] [Capture] [Enter]** automatically captures subsequent manual changes. The command line will read "Capture Enable " and the Capture hardkey will illuminate. To remove the capture latch, press **[Capture] [Capture] [Enter]** again.



**Note:** Capture Latch works on a user by user basis.

---

## Using [Query]

**[Query]** is used to select channels that meet criteria specified by you. These selections are conditional, based on what type of fixture a channel is or what that channel is doing, isn't doing, can do or cannot do. These criteria are established in the command line using the softkeys, the keypad, and the direct selects.

When **[Query]** is used, the following softkey conditions are available:

- Is In
- Isn't In
- Can Be
- Can't Be
- Or
- Moves Only
- Unpatched
- Mark (cue where the intensity is active)
- Less Than (includes equal to)
- Greater Than (includes equal to)
- Broken Mark
- Marking (future cue)
- Track
- Up Moves
- Down Moves
- Live Moves
- Dark Moves
- Autoblock
- Block
- Assert
- Part
- Park
- Time
- Delay
- Capture





**Note:** Unless otherwise specified, Eos assumes that a query will apply to current output. Therefore use of the **{Is In}** softkey is optional.

The CIA also repaints to display all of the available softkeys by which you can search. These can be used in defining your query criteria.

- **{Default}** - includes the query softkeys along with additional query conditions.
- **{Text}**
  - **{Keywords}** - displays buttons for all the text used in the text 1 through 10 fields and all of the default keywords in Patch.
  - **{Gel}** - displays all of the gels used in the current show file.
  - **{Text 1}** - **{Text 10}** - displays only the text used in that text field.
- **{Fixture Types}** - displays buttons for all of the fixture types used in the current show file.

See also [Renaming Text Fields in Patch \(on page 127\)](#) for more information.

As a query is defined in the command line, channels will be specified in the Live/ Blind display. When an **[Enter]** command is used to end the query, the remaining channels of the query will be selected.

### Example:

You wish to find channels which are in color palette 2 and have an intensity of 50%:

- **[Query] <Is In> [Color Palette] [2] [At] [5] [0] [Enter]**

In the Live/ Blind display, any channels meeting this criteria will be selected.

You may use **[Next]** and **[Last]** to cycle through the query selection, one channel at a time to control only a specific channel.

Other examples of using a query are:

- **[Query] {Isn't In} [Beam Palette] [2] [5] [Enter]**
- **[Query] {Accessory} {Can Be} [Color Palette] [8] [Enter]**
- **[Query] {Unpatched} [Delete] [Enter] [Enter]** (Only works while in Patch.)
- **[Query] {Fixture Type} {Revolution} {Can Be} [Focus Palette] [6] {Isn't In} [Cue] [4] [Thru] [9] [Enter]**
- **[Next] [Next] [Enter]** - selects one channel from the query result

Additionally, in Patch you can define up to ten query keywords for each channel. These keywords can be used to create a query condition as well (See [Adding Keywords in Patch \(on page 126\)](#)).

Keywords defined in Patch will appear in the CIA when **[Query]** is pressed. They can then be used in a query like this:

- **[Query] {Your keyword} {Can't Be} {Beam Palette 5} [Enter]**

Hardkeys on the facepanel, such as **[Time]** can also be used to construct a query.

## Using [Undo]

Undo is a method to reverse or "undo" certain operations performed in the software. You can use **[Undo]** to reverse any command that results in a change to data that would be saved to the show file or any command that changes manual levels in Live.

If there are any commands in the command line, pressing **[Undo]** once clears the command line. Once the command line is empty, pressing **[Undo]** will start the undo process.

When **[Undo]** is pressed from an empty command line, the command history display will open in the CIA and the most recent completed command is highlighted in gold. If you press **[Enter]**, you will undo your last command. **[Shift] & [Clear]** can be used to clear the command line as well.

Command History	
Mode	Command
LIVE	Record Preset 1
LIVE	Chan 1 Thru 15 @ Full
Patch Channel	Chan 27 Label worklight
Eos	[Fixture]
LIVE	Delete Preset 1
LIVE	Delete Cue 1 / 9

Commands to be undone.

You may use the page arrow keys or a mouse to select multiple commands. When **[Enter]** is pressed, an advisory is posted. When **[Enter]** is pressed again, all highlighted commands will be undone and subsequently removed from the command history. When removing more than one command, a confirmation is required.

After an Undo has been performed, a **{Redo}** button will appear in the command history. You may press this button followed by **[Enter]** and the last undo will be “redone” to reinstate the removed commands

In a multiple user environment, each user is only able to undo the changes that they made. In the undo command history, the user will only see the commands that they used.



**Note:** Not all commands can be undone including playback actions and manual attributes placed on channels or encoder actions.

## Command History

Command histories are kept for each editing session, which begins when:

- a console logs on to the network
- a new show file is loaded
- a show file is opened, merged, or imported

Each user builds an individual command history, specific to the commands **they** have entered.

You can open the command history at any time by pressing **[Displays] <More Sk> {Cmd History}**.



**Note:** Commands that do not affect manual input or record targets (loading a cue, running a cue, or moving a submaster) are not included in the command history.

Pressing **[Undo] [Undo]** will scroll to the most recent undo-able command in the command history display. To undo the command, press **[Enter]**.

# Chapter 16

## Cue Playback

---

About Cue Playback .....	304
Playback Controls .....	305
Selected Cue .....	305
Out-of-Sequence Cues .....	306
Virtual Faders .....	309
Assigning Faders .....	309
Displaying Fader Pages With Content .....	310
Changing Fader Pages .....	310
Playback Fader Controls .....	310

## About Cue Playback

Eos, Eos Ti, and Gio each have one master fader pair and 10 motorized faders with 100 pages for configurable cue lists, submasters, grand masters, IFCB Palette/ Presets lists, or individual instances. Gio @ 5 has one master fader pair and 5 motorized faders with 100 pages. Ion Xe has one master fader pair. Ion Xe 20 has one master fader pair and 20 faders with 100 pages. Element 2 has one master fader pair and 40 faders with 100 pages. You can define how each of the faders will function. There is no default setting for faders, which allows you the freedom to define each fader's function in the [fader configuration display](#) or you can configure them while programming, as the contents of those targets are stored.

**Note:** *Element 2's cue list cannot be assigned to a fader. It can only be loaded on the master playback fader pair.*

The master playback fader pair is located to the right of the motorized fader array, near the control keypad. The master is a split crossfader pair.

You cannot page the master fader as it is permanently paired and always available for use.

The two buttons beneath the master fader pair are **[Go]** and **[Stop/ Back]**. The **[Load]** button and playback display are located just above the faders.

**Note:** *On some consoles, the **[Load]** button for the master playback fader pair is actually labeled as **[Master]**.*

You can page the motorized faders using the **[Fader Page]** button alone, combined with the numeric keypad, or with the wheel directly below the **[Fader Page]** button. As pages are changed, the faders will reset to the last position they were in on the associated page. Also, each individual fader is provided with a **[Load]**, **[Go]**, and a **[Stop/Back]** button for operation and playback. These buttons behave differently when the fader is a submaster or grandmaster, and can be changed in the fader configuration display.

## Fader Display and Ribbon

On Element 2, this information is displayed in the fader status display. See [Indicators in the Element Fader Status Display \(on page 80\)](#)

The fader display is located on the bottom of the PSD, and the fader ribbon is located directly above the faders. Both areas provide information about each fader including the fader designation (S = submaster with the designation of the submaster number, L = playback with designation of the cue list and cue number that is loaded, GM = grandmaster, PR = preset with designation of the preset number, and IP, FP, BP, CP = palettes with designation of the palette number).

Each area uses the fader color coding that is used in the fader configuration tools.

Grandmasters and inhibitive submasters are in red, additive submasters are yellow, playback faders display in green, and presets and palettes are orange.

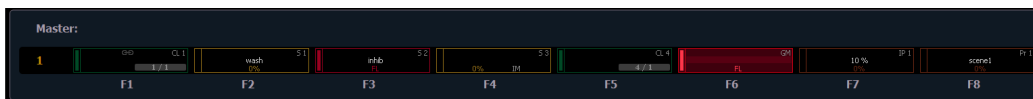

In the above screenshot, Fader 1 has discrete disabled. There is a link icon that displays to indicate that discrete is off. Fader 4 is set to an intensity master and is displaying an IM to indicate that.

## Playback Controls

It is important to familiarize yourself with the playback controls and their locations on your console.

Please see the appropriate console geography topic for more information:

- [Eos Ti Geography \(on page 12\)](#)
- [Eos Geography \(on page 13\)](#)
- [Gio Geography \(on page 14\)](#)
- [Gio@5 Geography \(on page 15\)](#)
- [Ion Xe Geography \(on page 16\)](#)
- [Element 2 Geography \(on page 18\)](#)

## Selected Cue

When in Live or Blind, if you press **[Live]** or **[Blind]** respectively, the selected cue will be the last executed cue. This cue will appear on the command line.

When working in Live, the selected cue is always the last cue you recorded, edited, updated or played back. When entering Blind for cues, the selected cue will be selected and displayed. Changing the selected cue in Blind will cause the playback status display to change as well, unless **preserve blind cue** has been enabled in **Setup**, which will not synchronize the Blind display to the currently selected cue but rather shows the last cue selected in Blind. When you return to Live, the selected cue is synchronized to the currently active cue.

The **attributes** of the selected cue (such as timing, attributes, label and external links) are shown at the bottom of the Live / Blind display.

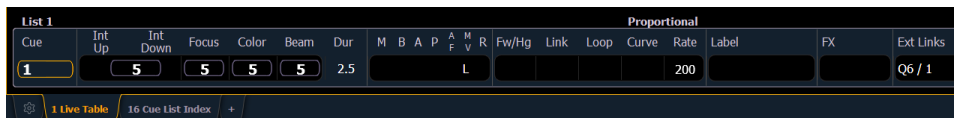

On Element 2, the display is slightly different.

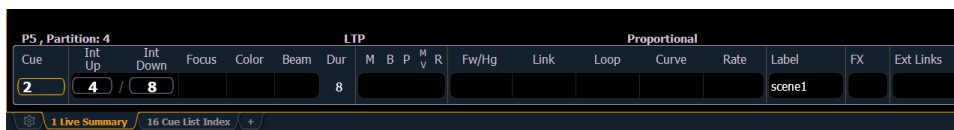

## In Live

To load a new cue to a fader, place the cue on the command line and press **[Load]** for the desired playback. When the **[Go]** button is pressed, the activated cue is the selected cue.

### Example:

Assume you have cue list 1 already loaded to the master playback faders. Now you want to load cue 2/1 to a fader.

- [Cue] [2] [/] [1] [Load]

If you press the [Load] button above the master playback fader, it will load cue 2/1 into the pending file. You could also press the [Load] button above any other playback fader to load the cue into that fader's pending file.

In this example, the last cue executed from cue list 1 is still the active cue, while cue 2/1 is pending. When [Go] is pressed, 2/1 will be executed.

You can also load cue list 2 by pressing [Cue] [2] [/] [Load]. This will load the first cue of list 2 into pending.

The selected cue is changed by go, record, or update instructions as well as cue modification and selecting a cue on the command line. When you execute a cue that has a follow or hang time, the next cue will become the selected cue when activated.

### In Blind

While in Blind, changing the selected cue will change the playback status display to show information surrounding that cue.



**CAUTION:** When editing in blind, changes to cues are automatically stored, therefore no update or record command is required.

While working in blind mode, cues can be executed in live using [Go], [Back], and [Go to Cue], but this does not change the cue you are working with in blind.

### Loading a Cue With Temporary Time

A cue can be loaded with a temporary time.



- [Cue] [3] [Time] [6] [Load] - loads cue 3 with the manual time of 6.



**Note:** For multipart cues, the temporary time will be applied to the entire cue, not just the part on the command line. For cues with discrete timing, its parameters will use the temporary time instead of the assigned discrete timing.

### Out-of-Sequence Cues

An out-of-sequence cue is any cue that is played back in one of the following ways:

- Cue is executed using a [Go To Cue] command. ([Go To Cue \(on the facing page\)](#))
- Cue is executed by a link instruction. ([Link/ Loop \(on page 258\)](#))
- Cue is loaded into a fader's pending file. ([Selected Cue \(on the previous page\)](#))
- Cue is re-executed using [Assert] & [Load] or is asserted from the command line. ([Using Assert \(Playback Button\) \(on page 312\)](#))

Generally, when an out-of-sequence cue is executed, the entire contents of the cue will be played back (move instructions **and** tracked values).

## Example:

Cue 1 sets channel 1 to full. That value is tracked forward until cue 10. The programmer plays back cue 1. She then sets channel 1's intensity to 50% manually. If she executes cue 2, channel 1 remains at 50%, as it is a channel parameter that is not receiving a move instruction from the incoming cue.

However, if she presses **[Go to Cue] [5] [Enter]** (an out-of-sequence execution), even though the value for channel 1 in Cue 5 is a tracked value, channel 1 will fade from the manual value of 50%, to full in the Go-to-cue time.

## Go To Cue

**[Go to Cue]** instructions can be executed from any operating mode. By default, a **[Go to Cue]** instruction is an out-of-sequence cue and will follow the rules of such (see [Out-of-Sequence Cues \(on the previous page\)](#)).

Following are examples of **[Go To Cue]**:

- **[Go To Cue] [5] [Enter]** - all parameters with values in cue 5 are faded to those values, even if they are tracked.
- **[Go to Cue] [6] [At] [5] [Enter]** - takes you to cue 6 at 50% of its fade completion. Hitting **[Go]** would finish the cue.
- **[Go To Cue] [Next] [Enter]** - takes you to the next cue in the active list.
- **[Go To Cue] [Last] [Enter]** - takes you to the previous cue in the active list.

When a **[Go To Cue]** instruction is executed, any null states applied with **{Make Null}** are removed. To maintain the make null setting, you should use **[Capture]** for the required channels. For more information, see [Using {Make Null} \(on page 297\)](#) and [Using \[Capture\] \(on page 299\)](#).

## Go To Cue Timing

**[Go To Cue]** uses go-to-cue timing established in **Setup Manual Control (on page 160)**. You can use a **[Go To Cue]** instruction with different timing options as follows:



**Note:** A cue can be loaded with a temporary timing. See [Loading a Cue With Temporary Time \(on the previous page\)](#).

- **[Go To Cue] [2] [Time] [1] [Enter]** - this command would take you to cue 2 in one second.
- **[Go To Cue] [3] [Time] [4] [/] [3] [Enter]** - this command would take you to cue 3 and all up fades and NP moves would have a time of four seconds and down fades of 3.
- **[Go to Cue] [Next] [Time] [3] [Enter]** - this command would take you to the next cue in the selected list in three seconds.
- **[Go to Cue] [Last] [Time] [2] [Enter]** - this command would take you to the previous cue in the selected list in two seconds.
- **[Go To Cue] [8] [Time] [Enter]** - this command would take you to cue 8 using all timing values stored in cue 8.

## Other Go To Cue Options

When **[Go to Cue]** is pressed, the softkeys in the CIA change to provide Go to Cue modifiers to enhance your playback ability.

From these softkeys, you can specify that when going to a cue, only some elements of that cue will be played back. Specifically you can choose to play back:

- Manual control using a fader
  - **[Go to Cue] [6] {Manual} [Enter]**
- Scenes opens the [Scenes \(on page 261\)](#) selection display.
  - **[Go To Cue] {Scenes}** - press or select a scene to go to that cue.
- Move instructions only
  - **[GoTo Cue] [3] {MovesOnly} [Enter]**
- Withhold any links (follow, hang, execute instructions)
  - **[GoTo Cue] [4] {MinusLinks} [Enter]**
- Use marks
  - **[GoTo Cue] [5] {Use Marks} [Enter]** - delays channels from marking until their intensities have reached zero.
- Complete a cue
  - **[Go To Cue] [4] {Complete} [Enter]** will go to cue 4 and if that cue has a follow/ hang, any following cues in the sequence will also fire. This may look like you are going straight to the last cue in the sequence but each cue will fire to make sure that any external links are fired.
  - **[Go To Cue] [2] [At] [5][0] {Complete} [Enter]** will go to cue 2 at 50% of its completion.
  - **[Go to Cue] [5] [Time] [Go to Cue]** will go to cue 5 using cue times, and append [Complete] to the command line.
- Single parameter channels only (conventionals)
  - **[GoTo Cue] [1] {SingleParam} [Enter]**
- Multiple parameter channels only (moving lights)
  - **[GoTo Cue] [2] {MultiParam} [Enter]**



**Note:** Double pressing **[Go To Cue]** will post **Go To Cue Complete** to the command line. You can then select the appropriate cue number and level of completion.

---

The following are additional modifiers that can be used with **[Go To Cue]**:

- Homes a cue list to its first cue
  - **[Go to Cue] [Home] [Enter]** homes the currently selected cue list to its first cue. **[Go to Cue] [x] [/] [Home] [Enter]** homes a cue list to its first cue.
- Takes a cue list to its last cue
  - **[Go to Cue] [Shift] [Home] [Enter]** homes the currently selected cue list to its last cue. **[Go to Cue] [x] [/] [Shift] [Home] [Enter]** will take you to the last cue in a cue list.
- Go to Cue Out
  - **[Go to Cue] [x] [/] [Out] [Enter]** allows you to use the **[Go to Cue] [Out]** command on a list specific basis. **[Go to Cue] [Out]** continues to affect all active cue lists.



**Note:** **[Go to Cue] [x] [/] [Out]** is similar to **[Go to Cue] [x] [/] [0]** except that any NPs on the fader will fade to their home level.

---

- Time
  - **[Go to Cue] [5] [Time] [Enter]** will go to cue 5 using cue times, and also uses any associated follow/hang times to automatically trigger the subsequent cue. To go to a cue in cue time, but not trigger the follow/hang, you would use **[Go to Cue] [5] {Minus Links} [Time] [Enter]**.





**Note:** If you want to specify a time or use the cue time, the **[Time]** command must always be entered after any other commands, such as **{Minus Links}** or **{SingleParam}**. The exception to this rule is **{Manual}**.

---

These can be combined within the command line as well:

- **[Go To Cue] [1] {MultiParam} {MovesOnly} [Enter]**

## Virtual Faders

You can have access to additional faders by using the virtual faders (see [Virtual Fader Module \(on page 85\)](#)).

## Assigning Faders

Cue playbacks, submasters, grandmasters, palettes, and presets are targets that can be assigned to faders.

**Note:** Element 2's cue list cannot be assigned to a fader. It can only be loaded on the master playback fader pair.

Faders can be assigned in a number of different ways.

- The [fader configuration](#) display
- The [fader list](#)
- The [cue list](#) index
- The [submaster](#) display
- Manually using the **[Load]** button

## With Auto Playback Enabled

Auto Playback is a record function enabled in **Setup>User>Record Default**, that automatically executes cues recorded in live on playback faders. When the cue is executed on the playback fader, any manual parameters involved in the record operation are automatically released to the cue and all other values stored in the cue are owned by that cue.

When the first cue is stored on Eos, the cue list of that cue automatically loads on the master fader. Any subsequent cue lists stored will load to the next available fader.

## Assigning Faders Manually

The location of playbacks, submasters, palettes, and presets on faders can also be defined as the contents of those targets are stored.



**Note:** You cannot define grandmasters in this manner, they must be defined in fader configuration display or the fader list. See [Grandmaster Configuration \(on page 82\)](#) for more information.

---



**Note:** Element 2's cue list cannot be assigned to a fader. It can only be loaded on the master playback fader pair.

---

If a fader is unmapped, a target can be loaded to that location by selecting the target from the command line and pressing the associated **[Load]** key. The fader will then be automatically assigned that target.

Once a cue list is loaded to a fader, storing to that cue list automatically plays the cue back on the appropriate fader, when [auto playback](#) on record is enabled in **Setup>User>Record Defaults**.

If a fader has been configured for default mapping ( see [Fader Configuration](#) for more information), the fader will receive its configuration from the Cue List Index. Changes made to a cue list in the cue list index will be shared with any default mapping faders loaded with that cue list. If changes are made to a fader set to default mapping in the fader configuration display, those changes will also happen in the Cue List Index. If set to Local, any changes made in the fader configuration display will impact only that instance of the content.

To load a new cue into the pending file of a playback fader, when auto playback is disabled in setup, or when you want to move a cue list to a different fader, first place that cue or list number on the command line then press the associated **[Load]** button for the destination playback fader.

- **[Cue] [4] [Load]** - changes the selected cue and loads it to the associated fader. This action assumes cue 4 is from the same cue list as is currently selected.
- **[Cue] [3] [/] [Load]** - changes the selected cue list and loads it to the associated fader.
- **[Cue] [5] [/] [6] [Load]** - changes the selected cue list and loads it to the associated fader with cue 6 as the pending cue.

## Displaying Fader Pages With Content



**Note:** This feature is not available on Element 2.

When using **[Fader Page]** or **[Shift] & [Fader Page]**, the displayed page will jump to the next page with content.

### Example:

Pages 1 through 3 and page 11 have content. If on page 2 you press **[Fader Page]**, you will see pages 3 then 11. After page 11, you will jump back to page 1.

When on page 11, as you press **[Shift] & [Fader Page]** you will see page 3.

## Changing Fader Pages

You can page through the 100 available pages of faders by pressing **[Fader Page]**, which will advance you one page for each press. To return to a previous page, press **[Shift] & [Fader Page]**. Or you can jump to a specific fader page by pressing **[Fader Page] & [page number]** on the keypad.

You can also scroll to a page by holding **[Fader Page]** and moving the rate wheel to increase/decrease the fader page number.

For consoles with motorized faders when fader pages are changed, the motorized faders assume the last position the faders were in on that page. This includes homing submasters to their required home position if needed.

On Element 2, you can page the faders by holding down the **{Page Subs}** softkey in the Live display. The bump buttons will light up in green, and the bump buttons that correspond to the currently selected pages will flash. Press the corresponding bump button to go to that page. The fader status display will change to show the fader pages. See [Paging Submasters \(on page 354\)](#) for more information.

## Playback Fader Controls

The following buttons are found in the Master Fader controls or in the Fader Page controls area of your console. See [Playback Controls \(on page 305\)](#)

The following controls are available:

- Load ([Selected Cue \(on page 305\)](#))
- Go ([Using \[Go\] \(below\)](#))
- Stop/ Back ([Using \[Stop/ Back\] \(below\)](#))
- Blackout ([Using Blackout and Grandmaster \(on the next page\)](#))
- Grandmaster ([Using Blackout and Grandmaster \(on the next page\)](#))
- Go To Cue 0 ([\[Go To Cue 0\] \(on the next page\)](#))
- Assert ([Using Assert \(Playback Button\) \(on the next page\)](#))
- Timing Disable ([Using Timing Disable \(on the next page\)](#))
- Freeze ([Using Freeze \(on page 313\)](#))
- Stop Effect ([Using Stop Effect \(on page 313\)](#))
- Rate Override ([Using Rate Override \(on page 313\)](#))
- Manual Override ([Manual Override \(on page 315\)](#))
- Off ([Releasing Content From a Fader \(on page 315\)](#))
- Release ([Releasing Content From a Fader \(on page 315\)](#))
- Fader Page ([Changing Fader Pages \(on the previous page\)](#))

## Using [Go]

The **[Go]** button is used to execute the cue currently in the pending file of the associated fader. When **[Go]** is pressed, all parameters assume their required positions in the recorded times, unless they have been recorded with manual timing. When a cue has manual timing values stored with it, the fader will set itself to zero when **[Go]** is pressed, or you may set the fader to zero before you press **[Go]**.

If a channel parameter is in a transition state when a new cue is activated on the same playback fader, that parameter will continue its initial instruction in its remaining time unless it receives a new move instruction in the incoming cue. If a new instruction is provided, the parameter will calculate its new target and the time to get there for a seamless course adjustment. If a parameter in transition has no new instruction in the incoming cue, it will continue its fade, using the original timing provided.

If a channel parameter is in a transition state when a new cue is activated on a different playback fader, and that parameter receives a move instruction, even if it is exactly the same instruction the parameter currently has, it will recalculate the destination and arrival time according to the information from the new cue.

For information on manual timing, see [Manual Timing Control \(on page 314\)](#) and for manual master, see [Master \(on page 279\)](#)

## Using [Stop/ Back]

All fader activity can be instantly stopped mid-transition by pressing the **[Stop/Back]** button for the required fader. To resume the cue, press the **[Go]** button. To fade to the previous cue on that fader, using default “back” timing, press the **[Stop/Back]** button again from this state.

When you have gone to the previous cue using the **[Stop/Back]** button, the cue should look just like it did before you hit the **[Go]** button, if the cue still has ownership of all of its channels. If a different cue list has taken ownership of some of the channel parameters within that cue in the interim, those specific channel parameters will not respond to the **[Stop/Back]** command.

If a cue is recorded or rerecorded when a fade is stopped, the contents of that fader will be recorded as absolute data in the new record target. If a cue is updated with the fader in a stopped state, all references in the cue will be updated accordingly.

When a cue on the playback fader is complete, pressing **[Stop/Back]** will step backwards sequentially through the cue list from that point. **[Stop/Back]** uses default back time as established in **Setup**, see [Manual Control \(on page 160\)](#). Or you can back into the previous cue using specific timing with **[Go to Cue] [Last] [Time] [n] [Enter]**.

## Using Blackout and Grandmaster

A grandmaster inhibits all live intensity values. If a grandmaster is set at 50%, all live intensities will be at 50% of their actual values.

On a physical fader that is configured to be a **grandmaster**, pressing the fader's **[Go] & [Stop/Back]** buttons at the same time will act as a blackout and inhibit all intensities to 0%. Pressing **[Go] & [Stop/Back]** again will exit blackout.

When a grandmaster or blackout are active, a grandmaster/ blackout warning will display at the top of all monitors. Clicking that will open a dialogue in the CIA.

## [Go To Cue 0]

**Note:** *On Eos, the button is [GoTo Q0].*

You can use the **[Go To Cue 0]** button, located with the playback controls, in conjunction with a fader load button, to send a specific cue list to cue 0. This action does not use the command line. Simply press:

- **[Go To Cue 0] & [Load]** for the desired fader

On Element 2, you can use the **[Go To Cue] [0] [Enter]** command to send the cue list to cue 0. This drives all cue intensities to zero, while leaving non-intensity parameters as currently set but no longer under cue control.

For more information on this action, see [Using Go To Cue 0 \(on page 291\)](#)

## Using Assert (Playback Button)

**Note:** *There are two [Assert] buttons. This section uses the [Assert] button that is located in the playback fader controls area.*

**Note:** *On Element 2, you will need to use the {Fader Control} softkey, which displays when [Live] is pressed.*

Use **[Assert] & [Load]** for the associated fader to re-run the active cue in that fader, following the same rules as **[Go To Cue]**. Assert can be used to regain control of all cue contents, apply a newly set priority state to the associated fader, or make any changes in blind to an active cue on stage.

When **[Assert] & [Load]** are used together, the entire contents of the cue are replayed. You can assert just certain elements of a cue by using the command line. See [Using Assert \(on page 289\)](#)

## Using Timing Disable

The **[Timing Disable]** button, used with **[Load]**, causes timing data to be ignored for any cues that are activated on the associated playback fader. When a playback fader is in timing disable mode, you will notice "TD" in the associated fader display, and the **[Timing Disable]** button will be red.

To release the playback fader from time disable mode, press **[Timing Disable] & [Load]** again. You can also cut the next cue in by pressing **[Timing Disable] & [Go]** or the last cue by pressing **[Timing Disable] & [Back]**.

On Element 2, you will need to press **[Live] {Fader Control}** to see **{Timing Disable}**.



**Note:** *[Shift] & [Go]* and *[Shift] & [Back]* can be used to cut to the next cue in the same way as *[Timing Disable] & [Go]* and *[Timing Disable] & [Back]*.

---

Cues will snap from move instruction to the next move instruction in a time of zero, which is the default time. To set a different time for Timing Disable, go to **Setup>User>Manual Control>Timing Disable**. See [Manual Control \(on page 160\)](#) for more information.

## Using Freeze

**[Freeze]** can be used to halt all effect activity on any active faders. To activate a freeze for only a specific fader, press **[Freeze] & [Load]**.

---



**Note:** *On Element 2, you will need to use the {Fader Control} softkey, which displays when [Live] is pressed.*

---

There are two ways to remove the freeze command:

- press **[Freeze] & [Load]** again for the specific faders to unfreeze the activity.
- press **[Assert] & [Load]** or **[Go]** or **[Stop/Back]** for the specific faders to resume the activity.

You may freeze and unfreeze effects from the command line.

- **[Effect] [2] [Freeze] [Enter]** - to freeze effect 2. Freezing a specific effect is different from stopping an effect. Freeze will stop the effect exactly where it is.
- **[Effect] [6] [Thru] [9] [Freeze] [Enter]** - to freeze a specified range of effects.
- When an effect is in freeze mode, you can use the same command to unfreeze:
- **[Effect] [2] [Freeze] [Enter]**
- **[Effect] [6] [Thru] [9] [Freeze] [Enter]**

## Using Stop Effect

The **[Stop Effect]** button can be used to stop all effects from operating on any or all faders, or it may be used with the control keypad to stop a specific effect.

- To stop all effects on a fader, press **[Stop Effect] & [Load]** of the associated fader.
- To stop a specific effect regardless of the fader it is operating on, press **[Stop Effect] [2] [Enter]**.
- To stop an effect on a specific channel, press **[5] [Stop Effect] [Enter]**.

When an effect is stopped, all impact of the effect is removed and the stage output is as though the effect has never been activated. This behavior is influenced by the exit behavior of the effect. See [Exit \(on page 328\)](#)

## Using Rate Override

To collect a playback fader for rate control, press **[Rate] & [Load]** for the required fader. When **[Rate]** is pressed without **[Load]**, it always collects the master fader for rate control. A subset of faders can be collected by pressing and holding **[Rate]** while pressing the **[Load]** button for the associated faders you would like to add.

Use the rate wheel to adjust the rate dynamically. The default is 100%, which is real time (example: 5 seconds = 5 seconds). Decrease the percentage to slow the cue down. Setting the rate to 0% will stop the cue. Increase the percentage to speed up the event.

On Element 2, press **[Live] {Fader Controls} {Rate}** to collect the master fader pair for rate control. Use the level wheel to adjust the rate dynamically. The default is 100%, which is real time (example: 5 seconds = 5 seconds). Decrease the percentage to slow the cue down. Setting the rate to 0% will stop the cue. Increase the percentage to speed up the event.

Following are some examples of rate:

- A 50% decrease rate applied to a 5 second event will play the cue in 10 seconds.
- A 200% increase rate applied to a 5 second event will play the cue in 2.5 seconds.

The top rate adjustment is 2000%. All timing values associated with a cue (including any follow or hang times) are affected by the rate modification proportionally.

If a cue is complete, any rate adjustment applied affects the cue in the pending file. When that cue is subsequently activated, the adjusted rate is used to direct timing. Pressing **[Rate]** again will turn rate control off and reset to 100%.

## Using Manual Control

There are four types of manual control for playbacks:

- Cues can be stored with manual timing. When cues have stored manual timing, the default behavior of the fader is to control those manual values.
- Cues can be captured for manual intensity control only. This is possible only when the associated cue has no manual timing values.
- Cues can be manually overridden using the **[Man Override] & [Load]** feature which captures all parameter transitions. On Element 2, you will need to press **[Live] {Fader Control}** to see **{Man Override}**.
- The fader can be set to manual master mode. See [Master \(on page 279\)](#) for more information.

In each of these cases, follow time counts down from **[Go]**. The hang time will be kicked off when the fader reaches full or when the last parameter reaches its end state from timing, whichever comes last.



**Note:** The [Fader Ribbon](#) and the [Fader Display Format](#) of the Playback Status Display are useful displays when using manual control. On Element 2, since playbacks cannot be assigned to faders, these displays are not available.

---

## Manual Timing Control

Manual timing can be set for any parameter or group of parameters. A fader is then used to control the progress of a transition.

### Example:

Assume the active cue contains an instruction to set red at 40 for channel 1.

The pending cue contains an instruction to set color for channel 1 to blue and the color parameter has a manual time. Press **[Go]** to activate the cue.

Channel 1 color does nothing.

As you move the fader up manually, channel 1 color moves proportionally from red to blue. Any parameters with timing will start their moves at the press of **[Go]** and be unaffected by the manual control.

To program a channel manual time:

- **[1] {Color} [Time] {Manual} [Enter]** - assigns a manual time to channel 1. This must be recorded or updated to a cue, when in Live.

Manual timing can also be set at a cue level:

- **[Record] [Cue] [5] [Time] {Manual} [Enter]**

Manual timing can also be set at a cue category level:

- **[Record] [Cue] [6] {Color} [Time] {Manual} [Enter]**

## **Manual Intensity Override**

An intensity transition may be taken over manually and the transition captured by dropping the fader down until it reaches the percentage of cue completion (i.e. if the cue is 50% complete, when the fader is manually dropped to 50%, the intensity transitions will be captured and the intensity portion of the cue completed by moving the fader manually between 50% and full or anywhere in between). If the fader is dropped below 50%, the fader will fade all intensity values proportionally from their captured values to their previous values.

If a fade is captured and the faders are not reset to 100% prior to the next press of the **[Go]** button, the fader will automatically reset to 100% upon cue execution. Alternatively, you can set the fader to 0% before executing the next cue to capture the cue for manual intensity control when the **[Go]** button is pressed if the fader is set to proportional control. Intensity control is released from the fader when the cue is considered complete (when the fader is brought back to 100%). If the fader is set as an Intensity Master, the intensity control is maintained, even when the cue has completed.

If a pending cue has any manual control properties, you may either preset the fader to zero or the console will automatically set the fader to zero when the **[Go]** button is pressed.

Manual intensity override is not possible if there is any manual timing in the cue, as the fader is already occupied with that control.

## **Manual Override**

Manual override allows the associated fader to control all parameters in a transition state on that fader. When **[Man Override] & [Load]** are pressed, all activity on that fader is frozen and the motorized faders move to match the current fade progression.

The fader is used to manually complete the cue transition for all parameters. If the fader is operating in a paired mode, the left fader controls the intensity upfade and all non-intensity parameters, while the right fader controls all intensity downfade actions. Manual control override automatically releases when the cue is complete.

A group of faders can be collected for manual override by pressing **[Man Override] & [Load]** (continue adding faders by pressing the associated **[Load]** buttons).

## **Releasing Content From a Fader**

There are a few ways to release content from a playback fader:

- **[Off] & [Load]** - returns control to the background fader, either a cue or a submaster, and stops any effects that are running on that fader. If there is no background value, the intensities will just fade out. On Element 2, press **{Fader Control}** to see **{Off}**.



**Note:** Associated pending and current cues will remain when using **[Off] & [Load]**.



**Note:** Pressing **[Go]** will run the cues in their current sequence.

---

- **[Release] & [Load]** - behaves like **[Off] & [Load]** except that it sets the pending cue to the first cue in the list and removes the active cue. On Element 2, press **{Fader Control}** to see **{Release}**.
- **[Shift] & [Load]** - behaves like **Release & [Load]** except that it additionally removes the content entirely from the fader. Pressing **[Shift] & [Load]** on an empty playback fader will unmap the fader.
- **[Escape] & [Load]** - unmaps all instances of the target (cue list, submaster, palette, or preset) on a selected fader.

The **[Go To Cue] [Out] [Enter]** command can be used to fade out all intensities, reset all cue lists to the top, and to clear out all background LTP fader values.



# Chapter 17

## Multipart Cues

---

About Multipart Cues .....	318
Record a Multipart Cue in Live .....	318
Storing a Multipart Cue in Blind .....	320
Deleting a Part from a Multipart Cue .....	321

## About Multipart Cues

Cues can be divided into up to 20 parts. Each part can have its own channels or parameters, levels, and timing information. Multipart cues can be stored in Live or Blind using the same conventions to record a standard cue.

There are three basic ways to create a multipart cue:

- Building a multipart cue part-by-part in Live
- Breaking an existing cue into multipart cues in Live
- Breaking an existing cue apart in Blind.

Multipart cues can be used to organize moving light data so that you can apply different times to different moves (focus moves slowly, but color snaps after a short delay). You can also use multipart cues instead of many individual cues triggered by wait times to create a series of fades.

A channel or parameter can only be provided an instruction once in a multipart cue. For example, it isn't possible to adjust color for channel 1 in cue 1 part 1 and then also provide a different instruction for channel 1 color in cue 1 part 8.

Default part timing is drawn from the cue level timing defaults established in **Setup** ( see [Cue Settings \(on page 151\)](#)); you may also assign discrete timing to channels in each part as you would for a single part cue.

## Record a Multipart Cue in Live

Storing a multipart cue in Live is accomplished in similar fashion to storing a single part cue. However, rather than storing the entire cue, you select and store just the channels that you want in each part.



**Note:** *There are a variety of different ways and different orders to go about creating a multipart cue. The examples in these topics represent some, but not all, of those ways.*

---

### Creating a New Multipart Cue in Live

There are two ways to create a multipart cue in Live. You can either build it part-by-part, or by building parts from the cue end state.

#### ***Build Part-By-Part***

Make desired changes to the stage state. If all of the changes that you have made are to go into a part, press:

- **[Record Only] [Cue] [2] [Part] [1] [Enter]**

Continue making changes and storing parts as you go.

#### ***Build Parts From Cue End State***

In most instances, you will create the end state of the cue and then break it into parts. To do this, you use selective storing commands, as follows:

- **[channel/parameter selection] [Record] (or [Record Only]) [n] [Part] [a] [Enter]**
- **[channel/parameter selection] [Record] (or [Record Only]) [Part] [b] [Enter]**

Each part can contain its own cue level timing and other attributes. Follow/Hang, Link and Loop, and Allfade commands can be placed at the cue level only - they cannot be placed on a part. Also, through the channel selection, you can put channel parameters into different parts.

Also, you can put channel parameters into different parts by including them after the channel selection but before the **[Record]** command.

- **[1] [Thru] [1] [0] {Focus} [Record] [Part] [3] [Enter]** - places pan and tilt parameters for channels 1 through 10 into part 3.

Part 1 of any multipart cue is where all unassigned move instructions will reside. Therefore, if the body of the cue (which is the normal behavior) is to be in part 1, you can simply select the channel/parameter list that you wish to place in parts 2 and higher.

## Setting Multipart Attributes and Flags

Cue attributes include [Follow](#), [Hang](#), [Link](#), [Loop](#), [Delay Time](#), [Rate](#), [Curve](#), [Cue Notes](#), [Cue Labels](#), and [Scenes](#). They are stored and function exactly as they do in single part cues.

Flags can be set for [Block](#), [Assert](#), [AllFade](#), [Mark](#), and [Preheat](#). Assert and AllFade are not available on Element 2.

For more information, see [Assigning Cue Attributes \(on page 257\)](#) and [Flags \(on page 263\)](#).

Cue part attributes can be defined as the parts are recorded, or they can be added after the part has been created.

### Example:

- **[Record] [Cue] [2] [Part] [1] [Delay] [8] [Enter]**
- **[Cue] [4] [Part] [3] {Color} [Time] [6] [Enter]**
- **[Cue] [8] [Part] [9] {AutoMark Off} [Enter]**
- **[Record Only] [Cue] [5] [Part] [2] [Assert] [Enter]**

## Using Update in Live for Multipart Cues

Updating a multipart cue is generally the same process as updating a single part cue, except you will provide a specific part cue number in the update command.

Various referenced data, such as palettes or presets, can be assigned to build a multipart cue. If you have made changes to referenced data within a multipart cue, thereby creating manual data, pressing **[Update] [Enter]** updates both the multipart cue and any referenced data with the new levels, as it does with single part cues.

You can update a part of a multipart cue with only selected parameters as well.

### Example:

You have written cue 1, which is a multipart cue and is active. Part 2 includes channels 1 through 5 referencing intensity palette 2 which is set at 25%. Select channels 1 through 5 and change the intensity value to 21%. The data in Live will indicate the new levels in red, and an "R" is displayed to indicate the reference has been broken.

To update cue 1 part 2, including the new intensity levels, breaking the reference to the intensity palette, press:

- **[1] [Thru] [5] {Make Absolute} [Enter]**
- **[Update] <Cue> <1> [Part] [2] [Enter]**

To update cue 1 part 2 **and** the referenced palette with the new levels:

- **[1] [Thru] [5] {Intensity} [Update] <Cue> <1> [Part] [2] [Enter]**

### Example:

When cue 2 is active, select channels 1 through 5 and set new levels for the color scrollers. Update only part 4 of the multipart cue 2 with the new scroller levels.

- [1] [Thru] [5] [Scroller] [Update] [Part] [4] [Enter]

## Storing a Multipart Cue in Blind



**CAUTION:** Edits in Blind take effect immediately, they do not require a [Record] or [Update] command.

## Changing a Single Part Cue to a Multipart Cue

When working in Blind, often you will be breaking a single part cue into a multipart cue.

It is quite possible to create a new cue in Blind and follow the exact same process, except in addition to pulling channel parameters into parts, you will also be providing them with move instructions or block commands. It is worth noting that tracked instructions do not belong to any specific part of a multipart cue.

Select the cue you wish to break apart and specify the first part you wish to create. Part 1 is generally where the body of the cue resides. Therefore, if you specify any part other than part 1, all of the move instructions in the cue are placed in part 1.

Begin by selecting any channels that you wish to move into some part other than part 1.

- [1] [Thru] [5] [Part] [2] [Enter]
- [6] [Thru] [1] [0] {Intensity} [Part] [3] [Enter]
- [6] [Thru] [1] [0] {Color} [Part] [4] [Enter]

As you create each part, that part is now selected. It is possible to select the channel parameter you want and press [Part] [Enter] to pull that data into the selected part.



**Note:** When breaking a cue into a multipart cue in blind, the [Part] button is a required instruction. Channel selection will not automatically assign a channel into a part. Use of the [Part] key allows you to add only specific channel parameters to the part. For example: [5] [Thru] [9] {Color} [Part] [Enter].

## Changing a Multipart Cue to a Standard Cue

To change a multipart cue to a standard cue, delete all of the parts of the cue.

### Example:

Cue 4 is a 3 part cue that include channels 1 through 20. To change cue 4 back to a standard single cue:

- [Delete] [Part] [1] [Thru] [3] [Enter]

## Creating Multiple Cue Parts in a Range

[Thru] [Thru] can be used in blind to create multiple cue parts in a range.

- [Cue] [1] [Part] [1] [Thru] [Thru] [4] [Enter] will create parts 1 through 4.

If you were to use just [Thru] instead of [Thru] [Thru], you would create parts 1 and 4.

## Deleting a Part from a Multipart Cue

When you delete parts of a multipart cue, any move instructions in the deleted part are moved to the first available part. If you want to delete move instructions out of a cue part, you have to select the channels and **[At]** **[Enter]** or null them.

- **[Delete]** **<Cue>** **[1]** **[Part]** **[1]** **[Enter]** **[Enter]**
- **[Delete]** **<Cue>** **[6]** **[Part]** **[1]** **[Cue Only/Track]** **[Enter]** **[Enter]**
- **[Delete]** **[Part]** **[1]** **[+]** **[2]** **[Enter]** **[Enter]**
- **[Delete]** **[Part]** **[1]** **[Thru]** **[3]** **[Enter]** **[Enter]**



# Chapter 18

## Creating and Using Effects

---

About Effects .....	324
The Effect List .....	324
Effects Editor .....	325
Effect Status Display .....	329
Effect Channel Display .....	331
Step Effects .....	332
Absolute Effects .....	335
Effect Background Value Modification .....	338
Beats Per Minute .....	338
Multiple Intensity HTP Effects .....	340
Relative Effects .....	340
Preprogrammed Rainbow Effects .....	342
Apply an Existing Effect .....	343
Editing Effects Live .....	343
Stop an Effect .....	343
Query and Group Effect .....	344
Using Offset .....	344
Replace With .....	344
Deleting an Effect .....	344
Recording an Effect to a Preset .....	344
Recording an Effect in a Cue .....	345
Effects on Faders .....	345
Delaying Effects .....	347

## About Effects

Effects are a method within Eos to provide dynamic, repetitive action to channels. This chapter explains the different types of effects, and how to use them.

Effects are manual control functions that can be applied to a channel parameter and then included in presets, cues, or submasters. Cues can contain both standard transitions for some channels/parameters and effects for the same or other channels/parameters.

Intensities can have different effects running at the same time but they must be from different sources. You can have an intensity effect running on a cue and those same channels can be impacted by an intensity effect on a submaster. See [Multiple Intensity HTP Effects \(on page 340\)](#)

Effects have user defined properties and attributes which are applied to the effects whenever they are used in cues. Effects also have cue level overrides, which allow you to use an effect in multiple locations, and modify its size, shape and/or rate in individual cues. See [Effect Channel Display \(on page 331\)](#) for more information.

Effects are broken up into three fundamental behavior types:

- **Step Effects** - are chases for one or more parameters. Intensity is the default. Step effects are On/ Off behavior. The ON value determines what the associated channel should do when the step is active, while the OFF value determines what the channel should do when the step is not active. See [Step Effects \(on page 332\)](#)
- **Absolute Effects** - are progressive behavior, rather than on/ off states of step effects. However, unlike relative effects, which are also progressive, you are determining exactly the behavior that you want to have for each transition in the effect. See [Absolute Effects \(on page 335\)](#)
- **Relative Effects** - are math based effects that provide a continuous offset from the current parameter value. There are three different types of relative effects: Focus, Linear and Color. See [Relative Effects \(on page 340\)](#)

There are four different displays for viewing and editing effects:

- **Effect List** - displays all of the recorded effects. See [The Effect List \(below\)](#)
- **Effect Editor** - displays in the CIA when the Effect List is open. The editor will display the attributes and properties of a selected effect for editing. See [Effects Editor \(on the facing page\)](#)
- **Effect Status** - displays information in the CIA about the currently running effects. See [Effect Status Display \(on page 329\)](#)
- **Effect Channels** - displays all of the channels in the currently running effects so you can override certain effect properties. The effect status display will also open while in the effect channel display. See [Effect Channel Display \(on page 331\)](#)

## The Effect List

At any time you may press **[Effect] [Effect]** or **[Tab] [1][3]** to view the effect list. Any recorded effects will be displayed here. The effect list is a blind view and any changes made in this view are automatically stored; a record command is not required.

You can also use the command line search to see a list of effect names while in live or blind. See [Command Line Search \(on page 32\)](#) for more information.

Notice that there are effects existing in this list prior to any being recorded. Effects 901-918 are preprogrammed relative effects that are automatically available to you (see [Relative Effects \(on page 340\)](#)).



To navigate this list use the navigation keys as described in [Display Control and Navigation \(on page 41\)](#) or select the effect number you wish to work with. Notice that when you select the effect list, the CIA changes to display the information for the currently selected effect.

Effect	Label	Type	Entry	Exit	Dur/Cyc	Scale
1	step based side lights	StepBased	Cascade	Immediate	Infinite	
2	Scroller Linear Effect	Linear	Immediate	Immediate	Infinite	16
3	Square	Focus	Immediate	Immediate	Infinite	29
4	Hue-Sat Fade	Color	Immediate	Immediate	Infinite	65
5	Absolute Mac 700 s	Absolute	N/A	N/A	Infinite	
6	int	StepBased	Cascade	Immediate	Infinite	
7	gobo chase	Linear	N/A	N/A	Infinite	37
8	movement	Focus	Immediate	Immediate	Infinite	78
9	color chase	Color	Immediate	Immediate	Infinite	48
10	Effect lead and drummer	Absolute	N/A	N/A	Infinite	
901	Circle	Focus	Immediate	Immediate	Infinite	25
902	Square	Focus	Immediate	Immediate	Infinite	25
903	Figure 8	Focus	Immediate	Immediate	Infinite	25
904	Can Can	Linear	Immediate	Immediate	Infinite	25
905	Triangle	Focus	Immediate	Immediate	Infinite	25
906	Spiral	Focus	Immediate	Immediate	Infinite	25

## Effect List Navigation

Using the [Next]/ [Last] keys will only move between effects in the effect list display. To navigate the effect editor, you will need to use the page arrow keys.

You can use [Page ◀] or [Page ▶] when in the effect list display to begin navigating in the effect editor. This only works for step or absolute effects. You can press [Escape] to return focus to the effect list display.

## Effects Editor

When viewing the effect list, the selected effect is displayed in the CIA. The effect properties/attributes are shown in categorized buttons in the CIA. To change any property/attribute, press the corresponding button and enter data as required.



**Note:** Some effect properties, such as rate and size, can only be modified in the [Effect Status Display](#) and in the [Effect Channel Display](#).

The properties display of the effects editor is shown below and definitions of properties follow:



## Type

Defines the effect type: step-based, absolute, or relative (linear, focus, or color). To change the type, press **{Type}** and then press the desired effect type in the buttons to the left.

- **<Effect> [1] {Type} {Step based} [Enter]**

## Scale

Applies only to relative effects. This modifies the amount the pattern is offset from the current parameter values. The scale is expressed as a percentage increase or decrease (25 = 25% of the programmed value).

- **{Scale} [3] [0] [Enter]** or you may adjust this using the “Scale” encoder.

## Cycle Time

Provides a cumulative time to complete one full iteration of an effect. In relative effects, the cycle time determines the length of time required for one channel to complete the cycle.

In absolute and step-based effects, the cycle time determines the time required to complete one full iteration of the effect. In these effect types, modifying the cycle time changes the timing values proportionally within the effect itself.

To change the cycle time, press **{Cycle Time}** and then enter the desired time (in minutes and seconds) from the keypad, followed by **[Enter]**. This can also be adjusted from the encoder.

## Duration/Cycle

This determines the length of time an effect will run. To specify, press **{Duration/Cycle}** and then choose the desired method from the buttons that appear to the left. The options are:

- **{Infinite}** - for step and absolute effects, the effect will run until the channel is provided a new instruction or the effect is stopped,. Relative effects with an infinite duration will run until a stop flag is applied.
- **{Duration}** - the effect will run for a set amount of time given in minutes and seconds. Enter the time from the keypad.
- **{Num cycles}** - the effect will run for a set number of iterations. Enter the number using the keypad.
- **{Duration/Cycles} {Num Cycles} [1] [0] [Enter]**

When an effect with duration is running in a cue, the effect will display in light blue while it is running and dark blue when it has finished. This is only displayed in the Live Summary View.



Light	Dark
Blue	Blue
When	When
Effect	Effect
is	has
Running	Finished

## Parameters

This allows you to select which parameters will be involved in the selected effect, by default. By entering a value here, you do not need to specify the required parameter when placing an effect on a channel group.

To add/ remove parameters to the effect, press **{Parameters}** and then select the desired parameters from the buttons that appear to the left.

- **{Parameters} {Iris} [Enter]**

## Attributes

These determine the basic behavior of the effect. Attributes include behaviors such as forward, reverse, bounce, positive, negative, and random grouping/ random rate. The attributes are slightly different between step, absolute, and relative effects.

- **Bounce** - effect will run first in forward, then in reverse. Subsequent passes alternate between forward and reverse.
- **Forward** - the effect will run in the programmed direction (the arrow on the pattern editor indicates "forward" for pattern effects, and step/ absolute effects will follow numerical order).
- **Reverse** - effect will run in the opposite direction of forward or reverse numerical direction. Forward and Reverse are mutually exclusive settings.
- **Random Group**- channel distribution or step order (depending on the type of effect) is applied in a continuously random fashion.
- **Random Rate** - This overrides the cycle time of the effect. Random Rate is applied in a range (for example 5 through 150).
- **Continuous Run** - the effect will keep running until there is a stop effect command. By default, **{Continuous Run}** is disabled for all step and absolute effects. It is enabled by default for relative effects. See [Assigning a Stop Effect Command \(on page 343\)](#) for more information.
- **Repeat on Go** - the effect will not restart unless **{Repeat on Go}** is used.
- **Build** - keeps values at their on-state, even when the step is no longer active.
- **Positive** - effect will run the steps (on state and off state) as programmed. Step effects only.
- **Negative** - inverts the on state and off state for the effect. Step effects only.
- **Break Mode** - mimics a scroll across a static background. All but the last action scroll one channel at a time across the selection. The final action appears on all channels not affected by the other actions. Absolute effects only.
- **Bounce Channels** - runs the effect on the channels first in forward, then in reverse.

Play with these behaviors to see how they alter your effect.

## Entry

Establishes at what time and how channels will enter the effect. To change the entry method press **{Entry}** and then choose a method from the buttons to the left. Entry modes vary by effect type. The options are:

- **{Cascade}** - channels enter the effect according to the trail and cycle time values (if applicable).
- **{Immediate}** - all channels enter the effect instantaneously.
- **{Fade by Size}** - The effect will achieve its full value as allowed by the pattern or step/absolute values using the In Time.
- **{Fade by Rate}** - increases the rate of the effect as it enters. If an effect submaster has an entry mode of **{Fade by Rate}**, the submaster will control the rate between 0 to 100.

- **{Fade by Size and Rate}** - the effect will achieve its full value as allowed by the pattern or step/absolute values and ramp up to full speed using the In Time.

## Exit

Establishes at what time and how channels will exit the effect. To change the exit method press **{Exit}** and then choose a method from the buttons to the left. Exit modes vary by effect type and how the effect is stopped. The options are:

- **{Fade by Size}** - when the effect is exited, values will return to their background state while still running using the exit time.
- **{Fade by Rate}** - decreases the rate of the effect as it exits.
- **{Fade by Size and Rate}** - when the effected is exited, channels will stop running the effect and return to their background state using the exit time.
- **{Stop and Fade}** - when the effected is exited, channels will stop running the effect and return to their background state using the exit time.
- **{Stop and Hold}** - when the effect is exited, channels will halt exactly where the effect left them.

## Time (Entry or Exit)

These fields establish the length of time for channels to enter/exit the effect. It can be entered in minutes and seconds from the keypad. These timing values are applied to the entry and exit modes. Cue level timing is the default for these. Press **{EnterTime} [Enter]** or **{Exit Time} [Enter]**. To reset to defaults, press **[Time] [Enter]**.

## Grouping

Grouping is used only in relative and absolute effects. This determines how channels currently running the effect will be grouped throughout the pattern. To change this press **{Grouping}** and then enter the number of lights you want grouped together.

Grouping defaults to **{Spread}**. This means that every light the effect is applied to will act as an individual element, moving through the effect sequentially based on the channel selection order, cycle time, and trail times. You can enter any number from 1 through 2000. A grouping of 2 means that every other light in the selection list when the effect is applied will move together through the effect. Grouping of three means every third light, and so on.

Your options are 1 through 84 or **{Spread}** which will distribute each channel in the effect evenly and treat it as a separate group.

- **{Grouping} [2]** - every other channel (in a range of channels) will be grouped when running the effect.

When an effect is applied to a group in live, that group is distributed by order, using this grouping function. If a group list is created and an effect applied, each group is considered an individual element within the effect.

## Trail

Trail is applicable to relative and absolute effects. Trail determines how channels are to follow each other through the effect; it is a percentage of the cycle time. Trail can be any value from 0-200%, even, or solo. The default is even. For example:

- **{Even}** - The groups will be distributed evenly throughout the pattern. This is calculated by dividing the cycle time of the effect by the number of groups of channels.
- **{10%}-{200%}** - When the first group is 10% through the effect, the second group will start the effect, and so on through the remaining groups. Therefore, the groups will trail n% behind each other, as a percentage of the cycle time.

- **{Solo}** - The first group will execute the entire pattern. When done, the second group will execute the entire pattern, and so on.

## Effect Editor Navigation

To navigate the effect editor, you will need to use the page arrow keys.

You can use **[Page ◀]** or **[Page ▶]** when in the effect list display to begin navigating in the effect editor. This only works for step or absolute effects. You can press **[Escape]** to return focus to the effect list display.

## Confirming Effect Changes

When using **[Page ▼]** to create a new effect step/ action in the Effects Editor display, you will first be asked to confirm the new step/ action number before continuing. This is to prevent new step/ action from being created by mistake.

## Using Encoders With the Effect Editor



**Note:** *This feature is not available on Element 2.*

---

When any effect is specified in the command line, the encoder display automatically repaints to display the following properties:

- Cycle Time - Default is 5 seconds for relative effects
- Scale
- Shape (Vertical or Horizontal as defined by the **{Mode}** button)
- Axis

At any time, you may use the encoders to adjust these properties within the effects editor for the specified effect.

## Effect Status Display

To view the effects currently running, you may press **[Displays]>{Effect Status}** to open the effect status display in the CIA.

This display shows you any currently running effects and gives you the ability to edit the effect while running. When an effect is selected, the encoders and encoder screen change to allow you to manipulate the effect according to rate, size, horizontal form, vertical form, and axis.

### Example:

To edit an effect, select the effect using the command line or select it directly from the CIA.

- **[Effect] [9] [0] [2] [Enter]**

The encoder screen and softkeys will repaint so that they now control the five attributes in the columns of the effect status display:

- **Rate** - modifies cycle time. Default is 100% and can be modified from 0%-2000%.
- **Size** - modifies scale. Default is 100% and can be modified from 0%-2000%.
- **Shape** (Vertical or Horizontal as defined by the **{Mode}** button) - Default is 100% and can be modified from 0%-2000%.
- **Axis** - Default is 0° and can be modified by +/- 180°.

Use the encoders or softkeys to adjust the effects while watching the effect on stage.

## Example:

Effect 1 is a step effect with the On State set to 50 and the Off State set to 10. If Size is set to 50, the On State will be set to 50% of 50 and the Off State will be 50% of 10. So On would be 25 and Off would be 5.

Effect	Source	Part	Channels	Delay	Rate	BPM	Size	HForm	VForm	Axis														
1	Cue 4	2	46>51		100		100																	
6	Man		01>04 71>73 81>89 91>98		100		100																	
<table border="1"> <thead> <tr> <th>Effect</th> <th>Attributes</th> <th>Duration</th> <th>Entry</th> <th>Exit</th> <th>Groupi...</th> <th>Trail</th> </tr> </thead> <tbody> <tr> <td>6</td> <td>Build</td> <td>Infinite</td> <td>Time 0 Fade by Size Cascade</td> <td>Time 0 Fade by Size</td> <td>Spread</td> <td>Solo</td> </tr> </tbody> </table>											Effect	Attributes	Duration	Entry	Exit	Groupi...	Trail	6	Build	Infinite	Time 0 Fade by Size Cascade	Time 0 Fade by Size	Spread	Solo
Effect	Attributes	Duration	Entry	Exit	Groupi...	Trail																		
6	Build	Infinite	Time 0 Fade by Size Cascade	Time 0 Fade by Size	Spread	Solo																		

The effect itself can be accessed for editing from this display by pressing **{Edit}** - any changes made directly in the effect status display are made to the effect itself and must be stored. Cue level overrides also must be stored or updated to the required cue, but do not impact the basic effect itself.

Effect attributes modified in the effect status display can be reset to their previous values using the softkeys:

- **{Rate} [Enter]** - resets the rate to the previous value.

The properties of an effect that can be modified at a cue or sub level will display at the bottom of the Effect Status display and in the [Effect Channel Display \(on the facing page\)](#) (which is access by pressing **[Shift] & [Effect]**). Click on a column to make changes from a list of available options.

Several color indicators are used in the Effect Status Display. Those colors and their meanings are:

- Grey - property is drawn directly from the effect.
- Red - property has been manually modified but not stored.
- Blue - property is an override to the saved effect.
- Magenta - property is tracking from a previous cue.

Clicking on the Attributes column will open the Effect Attribute Override display. From that display, you can access most of the same properties as those found in the Effect Editor. This display allows you to make modifications to properties, and store those modifications in a cue or submaster.



{Restart Effect} is an attribute that can only be accessed from this display. When enabled, {Restart Effect} will cause an effect to restart whenever the cue is fired. This attribute is applied to the cue that the effect is stored in and not in the effect itself.



**Note:** {Repeat on Go} is similar to {Restart Effect} but it is applied to the effect. For more information on {Repeat on Go}, see [Effects Editor \(on page 325\)](#).

## Effect Channel Display

In the Effect Channels Display, you can override certain effect properties per channel at the cue level. To open this display, press [Shift] + [Effect], [Tab] [8], or select the effect channel icon from the display management home screen.

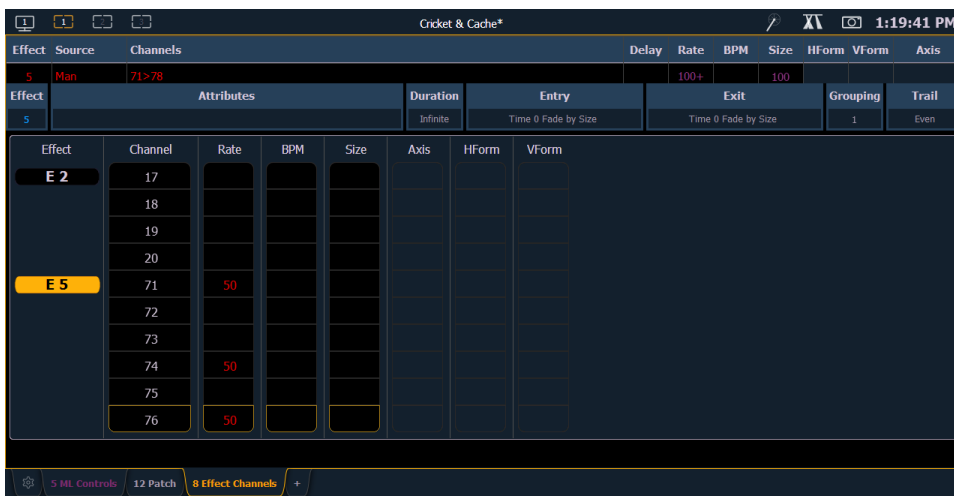

The following properties can be overridden:

- Rate
- BPM
- Size
- Axis (Focus Effects Only)
- H Form (Focus Effects Only)
- V Form (Focus Effects Only)



**Note:** To add a channel level override, first you will need to be in the Effect Channel display with the effect running.

[2][6]<Effect><1>[Rate][6][Enter] - to change the rate for just channel 26. With the effect running, the console will default to the running effect number. You may need to select the effect first ([Effect] [n] [Enter]). This will open the effect status display, and you will have access to the effect softkeys.

In the effect status display, an “+” will display by any effect property that has a channel level override.

You can then store these channel overrides in a cue by using [Record] or [Update].

## Step Effects

In step effects, each step contains an on-state and an off-state. The on-state is the action the channels in the step should take when the step is active. The off -state is the action the channels in the step should take when the step is not active. Step effects are a quick and easy way to build simple chases.

When building step effects, channels must be defined for each step. This is different from absolute and relative effects.

Once complete, you may play back the effect on all channels embedded in it by pressing [Recall From] [Effect] [x] [Enter]. Or you may specify only certain channels to play back from the embedded channel list.

A step effect is displayed in a chart with the following columns:

- **Step** - indicates the step numbers.
- **Channels** - displays the channel(s) in the step.
- **Param** - displays the parameter (if other than intensity) controlled by the step.
- **Step Time** - time from triggering the associated step to triggering the next step.
- **In Time** - the length of time for the channels to fade to the “on-state”.
- **Dwell Time** - the length of time the step remains in an “on-state”.
- **Decay Time** - the length of time it takes for the channels to fade to the “off-state”.
- **On State** - the parameter level (in%), or referenced data to be used for the on-state.
- **Off State** - the parameter level (in%) or referenced data to be used for the steps off-state. If you want the “off-state” to be the background state from playback, select the column and press [At] [Enter].

All times are entered from the keypad in minutes and seconds, tenths and hundredths.

Here is an example of a step effect when viewed in the CIA:



Step	Channels	Param	Step Time	In Time	Dwell Time	Decay Time	On State	Off State
1	26 36 46		0.3	0.3	0.3	0.3	100	(+) -30%
2	27 37 47		0.3	0.3	0.3	0.3	100	(+) -50%
3	28 38 48		0.3	0.3	0.3	0.3	100	(+) -50%
4	29 39 49		0.3	0.3	0.3	0.3	100	(+) -50%
5	30 40 50		0.3	0.3	0.3	0.3	100	(+) -50%
6	31 41 51		0.3	0.3	0.3	0.3	100	(+) -50%

**Effect 1 :step based side lights**

Type StepBased	Scale 1.0	Entry Cascade Fade by Size	Exit Immediate Fade by Size
Cycle Time 1.0	Duration Infinite	Time 0	Time 0
Parameters	Attributes Forward Positive		

Focus Palette Step
Color Palette In Time
Beam Palette On State
BPM InertBefore
Offset
Move To Properties
More SK

If an effect step is on the command line or indicated in the blue text to the left of the command line, entering a number on the command line will default to selecting a step for the current selected effect.

If no step is displayed, the command line will default to an effect number.

## Programming a Step Effect

Below is the process used to program a step effect.

## Example:

To open the effects list press:

- [Effect] [Effect]

Establish the number of the effect by pressing:

- <Effect> [1] [Enter]

The CIA will repaint with unpopulated fields for the new effect. Assign the effect as “step” by pressing:

- <Type> {StepBased}

The effect will appear in the list and the CIA will repaint with the default entries for the effect and a step chart for the effect. Define the number of steps by pressing:

- {Step} [1] [Thru] [6]

The steps will populate the chart and will remain selected. To make identical changes to all steps at once, you may now use the page arrow keys to navigate the chart. To make changes to only a single step, specify only one step in the command line, default values are drawn from the previous step.

After paging to the “Channels” column, specify the channels for the effect.

- [1] [Thru] [1] [2] [Enter]

Channels 1 through 12 will be broken up and distributed through the steps in the chart. Choose the parameter you would like in the effect by pressing:

- {Parameters} <Intensity> (Intensity is assumed unless another parameter is specified)

All steps are now intensity based. Use the page arrows to access the “Step time” column. Enter the desired step time:

- [1]

Page arrow to the Dwell Time (In time is left at 0) column and enter a dwell time:

- [1]

Page arrow to the Decay Time column and enter a decay time:

- [.] [2] [5]

Page arrow to the On State column and enter the on state percentage:

- [1] [0] [0]

Page arrow to the Off State column, or use the softkeys to go to the desired field, and enter the off state percentage:

- [5]

Adjust any of the effect details on the right side of the CIA by pressing the appropriate detail button and making changes (see [Effects Editor \(on page 325\)](#)).



**Note:** The cycle time is an aggregate of all of the timing in the effect and indicates how long it will take to make one full pass through the effect. If the cycle time is modified by the keypad or the encoder, it proportionally adjusts all of the timing within the effect.

## Range for On State and Off State

You can apply a range of levels to the on state and off state for the steps. You can either apply a range using the percentage or by using a palette.

### Example:

Using the above example, select steps 1 through 6.

- **{Steps} [1] [Thru] [6] [Enter]**

Page arrow to the On State column and enter the on state range:

- **[1][0] [Thru] [1][0][0]** - assigns the range starting at 10 and ending at 100 to steps 1 through 6. The range between 10 and 100 will be evenly divided between the available steps.

-or-

- **[Intensity Palette] [1] [Thru] [5]** - assigns intensity palettes 1 through 5 to the steps 1 through 6. Steps 1 through 5 will be assigned to palettes 1 through 5. Step 6 will be assigned to intensity palette 1. The range will wrap to fill any available steps.

## Inserting a Step

To insert a step anywhere in the effect, specify the step you wish the new step to be inserted before.

- **[Effect] [1] {Step} [4] {Insert} [Enter]** - Inserts a new step before step 4. If step four does not exist, it also creates the steps necessary to have "step 4" and then places a step ahead of it as well.

Inserted steps result in all succeeding steps to be bumped one place lower in the effect. In the above example, by inserting before step 4, step 4 would become step 5, step 5 would become 6 and so on. The inserted step would become the new step 4.

## Deleting a Step

To delete a step from a step-based effect, specify the effect in the command line and press delete:

- **[Effect] [1] {Step} [4] [Delete] [Enter] [Enter]**
- **[Effect] [1] {Step} [4] [Thru] [8] [Delete] [Enter] [Enter]**

## Absolute Effects

Absolute effects are a listing of sequential actions that channels are to take. They differ from step effects in that there is no on/ off state, rather they define progressive behavior from one action, to the next, to the next, and so on. The best example of this is that palettes and presets can be used as actions in absolute effects.

Absolute effects differ from relative effects (which are also progressive) in that you are specifying exactly what actions you want the lights to take, rather than mathematical offsets from the current state (relative effects).

Absolute effects also do not contain an embedded channel list. Therefore, the effect must be applied to channels in order to be played back.

Absolute effects are displayed in a chart with the following columns:

- **Action** - displays the action number.
- **Param** - displays the parameter (if other than intensity) controlled by the action.
- **Step Time** -time from triggering the associated action to triggering the next action.
- **Time** - the time for the action to fade in.
- **Dwell** - the duration of the action before moving to the next action.
- **Level** - indicates either the level of the parameter specified in the effect, or the referenced value for the channel(s) to perform (Palette or preset as defined in the command line).

Action	Param	Step Time	Time	Dwell	Level
1		(1.5)	1	0.5	FP 9
2		(1.5)	1	0.5	FP 1
3		(1.5)	1	0.5	CP 1
4		(1.5)	1	0.5	FP 2
5		(1.5)	1	0.5	CP 2
6		(1.5)	1	0.5	FP 1
7		(1.5)	1	0.5	FP 1

Effect 5 ;Absolute Mac 700 s			
Type	Scale	Entry	Exit
Absolute		N/A	N/A
Cycle Time	Duration	Fade by Size	Fade by Size
10.5	Infinite		
Parameters	Attributes	Time	Time
	Forward	0	0
		Grouping	Trail
		1	Even

In the above image, actions 1 through 7 indicate referenced values in the “Level” column (palettes or presets), though these values can be absolute data as well.

If an effect action is on the command line or indicated in the blue text to the left of the command line, entering a number on the command line will default to selecting a action for the previous selected effect.

If no action is displayed, the command line will default to an effect number.

Default step times will display in gray and in parentheses, and assigned step times will display in white without parentheses.



**Note:** *The default step time is the time value plus the dwell value.*

If no step time has been assigned, the action will begin once the fade and dwell times for the previous action have completed. If a step time has been assigned, the next action will begin after that set amount of time has elapsed.

You can also define specific parameters for Absolute effect actions. To apply a parameter to a specific action, click in the Param column and select the desired parameter.

## Programming an Absolute Effect

Below is the process used to program an absolute effect.

## Example:

To open the effects list press:

- **[Effect] [Effect]**

Establish the number of the effect by pressing:

- **[Effect] [8] [Enter]**

The CIA will repaint with unpopulated fields for the new effect. Assign the effect as absolute by pressing:

- **<Type> {Absolute}**

The effect will appear in the list and the CIA will repaint with the default entries for the effect and an action chart for the effect. Define the first action by pressing:

- **{Action} [1] [Enter]**

The action will populate the chart and will remain selected. You can also create a range of actions at once, using the **[Thru]** button, if desired. Use the page keys to navigate to the different columns

After arrowing to the "Time" column (or using the softkeys), specify the fade in time for the actions.

- **[5] [Enter]**

Page arrow to the Dwell column and enter a dwell time:

- **[5] [Enter]**

Page arrow to the Level column and enter the desired referenced target:

- **[Color Palette] [5]**

Page arrow down and a new action will be created. All fields default to the values in the previous action. Page to the next action in the Level column and enter the referenced target:

- **{Color Palette 8}**

Page arrow down to the next action in the Level column and enter the referenced target:

- **[Color Palette] [2]**

Page arrow down to the next action in the Level column and enter the referenced target:

- **{Color Palette 4}**

Adjust any of the effect details on the right side of the CIA by pressing the appropriate detail button and making changes (see [Effects Editor \(on page 325\)](#)).

## ***Range for Level***

You can apply a range of levels to the actions. You can either apply a range using the percentage or by using a palette.

### Example:

Using the above example, select actions 1 through 6.

- **{Actions} [1] [Thru] [6] [Enter]**

Page arrow to the level column and enter the range:

- **[1][0] [Thru] [1][0][0]** - assigns the range starting at 10 and ending at 100 to actions 1 through 6. The range between 10 and 100 will be evenly divided between the available actions.

-or-

- **[Color Palette] [1] [Thru] [3]** - assigns color palettes 1 through 3 to the actions 1 through 6. Actions 1 through 3 will be assigned to palettes 1 through 3. Action 4 will be assigned to color palette 1. The range will wrap to fill any available actions.

## Effect Background Value Modification

For Step and Absolute effects, you can use **[+]**, **[-]**, and **[/]** to adjust the background value .



**Note:** When using **[-]**, you will need to preface the command with **[+]** if you want to remove from the current value.



**Note:** **[/]** is used to scale the value by a percentage. See the example below.

### Example:

- Effect 1 is a step effect with the on state set to 100 and the off state set to - 50% for all steps. To set the step off state to -50%, you would use the following syntax **[Effect][1] [Step] [1] {Offstate} [+ ] [-] [/] [5] <0> [Enter]**. If the channels in the effect have a background value of 50, the off state for each step would be 25.
- Effect 2 is an absolute effect. To set a level at + 20 of the background, you would use the following syntax, **[Effect][2] {Action} [1] {Level} [+ ] [2]<0> [Enter]**. If the channels in the effect have a background value of 50, the level 1 in the effect would be at 70.

## Beats Per Minute

For step-based and absolute effects, you can set a beats per minute (BPM). For step-based effects, BPM affects the Step, In, Dwell, and Decay times, and for absolute effects, this affects the time/ dwell. Note that BPM impacts the effect directly.

There are two different ways for assigning BPM to effects:

### Directly setting BPM

If you know the BPM, you can assign that directly to the effect by using the **{BPM}** softkey, which is available when in the effect editor display.

- **[Effect] [1] {BPM} [1][9][0] [Enter]** - sets the BPM of effect 1 to 190. The step times will be adjusted for step-based effects, or the time/ dwell will be adjusted for absolute effects.

The BPM will display on the right side of the effect editor beside the effect number/ label. Editing the cycle time, the step time for a step-based effect, or the time/ dwell for an absolute effect will remove the BPM.

## Learning BPM

If you don't know the desired BPM, you can learn the BPM.

From Live, with the effect running:

- **[Effect] [1] [Learn] [Time]** - posts Effect 1 Learn Time Sample BPM to the command line, and opens the effect editor display.

While in this mode, press **[Enter]** to establish the BPM. The console will use an average of the last three times you press **[Enter]** in this mode to calculate the BPM. Pressing **[Learn]** again will stop this mode.

In this mode, every time the BPM changes, a live running effect will be modified accordingly without stopping.

## Learning Discrete Step Time

In learning discrete step time mode, every time you press **[Enter]**, the time since the last press of **[Enter]** is used to set the next step's step time for a step-based effect, or the next step's fade/ dwell time of an absolute effect.

- **[Effect] [1] [Learn] [Time] [Time]** - posts Effect 1 Learn Time Discrete Steps to the command line, and opens the effect editor display.

Pressing **[Learn]** again will stop this mode.

Instead of pressing **[Enter]**, you can press **[At]** while in this mode to add new steps to the end of the effect. Pressing **[Enter]** will send you back to the first step in the effect.

## BPM as a Cue Level Override

BPM can be applied to an effect or individual channels as only a cue level override in Live and Blind. As a cue level override, the effect step/ action times will not be affected.



**Note:** *The effect editor cannot be open when applying a cue level override. The effect status display does need to be open though. You can open the effect status display from the home screen or by pressing **[Effect]** while in live.*

---

With an effect recorded into a cue and playing back in live, **[Effect] [1] {BPM} [3][0] [Enter]** will change the BPM of the effect running. This change will happen immediately but the step or action times will not change. You can see the BPM value, which will be in red, in the Effect Status display.

When the cue is updated or recorded with the new BPM, an "\*" will appear next to the effect number in the Ext Links column of the PSD and the cue list. The BPM value in the effect status display will now be displayed in blue.

**[1] [Effect] [1] {BPM} [3][0] [Enter]** will only change the BPM for channel 1. A "+" will display in the BPM column of the effect status display, and the BPM will display in red in the effect channel display.

Once the cue is updated or recorded, the BPM will display in blue in the effect channel display. The "+" will still be displayed in the effect status display, and an "\*" will appear next to the effect number in the Ext Links column of the PSD and the cue list.

## Multiple Intensity HTP Effects

Multiple intensity HTP effects are either step or absolute effects running on HTP submasters or cue lists. For multiple intensity HTP effects to run correctly, they must be recorded and played back from different sources.

For example, you create three separate step effects. Each effect impacts the same channels. For the three separate effects to run correctly you need to record them to three separate effect submasters or cues in separate cue lists. Either method will allow for each effect to run together according to the rules of HTP. But, for example, if you were to have three separate effects running on three separate effects submasters and you try to record that into one cue, the cue will only run the effects that were currently at the highest level at the moment of the record.

## Relative Effects

A relative effect is an offset from the current state of a channel parameter. There are three different types of relative effects: [Focus Effects \(below\)](#), [Color Effects \(on the facing page\)](#), and [Linear Effects \(on the facing page\)](#). Each of these effect types have a graphic editor designed specifically for the parameters involved.

Relative effects have many of the same properties and attributes as step-based and absolute effects.

Eos is preprogrammed with 16 relative effects which represent some of the most commonly used patterns and parameters. These are automatically visible in the effects list and can be manipulated using the encoders to conform to your needs. You may also custom build relative effects.



**Note:** As you learn to use the effects editor with relative effects, it is recommended that you experiment with the preprogrammed effects until you understand the fundamentals and how effects can be altered.

## Focus Effects

Focus effects are designed to impact a channel's pan and tilt parameters. These are represented in the horizontal and vertical axes of the graph in the effects editor. They can be created from live or blind and the properties can be set in the effects editor as any other effect (see [Effects Editor \(on page 325\)](#)).

New focus effects default to a circle. You can clear this and draw your own shape by pressing **{Edit}>{Clear}** and drawing on the graph with your finger or the mouse. Press **{Apply}** when you are done. Other pre-made focus effects can be modified in the same manner. The green arrow indicates default direction of motion, which can be modified in attributes.

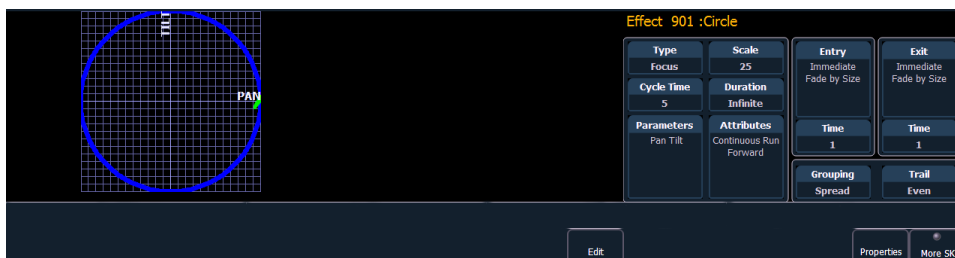

When adjusting the form of a focus effect, you can hold down **[Shift]** while using the horizontal encoder to change the vertical form.



## Color Effects

Color effects impact only color parameters. Hue and saturation offsets can be used which are represented in the horizontal and vertical axes of the graph in the effects editor. The **{Parameters}** key within a color effect displays the various color mechanisms used in any patched channels.

New color effects default to a circle. You can clear this and draw your own shape by pressing **{Edit}>{Clear}** and drawing on the graph with your finger or the mouse. Press **{Apply}** when you are done. Other pre-made color effects can be modified in the same manner. The green arrow indicates default direction of color shift, which can be modified in attributes.

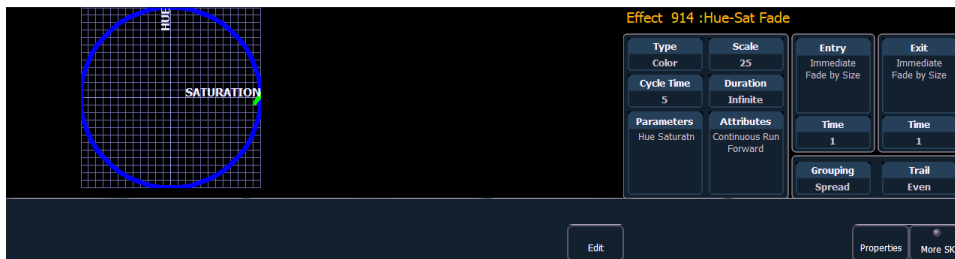

## Linear Effects

A linear effect does not have to be parameter specific. Rather it can simply be a reference to a linear diagram which can be applied to any parameter. You can redraw the linear diagram for an existing linear effect by pressing **{Edit}>{Clear}** and then tracing the diagram on the graph with the mouse or your finger. Press **{Apply}** when you are done.

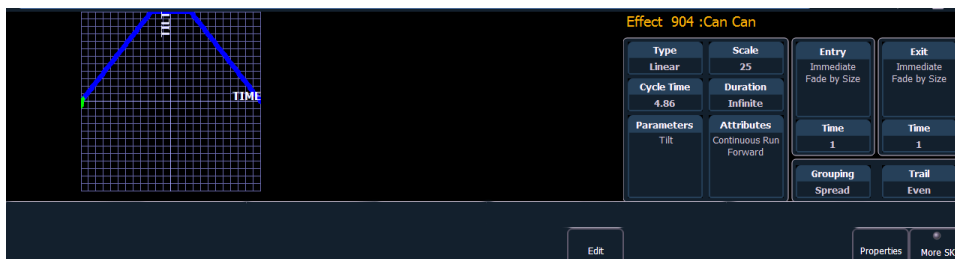

## Define a Pattern Shape

Shapes can be defined for any relative effect (focus, color, or linear). You can either draw a pattern from scratch or use one of preexisting patterns as a starting point.

To define a shape, press the **{Edit}** softkey beneath the pattern editor. The softkeys will change to **{Apply}**, **{Restore}**, **{Clear}**.

1. Press **{Clear}** to clear the pattern.
2. Draw a new pattern using your finger (or the mouse), or select a preexisting pattern. If you want to return to the original pattern, press **{Restore}** before pressing apply.
3. When you have the proper pattern drawn, press **{Apply}**. The pattern will be applied to the effect.



**Note:** If you delete a preprogrammed effect (for example, after making changes to it) the effect will return to its default value. You can also copy effects to another effect location and modify them from there. This will leave the original effect untouched.

- **[Effect] [904] [Copy To] [8] [Enter]**

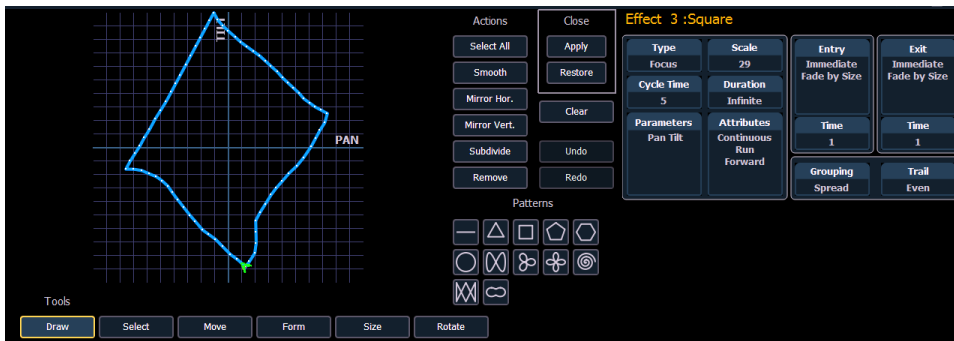

The following tools are also available to edit the curve with the mouse or touchscreen:

- **Draw** - draw a new line for linear effects or append points to focus effects
- **Select** - select points of the curve (if no points are selected, all are changed)
- **Move** - move selected points, can also phase-shift the curve of linear effects in steps of 30 degree (only if no partial selection was made)
- **Scale** - scale linear effects on y-axis or focus effects separately on x- and y-axis
- **Gamma** - apply a log function to the curve (linear effects only)
- **Size** - scale focus effects on both axis
- **Rotate** - rotate focus effects around the center of the selected points

The following actions are available when editing the curve:

- **Select All** - selects all points
- **Smooth** - smooths the selected points
- **Mirror Hor. / Vert.** - mirrors the curve
- **Subdivide** - adds one point on each selected segment (useful to move that point or change the behavior of smooth)
- **Remove** - removes the selected points
- **Undo** - undoes the last operation
- **Redo** - redoes the last operation

## Programming a New Relative Effect

Below is the process used to program a new relative effect.

### Example:

To open the effects list press:

- [Effect] [Effect]

Establish the number of the effect by pressing:

- [Effect] [4] {Type} {Linear/Focus/Color} [Enter]

The effect will appear in the effect list and the CIA will repaint with the effect details visible. Manipulate the effect using the encoders, effect graph, and/or property fields so that the effect meets your needs (see [Effects Editor \(on page 325\)](#) for details on effect properties and encoders).

## Preprogrammed Rainbow Effects

Two preprogrammed rainbow linear effects are available in the effect list. Effect 917 is a Rainbow RGB effect, and effect 918 is a Rainbow CMY effect. These effects are for a rainbow on native color parameters that will fade hue from 0 to 360 with saturation at full, when the

parameters are at their default levels. 0 is the default for CMY, and Full is the default for RGB.

## Apply an Existing Effect

Once an effect has been created, it will appear in the effects list. To apply an existing effect, press:

- [Select Channels] [Effect] [x] [Enter]

or using the direct selects

- [Select Channels] {Effect x}

The selected channels will begin their changes as programmed in the effect.



**Note:** *Since step based effects have an embedded channel list, those effects can be recalled by [Group] [Effect] [n] [Enter] or [Recall From] [Effect] [n] [Enter] without selecting channels.*

---

## Editing Effects Live

To edit an effect while it is running, press:

- [Displays] {Effect Status}

The effect status display will open in the CIA and any currently running effects will be visible in the display. Selecting the effect number in the status display will select the effect for editing. Select the effect you want to edit live by pressing:

- [Effect] [x] [Enter]

Adjust the attributes as described in [Effect Status Display \(on page 329\)](#). Adjustments are cue overrides and don't impact the core effect. Changes made to effects in the effect status display impact only that instance of the effect. The changes will then need to be recorded or updated.

To edit other properties of the effect in live, press **{Edit}** and the effects editor will open (See [Effects Editor \(on page 325\)](#)). Changes made in the editor will impact the effect itself and all instances in which the effect is used.

## Stop an Effect

Pressing **[Stop Effect] [Enter]** will stop all running effects.

To stop a specific effect, press: **[Stop Effect] [x] [Enter]** or **[Effect] [x] [At] [Enter]**.

You may also stop effects on specific channels by **[selecting channels] [Effect] [Enter]**.

You may also remove an effect instruction by **[selecting channels] [Effect] [At] [Enter]**. This command will work in live or blind. You can also stop the whole effect by pressing **[Effect] [x] [At] [Enter]**.

On Element 2, you will need to press **[Live] {Fader Control}** to see **{Stop Effect}**.

## Assigning a Stop Effect Command

A **[Stop Effect]** command can be assigned to a list of channels in a cue without an effect tracking into it, or to a list of channels in a submaster. See [Freeze and StopEffect on Submasters \(on page 362\)](#) for more information. On Element 2, you will need to press **[Live] {Fader Control}** to see **{Stop Effect}**.

- **<channel> [1] [Stop Effect] [Enter]** - will create a stop effect instruction for all selected parameters, if there isn't an effect running on any of the parameters.
- **<channel> [1] [Effect] [Enter]** - will only stop the currently running effect.

## Query and Group Effect

You can use **[Query] [Effect] [n]**, **[Query] [Effect]**, and **[Group] [Effect] [n]** to select the channels currently running in the selected effect.

Using **[Query]** will select the channels in numeric order. **[Group]** will select the channels in the order that they were originally selected.

**[Query] [Effect]** will select all channels currently running effects.

On Element 2, **{Query}** is a softkey.

### Example:

- **[3][1] [+] [2][6] [+] [3][0] [+] [2][7] [+] [2][9] [+] [2][8] [Effect] [1] [Enter]**

Using **[Query] [Effect] [1]** will select the channels currently running effect 1. Using **[Next]**, the channels will be selected in numeric order starting with channel 26.

Using **[Group] [Effect] [1]** will select the channels currently running effect 1. However, pressing **[Next]**, the channels will be selected in the order they were originally selected. In this example, channel 31 would be first, then channel 26.

## Using Offset

You can use the **{Offset}** softkey to aid in channel selection of an effect. For an explanation of the offset options, see [Offset \(on page 205\)](#).

- **[Select Channels] {Offset} {Random} [Effect] [1] [Enter]**

## Replace With

**{Replace With}** allows you to replace an effect with another one. All overrides will be preserved.

- **[Effect] [1] {Replace With} <Effect> [2]** - all channels that were running effect 1 will now be running effect 2.

## Deleting an Effect

To delete an effect, press **[Delete] [Effect] [n] [Enter] [Enter]**. If you delete one of the default effects (901 through 918), that effect will return to its default values.

## Recording an Effect to a Preset

Effects can be stored in a preset, and those presets can be used to create submasters and cues. However, the effect's data is only copied to the submaster or cue, it is no longer referenced through the preset.

For more information, see [Effects In Presets \(on page 238\)](#).

To apply an existing effect, press:

- **[Select Channels] [Effect] [x] [Enter]**

Recording to a preset, press:

- **[Record] [Preset] [x] {Plus FX} [Enter]**

Pressing **[Effect]** after **[Record] [Preset] [x]** will append **{Plus FX}** to the command line.

- **[Record] [Preset] [x] [Effects] [Enter]**

## Recording an Effect in a Cue

To apply an existing effect, press:

- [Select Channels] [Effect] [x] [Enter]

Recording to a cue, press:

- [Record] [Cue] [x] [Enter]

Recording to a cue part, press:

- [Record] [Cue] [x] [Part] [x] [Enter]

## Effects on Faders

Channels running effects can be loaded onto a submaster. By default pressing the bump button of the submaster starts or stops the effect.

For the submaster to control the rate and/ or size of the effect, it can be configured as an effects submaster. To configure an effects submaster, see [Submaster Properties \(on page 355\)](#).



**CAUTION:** When a submaster is defined as effect, only the effect information is stored.

---

There are several submaster button and fader configuration options that affect how effects run. See [Submaster Fader and Button Configuration \(on page 359\)](#) for more information about those options.

## Configuring an Effect Submaster

To configure an effect submaster, press:

- [Sub] [x] {Properties} [Enter]



**Note:** The {Properties} softkey will open the submaster properties display in the CIA. For more information, see [Submaster Properties \(on page 355\)](#).

---

## Recording an Effect to a Submaster

To apply an existing effect, press:

- [Select Channels] [Effect] [x] [Enter]

Recording to a submaster, press:

- [Record] [Sub] [x] [Enter]

A submaster can be configured to be an effect submaster. You can configure at the same time as you record the submaster. Before you hit [Enter], hit the softkey for {Properties} to open the submaster properties display in the CIA. Select **Effect** as the mode. For more information, see [Submaster Properties \(on page 355\)](#).

## Running an Effect from a Submaster

The way effects are played back from a submaster depends on its mode, and whether the submaster is set to be a proportional fader or an intensity master.

Below is an example of four different submasters, in different modes, with the same effect stored to them.

## ***Effect on an Additive/ Proportional Submaster***

The submaster contains the intensity, pan/tilt data, along with the effect. Pressing the bump button starts the effect. The fader controls values not affected by the effect. Pressing the bump button again stops the effect.

## ***Effect on an Additive/ Intensity Master Submaster***

Pressing the bump button marks the lights, and starts the effect. The fader brings up any intensities stored in the submaster. Pressing the bump button again stops the effect.

## ***Effect on an Effect/ Proportional Submaster***

Pressing the bump button starts the effect. The fader controls the rate and/ or size based on the effect's entry behavior. Pressing the bump button again stops the effect.

## ***Effect on an Effect/ Intensity Master Submaster***

Pressing the bump button starts the effect. The fader controls the rate and/ or size based on the effect's entry behavior. Pressing the bump button again stops the effect.

In other words, there is no difference between a proportional fader and an intensity master when the submaster is configured to be an effect submaster.

## **Global Effects Fader**

A fader can be mapped as global effects in the [fader configuration display](#), [Tab] [3][6]. This fader type is used to master all effects or specific effects based off of the current filtering applied to the fader.



**Note:** *You can use multiple global effects faders.*

---

The following filters can be applied to effects running on:

- **Cue lists** - you can specify certain cue lists or select **{All}** or **{None}**. Not available on Element 2.
- **Submasters** - you can specify certain submasters or select **{All}** or **{None}**.
- **Channels** - you can specify certain channels that will be affected by the global effects fader. See [Channel and Parameter Filters on Faders \(on page 84\)](#)
- **Parameters** - you can specify certain parameters that will be affected by the global effects fader. See [Channel and Parameter Filters on Faders \(on page 84\)](#)
- **Effects** - you can specify certain effects or select **{All}** or **{None}**.
- **Manual** - when on, the global effects fader will only affect manually run effects. By default, this is off.



**Note:** *If no filters have been applied, the fader will master all effects.*

---

## ***Fader Options***

The following fader options are available for a global effects fader:

- **Effect Rate** - fader centers to home. It controls the rate of any running effects (same behavior as using rate via the Effect Status Display). Min is 0, and Max is 200.
- **Effect Size** - similar to Effect Rate but for effect size. Min is 0, and Max is 200.
- **Fader Disabled** - no action is assigned to the fader.
- **Effect Master** - masters the entry/ exit mode of the effects (size, rate or both).

## Button Options

The following options are available for global effect buttons:

- **Bump** - plays back the effect at 100% of the recorded level. It will continue to do so until released.
- **Freeze** - halts all effect activity on the fader.
- **Start Stop Effect** - starts the effect while ignoring dwell times. Will stop effects if any are running.
- **Button Disabled** - no action is assigned to the button.
- **Macro** - allows you to assign a macro as a button action.

## Delaying Effects

A delay can be placed on an effect in a cue or submaster by using the syntax **[Effect] [n] [Delay] [n] [Enter]**. **[Effect] [n] [Delay] [Enter]** removes the delay.



**Note:** If an effect delay is set in live, the cue or submaster must be recorded to include the delay.

The Effect Status display has a delay column to show when a delay has been applied to an effect. When an effect is in delay mode, the column will display the countdown for the delay.

Effect	Source	Channels	Delay	Rate	BPM	Size	HForm	VForm	Axis
1*	Cue 7	26>31 36>41 46>51	10	100		100			
2	Sub 8	6>20		100		100			
5	Man	71>78		100		100			
Effect	Attributes		Duration	Entry		Exit		Grouping	Trail
1			Infinite	Time 0 Fade by Size Cascade		Time 0 Fade by Size		Spread	Solo

When an effect is delayed, a “\*” will display by the effect number in the playback status display FX column.





# Chapter 19

## Using Park

---

About Park .....	350
Park Display .....	350
Parked Values in Live .....	350
Parked Addresses in Live .....	351
Park Values from the Park Display .....	351

## About Park

The park instruction allows you to set a channel or parameter to a specific value and have it remain at that level on stage (live mode), prohibiting manual control override, cue or submaster playback modification. Park may also be used to place a scaling instruction on the intensity output of a channel.



**Note:** *A parked channel intensity is not impacted by grandmaster or blackout operations.*

---

Parked values are withheld from all record targets, but you can manually set levels for parked channels and parameters and store those values into record targets. Keep in mind that the values set and stored in live do not actually output to the system if the parameter is parked.

When channels or parameters are parked, the LED on the **[Park]** button illuminates and the live display will indicate “Parked Channels” or “Parked Dimmers” in the top right corner. In addition, any parked channel or parameter will be indicated with a white channel number and a “P” will be visible in the channel. When the parked channel or parameter is unparked, it reverts to the level the console is currently providing, or its default value if there is no current instruction.

Park instructions are not subject to partition control. Any programmer/ operator may park and unpark channels/ parameters as needed. Parked parameters set by radio focus remotes (RFR) will automatically unpark when the associated device goes offline.

Channels, parameters and outputs can be parked and unparked from live and from the park display.

## Park Display

You can access the park display by pressing **[Park] [Park]** or **[Tab] [2][0]**. The park display shows all parked channels and parameter values on the top half of the screen and all parked addresses (dimmers) on the bottom half of the screen. Parked channels displayed on the top of the screen can be displayed in the summary and table views seen in live /blind by using the **[Format]** key.

When a channel intensity is parked, the parked value will be indicated in white text. When a channel has a non-intensity parameter that is parked, that parameter will also be indicated with white text. The display also provides detail of which user parked the channel and /or parameter (when multiple users are on the system).

When an address is parked, it will appear in the bottom half of the park display. The address, parked value, affected channels and parameters are indicated.

## Parked Values in Live

Channels and parameters may be parked and unparked from the live display. Following are some examples:



**Note:** *To park a channel to a specific dimmer intensity level must be accomplished from the Parked Channel display. Access the Parked Channel display by pressing **[Tab] [2][0]** or **{Park}{Park}{Park}** twice.*

---



**Note:** *Parked values will be displayed in the park display and in **[About]** & **[Park]**.*

---

To park a channel, parameter, or group from live:

- [2] [At] [5] [0] [Park] [Enter] - parks channel 2 intensity at 50%
- [2] {Intensity} [Park] [Enter] - parks the intensity of channel 2 at its current value
- [2] [Park] [Enter] - parks all parameters of channel 2 at their current settings



**Note:** *If a channel list is constructed in which some channels are parked and some are unparked, [Park] [Enter] will unpark them all. A confirmation will be required.*

- [2] [At] [Park] [Enter] - if channel 2 is unparked, this command parks intensity at the current value. If the intensity for channel 2 is parked, this command unparks intensity.
- [2] [Color Palette] [8] [Park] [Enter] - parks the color for channel 2 in color palette 8.
- [Group] [Cue] [6] [Park] [Enter] - parks all the channels stored in cue 6 at their current levels.
- [Park] [Enter] - clears all parked channels and scaled park instructions (see [Scaled Parked Values in Live](#)). A confirm is required. When a channel is unparked, it reverts to the level the console is currently providing, or its default value if there is no current instruction. A confirmation will be required.

You can use [Recall From] [Park] to set a channel or parameter to the same level as the current park value. See [Recall From Park \(on page 296\)](#) for more information.

## Scaled Parked Values in Live

A scaled parked value allows the intensity output (only) to be modified proportionally in live. Scaled park values are ignored when storing a record target. The setting on the display indicates what should be stored, not the actual scaled value. An example of how to set a scaled parked value in live includes:

- [3] [At] [/] [1] [2] [5] [Park] [Enter] - sets a scaled value of 125% on channel 3 intensity. In other words, whenever channel 3 is active, it will be active 25% higher than its current setting.
- [3] [At] [/] [8] [5] [Park] [Enter] - sets a scaled value for channel 3. Whenever channel 3 is active, it will playback 15% lower than its current setting.

Remove the scaled parked value:

- [3] [Park] [Enter] - unparks a scaled intensity for channel 3.
- [Park] [Enter] - unparks all parked channels.

A channel can have both a scaled parked value and a parked intensity value. Keep in mind that the parked intensity has priority over (and overrides) scaled park values.

## Parked Addresses in Live

DMX addresses can be parked in Live. Below are some examples of parking an address in Live:

- [Address/Patch] [5] [At] [5] [0] [Park] [Enter] - parks output 5 at 50% intensity.
- [Address/Patch] [5] [Park] [Enter] - unparks output 5.
- [Address/Patch] [Park] [Enter] - unparks all parked outputs.

## Park Values from the Park Display

You can park and unpark channel parameters or addresses from the park display. Open the display by pressing [Park] [Park] or [Tab] [2] [0]. While in this display, it is assumed that you want to park channels or parameters, therefore the use of the [Park] key is not necessary when parking, but is used for unparking. You can also use [At] [Enter] to unpark.



Following are examples for parking channel parameters from the park display:

- [3] [At] [4] [5] [Enter] - parks channel 3 at 45%.
- [3] [Color Palette] [4] [Enter] - parks color for channel 3 at color palette 4.

You can use the {Offset} softkey to aid in channel selection. For a list of the {Offset} options, see [Offset \(on page 205\)](#).

Following are examples for clearing parked values while in the park display:

- [Select Active] [Park] [Enter] - clears all parked channel parameter values.
- [channel list] [Park] [Enter] - un parks channels in the list.
- [channel list] [At] [Enter] - un parks channels in the list.

Below are examples for parking addresses in the park display:

- [Address/Patch] [5] [At] [5] [0] [Enter] - parks address 5 at 50% intensity.
- [Address/Patch] [5] [At] [Enter] - un parks address 5.



**Note:** When parking a range of addresses in Park, using [Thru] will only park the intensities. If you want to park all of the addresses and parameters within the selected range, you will need to use [Thru] [Thru].

# Chapter 20

## Storing and Using Submasters

---

About Submasters .....	354
Paging Submasters .....	354
Recording a Submaster .....	354
Submaster List .....	355
Submaster Properties .....	355
Submaster Information .....	360
Labeling a Submaster .....	361
Loading Submasters .....	361
Using Bump Button Timing With Submasters .....	361
Execute List .....	362
Freeze and StopEffect on Submasters .....	362
Moving and Copying Submasters .....	363
Releasing Content From a Submaster .....	363
Updating a Submaster .....	364
Deleting a Submaster .....	364

## About Submasters

Submasters can store any parameter data for channels. When storing from Live, Record Only and Record can both be used to determine what contents are stored. You can copy cues, presets, or palettes to a submaster as well. Channels running effects can be loaded onto a submaster. See [Effects on Faders \(on page 345\)](#)

Submasters can be controlled by faders or by the keypad. Faders can be configured as submasters (see [Submaster Properties \(on the facing page\)](#)) or they can be defined while programming.



**Note:** You can record up to 1000 submasters.

In Blind, submasters can be created by using the **[Thru] [Thru]** syntax.

- **[Sub] [1] [Thru] [Thru] [1] [0] [Enter]** - will create subs 1 through 10.

When set as a submaster, the bottom buttons beneath the fader can be configured for different functions. See [Submaster Fader and Button Configuration \(on page 359\)](#) for more information.

It is possible to program upfade, dwell, and downfade times in association with the submaster bumps. See [Submaster Properties \(on the facing page\)](#) for more information.

## What does a Blinking LED Mean?

When a submaster bump LED is blinking, it means that the submaster must be homed due to either changes to its content or to its mode. In either case, reset the submaster by dropping it to zero and the moving it back to the desired position. The LED will also blink when the submaster is in a "Hold" state via bump button timing.

## Paging Submasters

Element 2 has a total of 1000 submasters. The fader position switch can be placed in faders 1-40 or 41-80 modes. Element 2 will default to the first 80 faders. To page through the available submasters, hold down the **{Page Subs}** softkey in the Live display. The bump buttons will light up in green, and the bump buttons that correspond to the currently selected pages will flash. Press the corresponding bump button to go to that page. The fader ribbon will change to show the submaster pages.

Page 1 1-40	Page 2 41-80	Page 3 81-120	Page 4 121-160	Page 5 161-200	Page 6 201-240	Page 7 241-280	Page 8 281-320	Page 9 321-360	Page 10 361-400	Page 11 401-440	Page 12 441-480	Page 13 481-520	Page 14 521-560	Page 15 561-600	Page 16 601-640	Page 17 641-680	Page 18 681-720	Page 19 721-760	Page 20 761-800
Page 1 1-40	Page 2 41-80	Page 3 81-120	Page 4 121-160	Page 5 161-200	Page 6 201-240	Page 7 241-280	Page 8 281-320	Page 9 321-360	Page 10 361-400	Page 11 401-440	Page 12 441-480	Page 13 481-520	Page 14 521-560	Page 15 561-600	Page 16 601-640	Page 17 641-680	Page 18 681-720	Page 19 721-760	Page 20 761-800

## Recording a Submaster

You can record current stage contents directly to a submaster. To do this, set levels in live as needed then record them to the submaster. See the following examples:

- **[Record] [Sub] [5] [Enter]** - records all current values to submaster 5.
- **[Record Only] [Sub] [5] [Enter]** - records the manual values of the current stage state to submaster 5.
- **[Record Only] [Sub] [5] [Label] [xxxx] [Enter]** - as above, with a label.
- **[Record] [Sub] [5] {Properties}** - opens the [submaster properties](#) window so you can select properties while recording your submaster.
- **[Record] [Load]** - records all current values to the fader associated with the load button. Submaster will be stored with the number associated with the chosen fader.

- **[Record] [Both Bump Buttons]** - records all current values to the fader associated with the bump buttons. Submaster will be stored with the number associated with the chosen fader.

You can also record selected channel data to submasters as well.

- **[Channel List] [Record] [Sub] [5] [Enter]** - records all data for the channel list to submaster 5.
- **[Channel List] [Record Only] [Sub] [5] [Enter]** - records manual data for the channel list to submaster 5.

Submasters can also be recorded using selective storing, which allows you to specify only the channels that you want stored.

- **[6] [Thru] [1][0] [Record] [Sub] [3] [Enter]** - records only channels 6 through 10 to submaster 3.
- **[1] [Thru] [5] {Blue} [Record] [Sub] [6] [Enter]** - records only the blue color for channels 1 through 5.
- **[1] [Thru] [1][0] {Offset} {Odd} [Record] [Sub] [4] [Enter]** - records channels 1, 3, 5, 7, 9 into submaster 4. For more information on using Offset, please see [Offset \(on page 172\)](#)

If a submaster already has data stored to it, selective store will act as a merge function. Using the above example of channels 6 through 10 stored to submaster 3, if you were to then store channel 5 to submaster 3, that would be added to the current content so that channels 5 through 10 are now stored.

If you don't want the data to merge, you can either first delete the submaster to remove the original content (see [Deleting a Submaster \(on page 364\)](#) or you can selective store while using **[Rem Dim]**.

- **[5] Record] [Sub] [3] [Rem Dim] [Enter]** - records channel 5 to submaster 3 and removes any previous data from the submaster.

## Submaster List

You can access the submaster list by pressing **[Sub] [Sub], [Tab] [1][5]** or through the browser (**Record Target Lists>Submaster List>[Select]**). Either of these commands will open a new tab for the submaster list or if it is already open on a tab, will bring focus to the list.

The list view includes a list of all submasters including their labels and all properties. You can navigate within the list by using the **[Next]** and **[Last]** buttons or by selecting the desired submaster from the command line.

## Editing Submasters

While in the Submaster list, if you want to edit the contents of the submaster, you can select the submaster and press **{Edit}**. This changes focus to the Live/ Blind tab and places you into the Blind edit mode for the specified submaster. You may also press **[Blind]** and select the required submaster from the command line.

Any changes made in this screen are automatically stored. A **[Record]** or **[Update]** command is not required.

## Submaster Properties

Faders can be mapped to a submaster in the fader configuration display, or by recording or loading a submaster. See [Fader Configuration \(on page 78\)](#), [Recording a Submaster \(on the previous page\)](#), or [Loading Submasters \(on page 361\)](#) for more information.

If a fader has been configured for default mapping in the fader configuration display, the fader will receive its configuration from the [Submaster List](#). Changes made to a submaster in the submaster list will be shared with any default mapping faders loaded with that submaster. If changes are made to a fader set to default mapping in the fader configuration display, those changes will also happen in the Submaster List. If set to Local, any changes made in the fader configuration display will impact only that instance of the content.

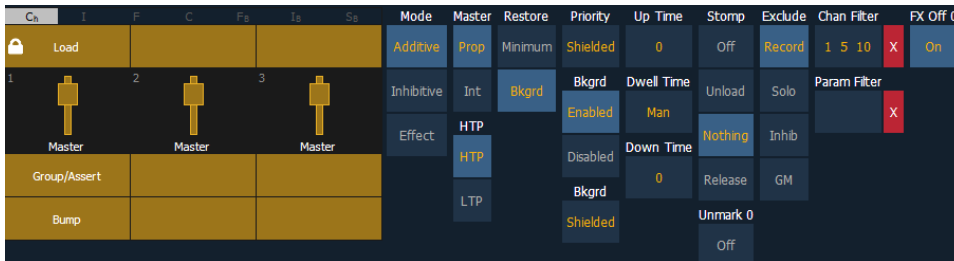

The following options are available when a fader is configured as a submaster:

## Mode

You may define your submaster as additive (contributes to the live output), inhibitive (limits live output) or an effect submaster. Eos defaults to submasters being additive.

Additive submasters are indicated by a green LED and a yellow fader icon in the fader ribbon.

Inhibitive submasters display these indicators in red. Channels mastered by an inhibitive submaster are indicated with an "I" next to the intensity value in the channel display in live. Inhibitive submasters do not provide levels to the stage picture, they limit them (similar to a grandmaster). It is possible to put non-intensity parameters onto an inhibitive submaster, but it must be done from blind.

For more information about effect submasters, see [Effects on Faders \(on page 345\)](#).

## Master

A fader can be assigned as a Master. When it is a master, its behavior as a Proportional Master or Intensity Master (I-Master) is drawn from this setting.

### ***Proportional Master***

When a submaster is proportional, the slider will control all contents of the submaster (intensity and non-intensity parameters) when moved from zero. When a proportional sub is returned toward zero, channel will be returned to their previous level.

The bump button can be used to bump all values to their recorded levels in the submaster, or, by assigning timing values, fade the contents of the submaster up or out. Eos defaults to submasters as proportional.

### ***Intensity master***

When set to intensity master, the slider will control intensity only. The bump button can be used to preset (mark) non-intensity parameters stored to the submaster. If the bump is not pressed before the slider is moved, the slider will also fade the non-intensity-parameters to their recorded values. Once the non-intensity-parameters are at their end state, the slider only controls intensity. When dropped toward zero, controlled intensities will be faded toward zero.

When non-intensity parameters on a intensity master submaster have been marked using the bump button, the LED on its bump button will blink to tell you that the non-intensity parameters have been marked.



Pressing the bump button for an intensity master submaster that is currently bumped will release the non-intensity parameters using the bump button timing. Its bump button LED will also be turned off.



**Note:** For channels that have been set to GM Exempt in Patch, Intensity Master control will not impact the intensity of those channels. See [{Attribute} Display and Settings \(on page 124\)](#) for more information.

---

## HTP

Intensity playback behavior can be set to HTP (highest takes precedence) or LTP (latest takes precedence). Non-intensity parameters are always LTP. Eos defaults all submasters to HTP. For more information on HTP and LTP see [HTP vs. LTP \(on page 9\)](#).

## Restore

Submasters can be placed into restore modes of minimum or background, which is the default. When a submaster is in the restore to background mode, the restore column of the submaster list display will be blank. When in minimum mode, 'Min' will display in the restore column.

The restore mode of background means that when the submaster is returned to zero, control will be restored to the background value, such as another submaster or a cue.

The restore mode of minimum means that when the submaster is faded down, control does not go to the previous background state but to the parameters' minimum value.

## Priority



**Note:** Priority was previously called Independent.

---

There are 10 levels of priority for submasters. 1 is the lowest and 10 is the highest. The default priority level is 4.

## Shielded

Submasters can be shielded, which means that their content is automatically made exclusive and can't be controlled by anything other than that submaster and park, including by manual control. Shielded has a higher priority than 10.

Channels stored to shielded submasters will display in yellow with a superscript 's' beside it.

If channel parameters stored to shielded submasters were previously stored to cues or other submasters, those instructions will be ignored on playback.

If the same channels are assigned to more than one shielded submaster, control of those channels will be shared on either a LTP or HTP basis depending on the settings for the submasters.

## Background

Submasters can have their background states disabled. Background states are enabled by default. When enabled, the content of the submaster will act as a background or previous state for other cues and submasters.

When a submaster has its background state disabled, a "D" will be displayed in the Submaster List background column.

### Example:

Cue 1 has channel 10 at 25%. Submaster 1 is raised and has channel 10 at 50%. Submaster 2 is then brought up and has channel 10 at Full. When submaster 2 is lowered to zero, control will be returned to submaster 1. If submaster 1 is lowered to zero, control will return to cue 1.

Using the above example, if submaster 1 has its background state disabled, which makes its content unavailable as a background state, then when submaster 2 is lowered to zero, control would return to cue 1 and not to submaster 1.

## Background Priority

Background can have a priority assigned to it. Background priority releases to the highest priority content that previously had ownership, provided that content has not been turned off or released.

There are 10 levels of background priority for submasters. 1 is the lowest and 10 is the highest.

## Up Time

This is the time for the submaster to fade from its home position to its target position (0 to Full if additive, Full to 0 if inhibitive). The default time is 0.

## Dwell Time

This is the time the submaster look will hold before starting the downfade. This can be set to a specified time, or to "Hold" or "Manual". "Hold" time maintains the submaster values until the bump is pressed a second time. "Manual" time applies the submaster values only as long as the bump is held. The default is "Manual".

## Down Time

This is the time for the submaster to fade from its target position to its home position. The default time is 0.

## Stomp Mode

Stomp happens when all the content owned by a submaster is now being controlled by other targets. The submaster is being removed from the background, and once that happens, it would not be eligible to fade back. You can assign behavior that will happen when a submaster is stomped.

The following are Stomp Mode options:

- **Off When Stomped** - puts the content into an off state, the same behavior encountered when pressing [Off] & [Load].
- **Unload When Stomped** - unloads the fader.
- **Nothing When Stomped** - no action happens to the submaster.
- **Release When Stomped** - This function behaves the same as Off When Stomped.

## Unmark at 0%

When this option is on, marked content controlled by the submaster will automatically be released when the fader reaches 0%. When the bump button is next pressed, the submaster will fire. If this option is off, you would need to first press the bump button to reset the submaster before pressing the bump again to fire it.



**Note:** This option is for submasters that are set to Intensity Master.

## Exclude

Those exclusions include:

- **Exclude From Record** - output is not recorded into any other record target.
- **Exclude From Grandmaster** - content cannot be mastered by a grandmaster.
- **Exclude From Inhibitive Sub** - content cannot be mastered by an inhibitive submaster
- **Exclude From Solo** - content will ignore solo. See [Submaster Fader and Button Configuration \(below\)](#) for more information on solo.

## Channel and Parameter Filters

Channel and Parameter Filters can be used to allow only specified data to be played back. These are playback filters, and do not impact how data is recorded.

For submasters, channel and parameter filters can be set in the following areas:

- Submaster List
- In Live using the **{Properties}** softkey

Tap or click on **{Chan Filter}** to assign channels or groups. Tap or click on **{Param Filter}** to open a list of available parameters that you can filter.



**Note:** *Filters will travel with their assigned submasters wherever they are mapped.*

---

When a filter has been applied, an indicator will display in the fader ribbon. C will display for channel filter, and F is for parameter filter.

Press the red **[X]** to clear the channel or parameter filters listed.

## FX Off 0

Starts the effect when master fader is moved from 0, stops the effect when it is moved to 0. This is enabled by default.

## Submaster Fader and Button Configuration

Click or tap on the virtual buttons or fader to see a list of available configuration options.

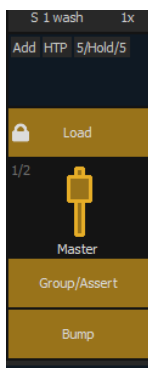

## Button Options

The following options are available for submaster buttons:

- **Bump** - plays back the submaster at 100% of the recorded level. It will continue to do so until released, unless the submaster has a time assigned or the **{Hold}** property set.

- **Group/ Assert** - selects all the channels associated with the submaster, if the submaster is inactive. If the submaster is active, the contents of the submaster will be asserted.
- **Assert** - regains control of all of the channels associated with the submaster.
- **Group Select** - selects the channels stored in the submaster. This is the same as **[Group] [Sub] [n]**.
- **Freeze** - halts all effect activity on the fader.
- **Off** - removes the content and if the fader is set to Master, the fader will remain where it currently is.
- **Release** - removes the content and if the fader is set to Master, the fader will reset to 0.
- **Start Stop Effect** - starts the effect while ignoring dwell times. Will stop effects if any are running.
- **Button Disabled** - no action is assigned to the button.
- **Mark NPs** - If no non-intensity parameters are owned by the submaster, it will fade the parameters on any dark channels in bump up time. If any non-intensity parameters are owned by the submaster, it releases the non-intensity parameters in bump down time. Dwell time and mode are ignored.
- **Solo** - suppresses any intensity values not provided by the associated content while the solo button is held down. When the button is released, intensity values are restored. Priority and HTP are ignored. Shielded, park and pixel mapping outputs are not affected by the solo button.
- **Back** - fades to the previous cue when fader is assigned to a cue list.
- **Macro** - allows you to assign a macro as a button action.

## Fader Options

The following options are available for a submaster fader:

- **Master** - fader will be a proportional master, a manual master, or an intensity master.
- **Effect Rate** - fader centers to home. It controls the rate of any running effects (same behavior as using rate via the Effect Status Display). The adjusted setting from this control cannot be stored.
- **Effect Size** - similar to Effect Rate but for effect size.
- **Rate Master** - homes to center. It adjusts the cue rate, just like rate and load.
- **Fader Disabled** - no action is assigned to the fader.
- **Master Only** - fader is used to set a level for content to fade to. The slider can be used to live adjust levels when the fader has been activated via the bump button. See [Master Only \(on page 84\)](#) for more information.
- **Effect Master** - masters the entry/exit mode of the effects (size, rate or both).
- **Levels Only** - masters the levels without mastering the effect.

## Submaster Information

In the window above any programmed submaster, you will see the following:

On Element 2, you will see this information in the fader status display. See [Indicators in the Element Fader Status Display \(on page 80\)](#)



**Note:** *Inhibitive submasters display in red and additive submasters in yellow.*

- 
- Submaster number
  - Submaster label (if any)
  - Priority flag (if any)
  - I-Master flag (if any)
  - Current submaster value

## Labeling a Submaster

Submasters can be labeled using the [Label] key.

- [Sub] [6] [Label] [xxxx] [Enter] - labels submaster 6.
- [Sub] [6] [Label] [Label] [Enter] - removes the label.



**Note:** If you would like your label to word wrap, use // to create a line break between words.

---

## Loading Submasters

Submasters can also be loaded with cues, presets, or palettes. You can convert an empty fader to a submaster without configuring it in fader configuration display. Any fader can be configured and loaded with a submaster if:

- the fader is not configured

-or-

- the fader is configured as a playback but has no cue list loaded to it

-or-

- the fader is configured as a submaster, but that submaster is empty.

Regardless of the fader configuration, if the above conditions are met, the fader can be loaded with the submaster or target specified on the command line.

If data already occupies the fader, that fader must be unloaded before another target can be loaded. See [Releasing Content From a Submaster \(on page 363\)](#)

- [Sub] [5] [Load] - loads submaster 5 to the fader associated with the load button.
- [Int Palette] [1] [Load] - loads intensity palette 1 to the submaster associated with the chosen load button.
- [Cue] [5] [Sub] [4] [Enter] - loads the contents of cue 5 to submaster 4 (a {CopyTo} command will appear within the syntax on the command line).
- [Cue] [5] [Load] - loads cue 5 to the submaster associated with the chosen load button.
- [-] [5] [Cue] [5] [Sub] [6] [Enter] - loads the contents of cue 5, minus channel 5, to submaster 6.
- [Cue] [1] [Thru] [5] [Sub] [1] [Thru] [4] [+] [7] - sequentially loads cues 1 through 5 to subs 1, 2, 3, 4 and 7.
- [Cue] [1] [Thru] [5] [Sub] [1] [Thru] [Enter] - sequentially loads cues 1 through 5 to subs 1 through 5 (a {CopyTo} command will appear within the syntax on the command line).

## Using Bump Button Timing With Submasters

Each submaster bump can have three different timing values: Up fade, Dwell, and Down fade (see [Submaster Properties \(on page 355\)](#)). The default timing is set so that the bump functions as an “on” flash key for additive submasters and an “off” flash key for inhibitive submasters. Effects on submasters will follow submaster timing, unless timing has been placed in the effect itself.



**Note:** At any time, the fader can be used to manually override fade progression or a submaster triggered with time.

---

To add bump button timing live:

- **[Sub] [8] [Time] [3] [Time] [4] [Time] [3] [Enter]** - adds a 3 second up fade, 4 second dwell and 3 second down fade to submaster 8.
- **[Sub] [2] [Time] [Time] {Manual} [Time] [3] [Enter]** - adds a manual dwell time and a 3 second down fade time to submaster 2. When the bump is pressed and held, it will flash on and stay on until the button is released. It will then begin the down fade.
- **[Sub] [4] [Time] [3] [Time] {Hold} [Enter]** - adds a 3 second up fade time, and a hold dwell time. When the bump is pressed, the up fade starts. Once at the target value it will remain there until the button is pressed again. The down fade will bump to zero.
- **[Sub] [3] [Time] [Enter]** - resets all time for submaster 3 to default (Up = 0, Dwell = Manual, Down = 0).

## Controlling Subfades Manually

It is possible to take control of submasters even if they have recorded time. To capture the fade, you must push the fader past the current fade level. Once this is done, control is transferred to the fader for full manual control.

You may then use the fader to increase or decrease the submaster level as needed.

## Execute List

The execute list for submasters can be used to trigger actions such as macros, snapshots, MIDI Raw, Serial Strings, and cues. This works similar to the External Links for cues.

There is an **{Execute}** softkey that is available after you press the **[Sub]** button in either Live, Blind, or the sub list display.

When you press **{Execute}**, the softkeys will change to **{String}**, **{Macro}**, **{Relay}**, **{On}**, **{Off}**, **{Snapshot}**, and **{MIDI Raw}**.



**Note:** *Macros can also be assigned as a button action. See [Submaster Fader and Button Configuration \(on page 359\)](#)*

---

## Triggering an Action

Pressing the bump button of a submaster will trigger any actions assigned to its execute list.

### Adding a Trigger

- **[Sub] [1] {Execute} {Macro} [2] [Enter]** - triggers macro 2 when submaster 1's bump button is pressed.

### Removing a Trigger

- **[Sub] [1] {Execute} {Macro} [Enter]** - removes the trigger from submaster 1's execute list.

## Freeze and StopEffect on Submasters

### Freeze

**[Freeze]** can be used to halt all effect activity on any active submaster. To activate a freeze for only a specific submaster, press **[Freeze] & [Load]**.

**Note:** *On Element 2, you will need to use the **{Fader Control}** softkey, which displays when **[Live]** is pressed.*

There are two ways to remove the freeze command:

- Press **[Freeze] & [Load]** again for the specific faders to unfreeze the activity.
- Press **[Assert] & [Load]** or **[Go]** or **[Stop/Back]** for the specific faders to resume the activity.

## StopEffect

The **[Stop Effect]** button can be used to stop all effects from operating on any or all faders, or it may be used with the control keypad to stop a specific effect.

**Note:** *On Element 2, you will need to use the {Fader Control} softkey, which displays when [Live] is pressed.*

- To stop all effects on a fader, press **[Stop Effect] & [Load]** of the associated fader.
- To stop a specific effect regardless of the fader it is operating on, press **[Effect] [2] [StopEffect] [Enter]**.

When an effect is stopped, all impact of the effect is removed and the stage output is as though the effect had never been activated.

## Moving and Copying Submasters

You can move a submaster using **Move To**. Press **[Copy To]** twice to put **Move To** on the command line.

### Example:

- **[Sub] [2] Move To [Sub 9] [Enter][Enter]** - moves the contents, label, and timing data from submaster 2 and places it in submaster 9. Submaster 2 is removed.

You can copy the contents of a submaster by using the **[Copy To]** button.

- **[Sub] [2] [Copy To] [Sub 9] [Enter][Enter]** - copies the contents, label, and timing data from submaster 2 and places it in submaster 9.
- **[Sub] [2] [Copy To] [Sub 9] {Attrs Only} [Enter][Enter]** - copies all of the submaster properties from submaster 2 and places it in submaster 9. Levels, effects, and labels are not copied when using the **{Attrs Only}** softkey.
- **[Sub] [2] [Copy To] [Sub 9] {Labels Only} [Enter][Enter]** - copies only the label from submaster 2 and places it in submaster 9.

## Releasing Content From a Submaster

To release content from a submaster, use one of the following methods:



**Note:** *On Element 2, you will need to use the {Fader Control} softkey, which displays when [Live] is pressed.*

---

- **[Off] & [Load]** - stops any running effects and fades out according to the **{Restore}** mode of the submaster.
  - **[Release] & [Load]** - behaves in the same way as **[Off]**. **[Release]** no longer unmaps the fader.
  - **[Shift] & [Load]** - behaves like **[Off]** and **[Release]** except that it will also unmap the fader.
  - **{Fader Control} {Off} & [Load]** - stops any running effects and fades out according to the **{Restore}** mode of the submaster.
  - **{Fader Control} {Release} & [Load]** - behaves in the same way as **{Off}**. **{Release}** no longer unmaps the fader.
  - **[Shift] & [Load]** - behaves like **{Off}** and **{Release}** except that it will also unmap the fader.
- 



**Note:** *When a submaster on a motorized fader is released or turned off, the fader will home.*

---

## Updating a Submaster

It is possible to make changes to a submaster in Live mode. **[Update]** is used to store changes to a submaster.

- **[Update] [Sub] [5] [Enter]** - updates submaster 5 to include changes in live output only for channels already in submaster 5. You can also press the bump button for submaster 5 to select it.
- **[Channel list] [Update] [Sub] [5] [Enter]** - adds only the specified channels to submaster 5.

## Deleting a Submaster

You can delete a submaster using the **[Delete]** key. When a submaster is deleted, the fader remains configured as a submaster, but it will be empty, unless the **{Unmap Faders}** softkey is used.

- **[Delete] [Sub] [5] [Enter] [Enter]** - deletes the contents of submaster 5.
- **[Delete] [Sub] [5] {Unmap Faders} [Enter] [Enter]** - deletes the contents of submaster 5 and unmaps any faders that are currently mapped to submaster 5.



# Chapter 21

## Using About

---

About [About] .....	366
[About] .....	367
{What's New} .....	367
[About] System .....	368
[About] Channel .....	369
[About] Address .....	371
[About] Cuelist .....	373
[About] Cue .....	373
[About] Curves .....	374
[About] Effects .....	374
[About] Groups .....	374
[About] Submaster .....	374
[About] Macro .....	375
[About] IFCB Palettes .....	375
[About] Presets .....	375
[About] Color Path .....	375
[About] Live .....	376

## About [About]

[About] provides detailed information regarding selected elements.

Pressing [About] puts the console in about mode, which allows you to examine about information indefinitely, simply by selecting the element you are interested in. When opened, it appears in the CIA and remains open until closed or until another action forces it to close.

You can also open an About display in a tab by using [Tab] [2][9].

Press the **Link** icon to break the link to the command line for the current About display. When the link is broken, the About display will be forced to keep showing the type of information currently being displayed, such as channel, address, or presets. When linked, the About display will be linked to the command line, and will updated based on which target is selected.

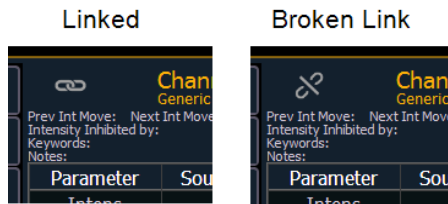

Press {.a[A]} to zoom. There are three zoom sizes: small, medium, & large. Medium is the default size.

When in about mode, selecting a channel will reveal information about that channel. Below are examples of the Current Values view (see below) of information that is presented when selecting conventional or moving lights. For more information about the About Channel display, see [\[About\] Channel \(on page 369\)](#)

Parameter	Source	Value	Abs	DMX	Delay	Time	Marke...	Mark For	Park
Intens	Q 5	IP 4	49	102					
Scroller	Q 5	CP 2	17	132					

Conventional Channel Current Values

Parameter	Source	Value	Abs	DMX	Delay	Time	Marke...	Mark For	Park
Intens	Q 5	IP 5	50	128	10				
Pan	Q 5	FP 1	-97	210 12 (82, 20)	15				
Tilt	Q 5	FP 1	-41	228 49 (89, 65)	15				
Position MSpeed	Q 5	FP 1	0	0	15				
Scroller	Q 5	CP 3	12	219					
Cooling Fan	Q 5	CP 3	100	0					
Scroller MSpeed	Q 5	CP 3	0	0					
Edge	Q 5	0	0	0					
Zoom	Q 5	0	0	0					
Internal Media Fr...	Q 5	0	0	0					
Gobo Ind/Spd	Q 5	0	0	0 (0, 0)					
Gobo Move	Q 5	0	0	0					

Moving Light Channel Current Values

## [About]

When **[About]** is pressed when the command line is clear, the CIA presents the following information:

- System address count
- Software version
- Fixture library version
- Copyright notifications
- Device name
- Assigned as (Primary/Backup/Client/Offline)
- User ID
- Priority (ACN and Net2)
- IP Address(es)
- Number of defined parameters
- Number of patched addresses
- Number of unpatched defined parameters
- Number of pixel mapping addresses
- Number of patched channels
- Number of cues (The number of cues is a count across all cue lists. Multipart cues are only counted once.)
- Allowed output addresses

There are also buttons for [{What's New} \(below\)](#) and [\[About\] System \(on the next page\)](#).

## Parameters and Addresses

The defined parameters field references the number of parameters that have been defined in patch. This includes parameters that have been patched to output addresses and those that have not.

The field below defined parameters, patched addresses, only calculates the number of addresses that have been used in patch (which counts toward available outputs).

The unpatched defined parameters field is useful because even unpatched, but defined, parameters must be displayed and calculated in the fade engine. If you are running a large show, it is helpful to delete defined, but unpatched channels. This is where the **[Query] {Unpatched}** command is helpful.

## Allowed Output Addresses

Allowed Output Addresses is a range or ranges of addresses that can be assigned to limit the number of output addresses. Allowed Output Addresses is a setting in the ECU. Go to **Settings>Network>Output Protocols>Allowed Output Addresses** to make changes if needed.



**Note:** *If you have created ranges for the Allowed Output Addresses, those will display in [About] as well.*

---

## {What's New}

In the **[About]** display, tap on the **{What's New}** button to open the user documentation on the console. The documentation will open in Tab 100.

You can also open the documentation from the Display Management Home Screen by pressing the Manual icon.

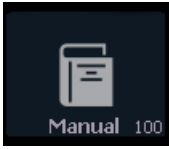

**Note:** Only one instance of the documentation can be open at a time.

---



**Note:** For consoles running Windows XP or Macs running ETCnomad, the manual is not available for viewing. Please see ETC's website, [etconnect.com](http://etconnect.com), to view the online manual or download a PDF version.

---

## [About] System

When **{About System}** is pressed, the CIA displays a list of all network devices that are connected to Eos. These network devices include:

- Consoles
- RPU and RPU3
- Net3 RVI and RVI3
- ETCnomad and ETCnomad Puck
- Net3 Show Control Gateways
- Net3 I/O Gateways
- Legacy Unison CMEi processors
- Unison Paradigm processors
- CEM+, CEM3, FDX 2000/ 3000
- Net3 Gateways
- ETCNet2 Nodes

Each network device will display the following information:

- Device Type
  - Name/Component
  - Status
  - Connected
  - IP Address
- 



**Note:** Devices may appear more than once in this list if they have multiple roles on the network.

---



**Note:** If any errors or warnings are present at the rack, the CEM+ / CEM3 will display in red.

---

Clicking on a CEM+ / CEM3 in the **{About System}** list will open the About Rack display, which shows the following information about the rack:

- Rack Name (displays as the title)
- Type
- Ambient Temperature
- Phase A,B,C Voltages
- Frequency

- System Number
- IP Address
- Software Version
- Rack Errors



**Note:** *Clearing CEM+ / CEM3 errors from Eos will be temporary unless the errors have been fixed at the CEM+ / CEM3. Errors displayed on Eos will clear on their own once they have been cleared from the CEM+ / CEM3. Some CEM+ / CEM3 errors can only be cleared at the CEM+ / CEM3.*

---

Clicking on a FDX rack in the **{About System}** list will open the About Rack display, which shows the following information about the rack:

- Rack number
- Rack Type
- Phase A,B,C Voltages
- Frequency
- System Number
- IP Address
- Software Version

Buttons available in the About Rack screen are **{Activ. Preset}**, **{Deactiv. Preset}**, and **{Clear Errors}**.

## **[About] Channel**

Press **[About]** to put the CIA into About mode. When a channel is selected, the information below is displayed. You can select the information you wish to view from the buttons located on the right side of the CIA. The buttons are:

**{Current Value}** displays information that indicates:

- Channel number
- Device Type
- Most recent intensity move (cue number)
- Next intensity move
- What the channel is inhibited by (if anything)
- Keywords
- Notes
- A list of all parameters on the channel showing the current value and its source, the DMX value, the absolute value, delay and timing information, marking information, and any parked values.

**{Background}** displays similar information:

- Channel number
- Device Type
- Keywords
- Notes
- A list of all parameters on the channel showing the background value and its source, which shows what the parameters will go to if the current control source is removed. The background data will be represented by the standard color coding scheme.

**{Moves}** displays information that shows:

- Parameters
- Previous move in the cue list that currently has ownership

- Value of the previous move (preset, palette, or absolute data)
- Next move
- Value of the next move (preset, palette, or absolute data)

**{Usage}** displays information on how the channel is used, such as:

- Maximum Intensity
- Cue lists it is used in
- Total number of cues it appears in (based on intensity)
- Total number of intensity moves
- List of submasters that include the channel
- List of cues that have move instructions for the channel
- List of cues with dark moves for the channel
- List of cues that the channel is active in
- List of groups that include the channel



**Note:** While in the **{Usage}** screen for About Channel, if another channel is selected, you will need to hit the **{Refresh Usage}** button to see the information for the new channel.

**{Patch}** displays the following information:

- Address range
- Proportional patch level
- Curve (if any)
- GM exempt
- Preheat information (if any)
- Swap/invert pan/tilt status
- Keywords
- Notes
- List of all parameter values with their address, home value, snap parameter, DMX value, and parked value (if any)

The screenshot shows the 'Channel 11 - Part 1' interface. At the top, it displays 'Generic Dimmer' and various settings: Address Range: 385, Proportion: 100, Curve: GM Exempt: No, Preheat: None, Swap: OFF, Invert Pan: OFF, Invert Tilt: OFF. Below this is a table with columns: Parameter, Address, Home, Snap, and DMX. The first row shows 'Intens' with an address of '385 [1/385]', a home value of '0', and a DMX value of '0'. A yellow circle highlights the address '385 [1/385]' and a yellow arrow points to it with the text 'Click to Go To About Address'. On the right side, there is a sidebar with buttons: Part, Current Values, Background, Moves, Usage, Patch (highlighted with a yellow box), Fixture Notes, and Lamp Controls.

Parameter	Address	Home	Snap	DMX
Intens	385 [1/385]	0		0

**{Fixture Notes}** displays information found in the fixture library such as:

- Revision Number
- Release Date
- Alternate Names
- Usage Notes

**{Lamp Controls}** displays controls for the lamp, available RDM commands, or other parameters of the device (if it is a moving light).

## [About] Address

Press **[About]** to put the CIA into About mode. When an address is selected, the information below is displayed. You can select the information you wish to view from the buttons located on the right side of the CIA. Additional buttons may display based on RDM and Sensor Feedback if enabled. The buttons are:

**{Address}** displays the following information:

- Address number (displayed as straight address and port/ offset)
- Dimmer label (if any)
- Associated channel number, which is a hyperlink to the **[About]** channel display.
- Part number (if any)
- Notes
- Output value (sACN, Net2, ArtNet, Avab UDP, or DMX)
- Current output value and source of output
- Parameter controlled by the address
- Home Value
- Basic patch information
- Extended patch information (if available)
- If it is a scroller, color/ gobo wheel, the assigned scroll or wheel is indicated
- Information stored in the Text 1 through 10 and the Notes fields in **Patch>Database**

**{Next Part}** and **{Last Part}** will advance to the next part or go back to the previous part. This only displays for addresses with parts.

**{Go To Patch}** is a shortcut to edit the patch for the address selected. This will open up the patch display.

**{Fixture Notes}** displays the following information:

- Revision number
- Release date
- Open issues list (if available)
- Usage notes including switch settings and configuration (if available)
- Alternate fixture names (if any)

**{Lamp Controls}** displays controls for the lamp or other parameters of the device (if it is a moving light).

**{Next/ Last Unpatched}** will allow you to see what addresses closest to the current address are currently unpatched.

**{Dimmer Feedback}** - appears when the current address is patched to a dimmer in an ETC Sensor rack with a CEM+ or CEM3. Sensor feedback must be enabled. See [Interface Protocols \(on page 464\)](#) and [Errors and Warnings \(on page 132\)](#) for more information.



**Note:** For Sensor feedback, the CEM+ must be running software version 3.0 or later.

---

**{Dimmer Feedback}** displays the following information:

- Name (dimmer name)
- Module type
- Rack/Position
- Rack dimmer level (displayed as a percentage)
- Rack dimmer source

- Recorded load
- Actual load

{Dimmer Feedback} displays the following information, which can be modified from Eos by clicking on the value and entering in a new value:

- Firing Mode
- Control Mode
- Curve
- Threshold
- Scale Minimum
- Scale Maximum
- Preheat Enable
- Preheat Timing
- Advanced Features (AF) Enable

Eos support the following softkey commands from this display:

- {Ignore Errors}
- {Clear Errors}



**Note:** Clearing CEM+ or CEM3 errors from Eos will be temporary unless the errors have been fixed at the CEM+ or CEM3. Errors displayed on Eos will clear on their own once they have been cleared from the CEM+ or CEM3. Some CEM+ or CEM3 errors can only be cleared at the CEM+ or CEM3.

{Device Details} - appears when the current address is patched to a RDM device. RDM devices must be enabled through the ECU and discovered through the patch. See [RDM \(on page 465\)](#), [{Patch} Display and Settings \(on page 123\)](#), and [Errors and Warnings \(on page 132\)](#).

{Device Details} displays the information that it receives from the device and allows some changes to be made to:



**Note:** Changes may take a few seconds to make. They will propagate to the RDM device and then back to the console's patch and about displays.

- Device Label (displayed at the top by the address number)
- DMX Address (can be changed in this display by clicking on the property or value)



**Note:** Changing the address can not cause any part of the fixture to move to a different universe or communication with the device may be lost. The universe is set into the gateways port configuration.



**Note:** Details displayed will vary based on the device.

- DMX Label (same as the device label, but the label can be changed here by clicking on the property or value)
- Type
- Manufacturer
- Device ID
- Footprint
- Version
- Lamp State
- Lamp Hours



- Head DC Voltage
- Lamp On/Off
- Gel Distance Traveled
- Gel2 Distance Traveled
- Fan RPM
- Ambient Temperature
- Gel Temperature
- Device Errors (will only display if there are current errors)
- Clear Errors

Device Errors are displayed in four different colors depending on severity.



**Note:** Color severity is determined by the device manufacturer.

- Gray - unknown or not an error
- White - Advisory
- Yellow - Warning
- Red - Error

## [About] Cuelist

The following information will be displayed when a cue list is selected:

- Cue List Attributes
- Active Cue
- The number of cues in the list (Multipart cues are only counted once)
- First cue in the list
- Last cue in the list
- Partition
- Playback number and physical fader location of the cue list
- Channels currently controlled in live by the cue list
- Channels with any intensities above 0 in the cue list
- Channels with Parameters stored in the cue list but no intensities

## [About] Cue

**Cue 1**

Timing - Up: 5 Down: 5 Focus: 5 Color: 5 Beam: 5  
 Flags - Mark: None Block: None Assert: None Allfade: No Preheat: None  
 Attributes - Follow: None Link: None Loop: None Curve: None Rate: 200%  
 Num Moves - Intensity: 29 Focus: 12 Color: 27 Beam: 40  
 Status - Running On Fader Master (U0) (0.0 Remaining) [.]aA

Intensity Moves	Live NP Moves	Dark NP Moves	Effects	External Links	Discrete Time/Delay
1>4 6>20 46>51 6...	6>20 61>64			Q5 / 1	

The following information will be displayed when a cue is selected:

- the cue number
- timing data for the cue (including discrete timing)
- flags
- attributes
- number of moves per IFCB provided by the cue

- current status of the cue
- intensity moves
- live NPs moves
- dark NPs moves.
- any effects running
- external links
- all the channels in that cue that have discrete or delay times

## [About] Curves

When a curve is selected, the following information will be displayed:

- curve number
- the curve label (if any)
- the channels that use the curve in patch
- the channels that use the curve as a fan curve
- the cues/cue parts that use the curve

## [About] Effects

When an effect is selected, the following information will be displayed:



**Note:** To view About Effect in live, the effect must be running.

- 
- effect number
  - effect label (if any)
  - list of submasters that use the effect
  - list of cues that use the effect



**Note:** Any cues or submasters that have overrides, such as rate, for the effect will display an \*.

---

## [About] Groups

When a group is selected, the following information will be displayed:

- group number
- the group label (if any)
- the channels in the group

The **{Ordered}** and **{Numerical}** softkeys can be used to change the display view in About Groups.

## [About] Submaster

The following information will be displayed when a submaster is selected:

- The submaster number
- Label (if any)
- Current value
- Mode (additive, inhibitive, or effectsub)
- Fader (proportional or intensity master)
- HTP or LTP
- Exclusive
- Priority

- Timing
- Fader Pages
- Channels in Submaster
- Effects assigned

## [About] Macro

**[About]** Macro display shows a list of cues that will execute a selected macro. To view this display, you must be in the Macro Editor Display. While in that display, press **[About]** and then select the macro by using a mouse or touchscreen.

## [About] IFCB Palettes

The following information will be displayed when an intensity, focus, color, or beam palette is selected:

- the number of cues the palette is used in
- the number of presets the palette is used in
- the number of channels
- the first cue the palette is used in
- the last cue the palette is used in
- the number of cue lists that use the palette

**{Usage}** displays the following information about palettes:

- Number of cues that move
- List of channels that use the palette in a cue
- List of channels stored in the palette that are not used in a cue
- List of cues in which the palette have a move instruction
- List of effects that use the palette
- List of presets that the palette is stored in

## [About] Presets

When a preset is selected, the following information will be displayed:

- the number of channels
- the first cue the preset is used in
- the last cue the preset is used in
- the number of cue lists that use the preset

**{Usage}** displays the following information about presets:

- Number of cues that move
- List of channels that use the preset in a cue
- List of channels stored in the preset that are not used in a cue
- List of cues in which the preset have a move instruction
- List of effects that use the preset

## [About] Color Path

The following information will be displayed when a color path is selected:

- The color path number
- Label (if any)
- Channels that use the color path
- Cues that have moves that use the color path
- Number of cue lists the color path is used in

See [Color Path \(on page 187\)](#) for more information.

## [About] Live

Pressing [Live] while holding [About] will display currently active DMX values, instead of a percentage value.

Double-tapping [Live] while holding [About] will latch this view. Press [About] to disable it again.



**Note:** An asterisk after levels indicates that fixture is patched outside of your current partition, or above the current allowed output count.

---

# Chapter 22

## Storing and Using Curves

---

About Curves .....	378
Creating a Curve .....	379
Editing Curves .....	379
Applying a Curve To Channels In Patch .....	380
Curves Applied to Cues .....	380
Applying a Curve To Scroller Fans .....	381
Delete a Curve .....	381

## About Curves

A curve is a relationship between the timing of a fade and the output level of a cue, cue part or dimmer at each point of time during that fade. By using a non-linear curve, you can create a variety of effects, accommodate variations and deficiencies in your lighting equipment, alter the transition ramp and protect equipment from stress.

You may apply curves to dimmers in patch. Curves may also be applied to cues, to cue parts, and to scroller fans. When applied to a cue, the curve impacts only the intensity moves in that cue. When applied to a cue part, the curve impacts all parameter moves stored in that cue part.

When applied in patch, the intensity transition will follow the ramp defined by the curve during its fade. This value is determined by referencing the output value of the curve at that percentage and outputting the curved level rather than the percent level. Up to 100 points of delineation can be established in a curve, each with its own intensity value if desired.

When applied to a cue, the “percent completion” of the cue is determined by applying the curve’s output level as the percent completion for all fade calculations. For single-part cues, the calculation applies only to intensity. For multipart cues, however, the curve applies to all parameters in the part.

When applied to a scroller fan, the output of the fan will be controlled by the intensity of the channel.

Curves can also be applied to fixtures with non-intensity parameters (NPs). When a channel with NPs is selected in **Patch > Attributes > Curve**, individual buttons for each available parameter will be displayed in the CIA. Click one or more buttons to apply a curve to the desired parameter (s).

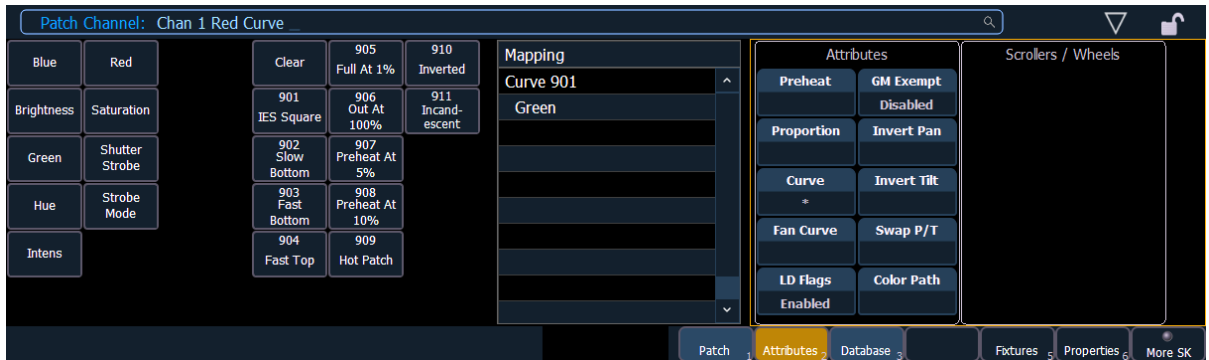

Eos provides ten pre-programmed, commonly used curves. They can be edited or copied to a new curve location. When a pre-established curve is deleted, it will return to its original state.

The curve editor can be accessed by pressing **[Tab] [2] [1]** or **[Displays] {Curve}** or from the browser, **Browser>Record Target Lists>Curves**. When selected, the curves list will open as a separate tab and the CIA will show the graphical output of the first curve in the list.

You can scroll through the list using the **[Next]** and **[Last]** keys, or you can specify a curve in the command line.

- **{Curve} [9] [0] [4] [Enter]** - selects curve 904 from the list and displays its shape in the CIA.



## Creating a Curve

When you have opened the curves display (see [About Curves \(on the previous page\)](#)), you can select a curve or create a new curve by pressing:

- **{Curve} [x] [Enter]**

If the curve is already stored, the contents are displayed in the CIA. If this is a new curve, a linear curve is displayed.

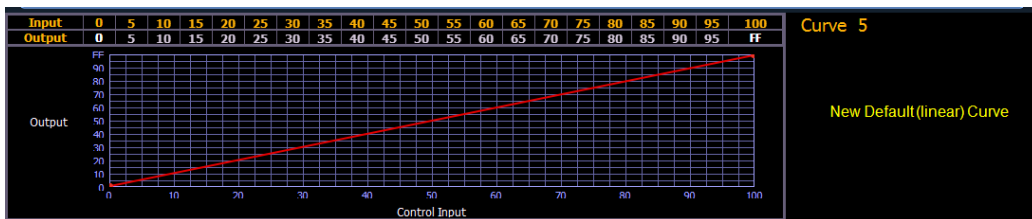
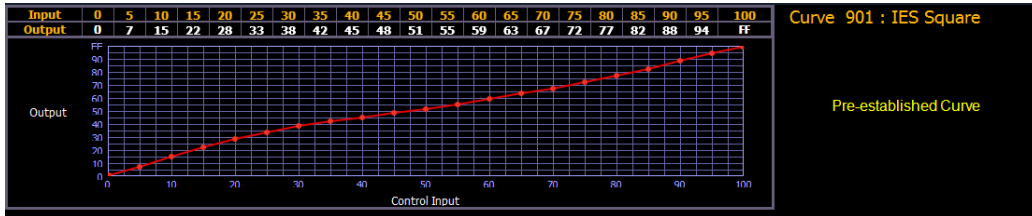

## Editing Curves

### Using the Keypad

Once selected and displayed in the CIA, you can edit a curve from the keypad. Points are established in increments of five. You can add more points from the keypad.

- **[3] [At] [1] [Enter]** - adds control input point "3" and sets its curve level at 10%.
- **[7] [7] [At] [Full] [Enter]** - adds control input point "77" and sets its curve level at full.

You can specify points and adjust their levels in the command line or you may use the keys below to alter the curve:

- **[Page ▶]** - selects the next fade completion point.
- **[Page ◀]** - selects the previous fade completion point.
- **[Level Wheel]** - adjusts the output level of the selected point.
- **[Page ▲]** - raises the selected point's output by 1%.
- **[Page ▼]** - lowers the selected point's output by 1%.
- **[Full]** - sets the selected point's output to full.
- **[Out]** - sets the selected point's output to zero.
- **[+ %]** - raises the selected point by the amount for **[+ %]** established in setup.
- **[- %]** - lowers the selected point by the amount for **[- %]** established in setup.

### Using a Touchscreen

Once a curve is displayed in the CIA, you can press **{Edit}** to edit the curve in the editor display.

In the curve editor you can trace the desired shape of the curve using your finger or a mouse on the touchscreen. As you progress through drawing the curve, intensity values will be added for existing points on the curve. If you add points to the curve (from the keypad) those points will be adjusted as well.

You can also toggle between an “interpolated” or “stepped” curve shape. Eos defaults to “interpolated”. To switch to “stepped”, press the **{Stepped}** softkey. Once pressed, this softkey changes to **{Interpolated}**, which allows you to switch back.

Below are two examples of the same curve. The first is stepped and the second is interpolated.

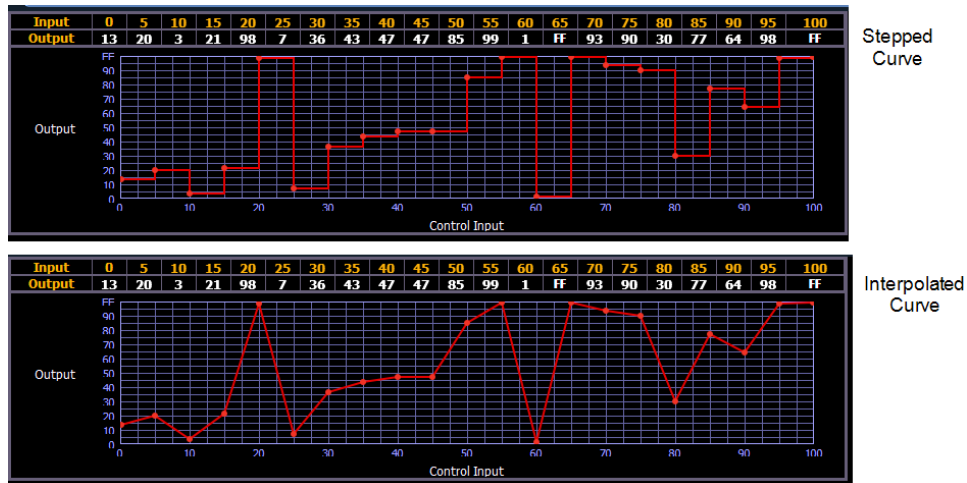

## Clearing the Curve

At any time, you can clear a curve from the curve editor display by pressing the **{Clear Points}** softkey. This will return the curve to its original linear shape or to its default shape if it is a pre-established curve.

## Applying a Curve To Channels In Patch

Curves can be applied to any intensity parameter in patch. Once added, the curve number appears in the channel’s “Curve” column of the patch display. Pressing **{Curve}** in **Patch>Attributes** will display a list of available curves.



**Note:** On Eos, you can also access the patch display by pressing **[Address/Patch]** twice.

- **[Patch] {Attributes} [1] {Curve} [9] [0] [1] [Enter]** - applies curve 901 to channel 1 intensity.
- **[Patch] {Attributes} [2] [Thru] [8] {Curve} [2] [Enter]** - applies curve 2 to intensity for channels 2 thru 8.
- **[Patch] {Attributes} [1] {Curve} [At] [Enter]** - removes the curve from channel 1.

## Curves Applied to Cues

Curves can also be applied to cues or cue parts in Live/ Blind. This affects the percent completion of the cue/ part by applying the curve’s output level as the percent completion for all fade calculations. Once added to a cue, the curve number appears in the cue’s “Curve” column of the cue list in the playback status display.



- [Cue] [5] {Attributes} {Curve} [4] [Enter] - applies curve 4 to cue 5.
- [Cue] [4] [/] [6] [Thru] [9] {Attributes} {Curve} [9] [0] [6] [Enter] - applies curve 906 to cues 4/6 through 4/9.
- [Cue] [5] {Attributes} {Curve} [At] [Enter] - removes any curve from cue 5.
- [Cue] [8] [Part] [3] {Attributes} {Curve} [6] [Enter] - applies curve 6 to part 3 of cue 8.

## Applying a Curve To Scroller Fans

Curves can also be applied to a scroller fan. When applied to a scroller fan, the output of the fan will be controlled by the intensity of the channel. To apply a curve to a scroller fan, go to **Patch>Attributes>{Fan Curve}**. See [Scroller Fan Curves \(on page 120\)](#)

## Delete a Curve

While in the curve display, you can delete a curve in the following ways:

- [Delete] {Curve} [3] [Enter] [Enter] - deletes curve 3 from the list.
- [Delete] {Curve} [9] [0] [1] [Enter] [Enter] - since curve 901 is a pre-established curve, this command will return curve 901 to its default state, thereby removing any edits to it.
- [Delete] [Enter] - deletes the currently selected curve.



# Chapter 23

## Storing and Using Snapshots

---

About Snapshots .....	384
Recording Snapshots .....	384
Recalling Snapshots .....	386
Editing Snapshots .....	386
Deleting Snapshots .....	387

## About Snapshots

Snapshots are record targets that store the current state of the Eos control surface and external monitor configuration. These can then be recalled to instantly reset the console and displays to the state stored in the snapshot. You can choose which parts of the front panel and displays you wish to store as a part of the snapshot.

When you record a snapshot, aspects of the Eos user-interface, based on user-preference, are stored so that you can recall them in the future. This allows you to bring the console back to a desired state quickly.

Snapshots can be used on RPU or RVI to change what is currently displayed on the external monitors and how that information is displayed.

Snapshots contents are global. They can be stored and recalled on any control interface, other than Net3 RFRs. When recorded, they store the relevant settings of the device initiating the record. When recalled, they recall only the controls that are appropriate on the device the snapshot is recalled.



**Note:** Snapshots that store the faders do **not** include the active cue in a fader. They only include pending cues and fader attributes.

Snapshots of just a single monitor can also be recorded. See [Single Monitor Snapshots \(on page 45\)](#) for more information.

## Recording Snapshots

To store the current state of the console, record a snapshot.

- **[Record] [Snapshot] [1]** On Element 2, you will need to use the **{Snapshot}** softkey.

When recording a snapshot, you will see a preview of all of the displays as they will be recorded in the snapshot. You can choose to select/ deselect various components, monitors, frames, etc from your snapshot.



On Element 2, the snapshot display is different, and you will only have the visible workspaces and all workspaces option available.

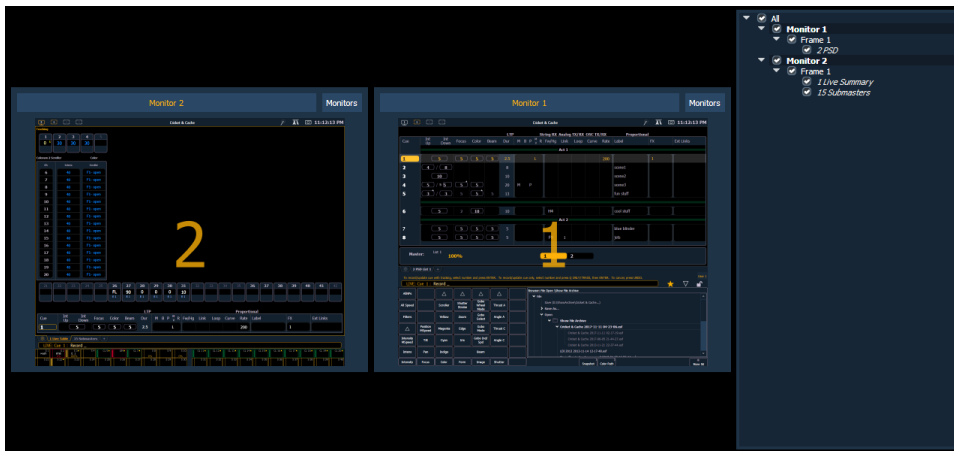

From the snapshot menu, the following options are available:

- **Visible Workspaces** - includes only the visible workspaces.
- **All Workspaces** - include all workspaces, including those not visible at the time of recording.
- **Faders** - captures the current state of the faders including: fader page mapping, position of all submasters, and pending cues based on configuration.
- **Encoders** - records the current page of the encoders.
- **Filters** - records the current setting of the record filters.
- **Direct Selects** - when used without visible workspaces selected, this option will recall all direct select tabs and their settings.
- **Favorite** - the snapshot will display in the quick access window. See [Quick Access](#) for more information.
- **Custom DS** - a snapshot will recall the targets that each of the custom direct select buttons are mapped to, unless the snapshot does not have custom direct select button mapping.
- **Color** - assign colors (**{Red}**, **{Green}**, or **{White}**) or **{Dark}** to a snapshot. **{Dark}** assigns no color to the snapshot. The colors will display beside the snapshots name in a direct select, and/or if that snapshot has been assigned to one of the customizable hardkeys on Eos Ti, Gio, Gio @ 5, and RPU.
- **Reset** - sets the menu back to its defaults.

You can choose to include or exclude monitors, frames, and tabs in the area below the snapshot menu by checking or unchecking in the list.

When a frame or tab has been excluded, an - icon will display to indicate that not everything on that monitor will be saved. A checkmark icon will display when everything on the monitor will be saved.

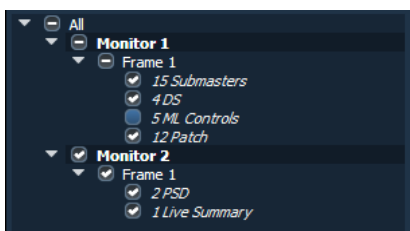

Monitors and frames can also be selected or deselected in the preview area. Use the **{Frames/Monitors}** button to select whether you will see monitor or frame numbers in the preview area.

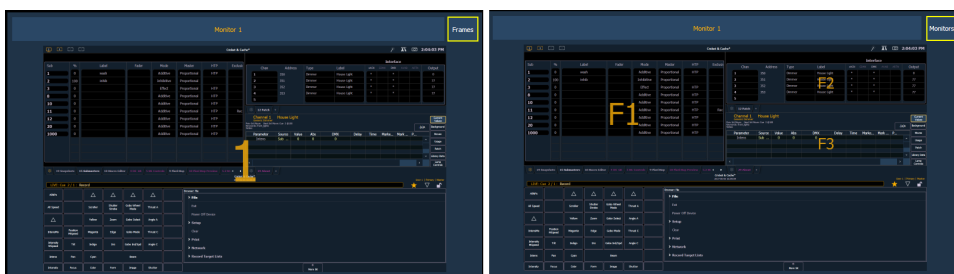

When a monitor or frame has been deselected, it will be greyed out. Deselected frames will also have a small red circle with a slash on them.

See [Workspace Layout Menu \(on page 42\)](#) for information about arranging your monitors for better control when creating snapshots.

## Recalling Snapshots

When snapshots are recorded, you can view them in the snapshot list. To view the list:

- press [Snapshots] [Snapshots] On Element 2, press {Snapshots} {Snapshots}

-or-

- press [Tab] [1] [9]

-or-

- navigate to **Browser>Record Target Lists>Snapshots**.

Snapshots can be recalled in the following ways:

- from the keypad/ command line - [Snapshots] [5] [Enter]/ {Snapshots} [5] [Enter]
- from cues using the execute list
- from a recorded macro instruction
- from the direct selects - {Snapshot 4}

Since snapshots can be recalled from any device (except RFRs) on the Eos Family network, snapshots may be affected by the type of device they are recalled on. If the recalling device does not have the same physical layout or has other limitations that differ from the recording device, Eos will map the snapshot to the best of its ability.



**Note:** *In a system with multiple users, it is recommended that you allot discrete snapshot numbers for each user. Since snapshots are global and can be recorded/recalled from most devices, assigning numbers for each user will ensure their snapshots are stored and edited properly for their device.*

## Editing Snapshots

To edit or preview the contents of a snapshot, open the snapshot list.

- press [Snapshots] [Snapshots] On Element 2, press {Snapshots} {Snapshots}

-or-

- press [Tab] [1] [9]

-or-

- navigate to **Browser>Record Target Lists>Snapshots**.

You can use **[Next]** and **[Last]** to navigate the list or you may specify a snapshot in the command line.

Once a snapshot is specified, the list displays five columns, one for each element. You may change the enabled elements by pressing the CIA buttons or the softkeys found beneath the CIA. If an element is added to the command line using the softkeys, it will be enabled when **[Enter]** is pressed. All other elements will be disabled.

Snapshots can be labeled in the snapshot list by selecting the snapshot and pressing **[Label]** or by selecting the Label column.

### **Example:**

- `<Snapshots> [3] {Monitors} [Enter]`

This command will enable the monitors for snapshot 3 **and disable any other elements.**

## **Deleting Snapshots**

You may delete snapshots using the following syntax:

- `[Delete] [Snapshots] [2] [Enter] / [Delete] {Snapshots} [2] [Enter]`
- `[Delete] {Snapshot 5}` - selects a snapshot from the direct selects to delete it.





# Chapter 24

## Storing and Using Macros

---

About Macros .....	390
Store a Macro from Live .....	390
Using the [Learn] key .....	390
Macro Editor Display .....	391
Create a New Macro from the Display .....	393
Edit an Existing Macro .....	393
Play a Macro .....	394
Stop a Macro .....	395
Delete a Macro .....	395

## About Macros

Eos provides you with the ability to record macros, which allow you to compose a series of programming actions and be able to execute them later by recalling the macro.

Macros are comprised of any series of button presses (both hard and softkeys), screen commands and events. Eos provides you with the macro feature to simplify complex or repetitive console programming and operating tasks that you perform often.

When you record the series of button presses to a new macro, you can later play it back by simply pressing the macro direct select button, running it from a linked cue, accessing it from a connected show control system, remotely triggering the macro, or running it from another recorded macro.

You may create up to 99,999 macros either from live, using the macro **[Learn]** mode to record a sequence of keystrokes as you perform the operation, or you can create a macro from within the macro editor display, entering and editing keystrokes into the macro content editor without actually executing the instructions.

The macro editor display contains a listing of all recorded macros including labels and the contents of the macros stored. All macro editing is accomplished from the macro editor display.

## Store a Macro from Live

The most effective way to store a macro is from live mode using the macro **[Learn]** mode to record a sequence of button presses as you enter them. You can include any button press on the console (hard key or soft key), except **[Macro]**, the arrow keys, **[Escape]**, **[Select]**, and **[Learn]**.

## Using the **[Learn]** key

Pressing the **[Learn]** key while in live mode places the console in macro learn mode. The **[Learn]** key flashes and the CIA displays "Learning" above the command line. Assign a number identifier (from 1 to 99,999) to the Macro using the control keypad and press **[Enter]**. The CIA flashes "Learning Macro ####" above the command line. This indicates that the console is ready to record the macro.



**Note:** *It is helpful if you plan your macro content in advance of the macro record process. While in learn mode, each button press is recorded as content, even the **[Clear]** button if you have mistaken a keystroke. There is no way to fix a content error in live mode, but you can rerecord the macro as needed, or you can edit the recorded macro in the macro editor, removing any unneeded commands. See [Edit an Existing Macro \(on page 393\)](#)*

---

Begin writing the sequence of button presses and events for the macro record. When you have finished with the series of events and button presses, press the **[Learn]** key again to exit macro learn mode.

Examples of a macro record function include:

- **[Learn] [1] [Enter] [Go To Cue] [Out] [Time] [0] [Enter] [Learn]** - records macro 1 with the go to cue out command.
- **[Learn] [5] [Enter] [1] [Full] {Chan Check} [Enter] [Learn]** - records macro 5 with channel 1 at full in channel check mode. To check the next channel in the list, press **[Next]**.
- **[Learn] [4] [Enter] [-] [Sub] [Record] [Learn]** - records macro 4 with instructions to record a target excluding all submaster data.
- **[Learn] [2] [Enter] [-] [Group] [6] {Color} [Record] [Learn]** - records macro 2 with instructions to record a target excluding the color data from group 6.

You can also create a macro in live that bumps submasters across fader pages but first you must have content assigned to the submasters.

### Example:

Write submasters 1 through 5 and 15 through 17, each with its own channel selections at 100%. Then press:

[Learn] [1] [Enter] [Bump1] [Bump2] [Bump3] [Bump4] [Bump5]  
 [Fader Page]  
 [Bump15] [Bump16] [Bump17] [Learn]

Once you have created the macro from Live in **[Learn]** mode, you can easily edit the sequence from the macro editor display. See [Macro Editor Display \(below\)](#).

## Macro Editor Display

Macro editing is accomplished from the macro editor display. As an alternative to recording your macro in live, you may create it from this display instead. Open the macro editor display by pressing **[Macro] [Marco]**, from the browser by navigating to **Record Target Lists > Macro Editor**, or press **[Tab] [1] [8]**.

The display is divided horizontally, the top portion displays the macro contents in detail while the bottom portion lists all macros, including the label and contents. Text that displays in blue indicates a console event, and commands will display in gray text.

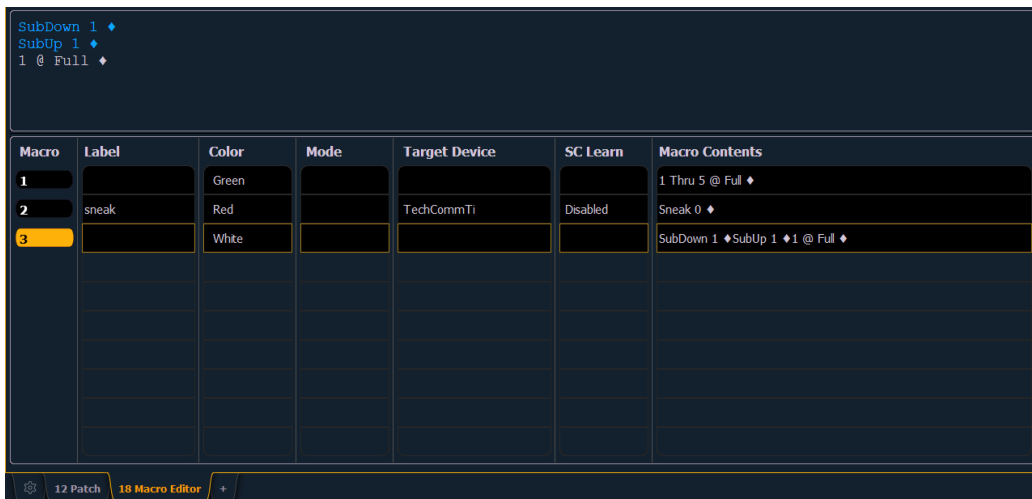

While in the macro editor display, any numeric entry on the command line is assumed to be a macro number. If the macro number entered already exists and **[Enter]** is pressed, the macro list will page to the selected macro and the macro content detail section will display all of the contents of the selected macro. If the macro number entered does not exist in the list and **[Enter]** is pressed, an empty macro will be created with the specified macro number.

While in the macro editor display, the following functions may be performed using the control keypad and softkeys:

- **[Label]** - when a macro is selected and **[Label]** is pressed, the alphanumeric keypad will display on the CIA. Label the macro and press **[Enter]**.
- **[1] [Label] <name> [Enter]** - labels macro 1

- **{Color}** - assign colors (**{Red}**, **{Green}**, or **{White}**) or **{Dark}** to a macro. **{Dark}** assigns no color to the macro. The colors will display beside the macro name in a direct select, and/or if that macro has been assigned to one of the customizable hardkeys on Eos Ti, Gio, Gio @5, and RPU.
- There is also a **{Toggle Blink}** softkey. By default a customizable hardkey will blink when the macro assigned to it is running. This softkey will turn off the blinking if it is enabled and a BD will display in the color column when blinking is disabled.
- **[Delete]** - when a macro is selected and **[Delete] [Enter]** is pressed, you will be prompted to confirm the deletion of the selected macro. To confirm press **[Enter]**, to abort press **[Clear]**.
- **[1] [Delete] [Enter] [Enter]** - deletes macro 1 from the list.
- **[Copy To]** - when a macro is selected and **[Copy To]** is pressed, you will be prompted to enter the macro number that you want to copy the contents of the selected macro to. You will be prompted to confirm the copy process, press **[Enter]** to confirm or **[Clear]** to abort the copy to process.
- **[1] [Copy To] [6] [Enter] [Enter]** - copies the entire contents of macro 1 to macro 6.
- **{Edit}** - when a macro is selected and **{Edit}** is pressed, you will have entered edit mode for the selected macro. See [Edit an Existing Macro \(on the facing page\)](#) for more information. Three notable changes to your macro editor display include:
  - a blinking cursor in the macro content detail portion (top) of the display.
  - "Press **[Select]** to save or **[Escape]** to cancel changes" displays above the command line.
- **{Move To}** - allows you to move and reorganize your macros anywhere in the macro list numerically. You can access **{Move To}** by pressing **[Copy To]** twice.
- For instance, if you have macros 1 through 5 in the list, and you want to move/ change macro 1 to macro 6 so that your most commonly used macros are first in the list, you would press **[1] {Move To} [6] [Enter]**. This leaves only macros 2 through 6 in the list.
- **{Mode}** - allows you to assign different modes for the macro to run in. There are three modes: **background**, **foreground**, and **default**.
- **{Default}**
  - When a macro in default mode is run manually, it runs in the foreground(i.e., the command line) on the device that fired it. When a macro in default mode is executed by a cue or via show control, it runs in the background on the master device.
  - Running a macro on a master device only matters when the macro changes the displays of the device it runs on such as snapshot and flexichannel macros.
- **{Background}**
  - When a macro in background mode is run manually, it runs on the device that fired it but will not affect its command line.
  - A macro in background mode that is run from a cue or via show control will run on the master device but will not affect the master's command line.
  - When a background macro is running and includes a link to another macro, or is currently waiting, pressing the **[Macro]** button will stop it.
- **{Foreground}**
  - When a macro in foreground mode is run manually, it runs on the device that fired it and affects its command line.
  - If a foreground mode macro is fired via show control, it runs on the master device and will affect its command line.
  - If a cue fires the macro, it will run on the device whose user last pressed **[Go]** on that playback. If a foreground macro is fired from a cue that is executed from another cue list, the macro will run on the device that last pressed **[Go]** on the cue's playback but not the playback that triggered the executed cue.

- **{Target Device}** - A macro can have a Target Device assigned to it. This allows a cue to execute a macro only on a certain console.
  - The Target Device can be a device name or User ID. These are assigned to a macro in the Macro Display by using the **{Target}** softkey and either selecting **{Device}** and **{User}**. Pressing **{Target}** will also display a list of connected devices and additional target options.
- {SC Learn}** - enables or disables excluding specific macros from being learned as show control events. See [Adding Events using Learn Mode \(on page 490\)](#) for more information.

## Create a New Macro from the Display

From the macro editor display, enter any unrecorded macro number from 1 to 99,999 and press **[Enter]**. Your new macro number will display in the macro list in numerical order but will not have a label or any contents.

To store the macro contents, select the macro and press **{Edit}**. A cursor appears flashing in the macro content detail portion of the display, ready for you to add the macro content.

### For Example:

Create macro 3. Write the instruction to set all active channels to 50%, then sneak them to their original levels over 10 seconds and last, link to macro 5.

- **<Macro> [3] [Enter]**
- **{Edit}**
- **[Select Active] [At] [5] [Enter]**
- **[Sneak] [Time] [1] [0] [Enter]**
- **[Macro] [5] [Enter]**
- **[Select]**

While in macro edit mode, all keys are entered as content except the macro editor softkeys, arrow keys, **[Escape]**, **[Select]** and **[Learn]** keys.

## Edit an Existing Macro

When you have created a macro using macro learn mode from live or otherwise, you can edit the content of your macro by removing or adding commands and special macro softkey functions (such as wait, loop, and so on).

From the macro editor display, select an existing macro number and press **[Enter]**. The selected macro contents will display the detail section. Press **{Edit}** to make changes to the content.

When in edit mode, the browser changes to display all softkeys available for the system that would otherwise be difficult to find when recording a macro. You can also choose from a list of the most common macro commands.

<<	A	Absolute	Action	Address	After Sunrise	After Sunset	All	All Workspace	Allfade	Always Absolute
>>	Analog	Analog Address	Apply	ArtNet	Assert	Attach	Attribute Mode	Attributes	Attrs Only	AUTO DIM
	AutoBlock Clean	AVAB/UDP	Axis	B	Beam Palette	Before Sunrise	Before Sunset	Bounce	BPM	Break Nested
Common	Broken Mark	Build	Bump	By Type	Can Be	Can't Be	Cancel Edit	Cascade Entry	Cascade Exit	Cell
Softkeys	Center	Chan	Chan Per Group	Check	CIE XYZ	Cleanup	Clear Effect	Clear Points	Close	Cluster
Lamp Controls	CMY	Color	Color Effect	Color Palette	Color Path	Command History	Complete	Cue	Curve	Curve Edit

Next to the softkeys display are paging buttons to page through the available softkeys. When used, these paging buttons will not be stored as content in your macro.

In addition, a new set of macro editor softkeys are displayed while in edit mode including:

- **{Loop Begin}** - inserts a loop start command
- **{Loop End}** - inserts an end command for a loop with a limited number of iterations. An infinite loop is assigned when you use "0" for the iterations.
- **{Wait}** - inserts a pause for a period of time. This needs to be followed with a whole number of seconds.
- **{Delete}** - removes commands from the macro
- **{Wait for Entr}** - inserts a pause in the macro that waits for the **[Enter]** key. Pressing **[Enter]** will resume the macro.
- **{Wait for Input}** - inserts a pause in the macro to allow you to enter data. The pause lasts until you press the **[Macro]** key again. Then the remainder of the macro will be completed.
- **{Done}** - exits macro edit mode. You may also use the **[Learn]** key to enter and exit edit mode.

In edit mode, the cursor in the macro content detail section of the display provides use of the arrow keys to navigate through the existing content list. Use of the arrow keys will not be stored to the macro content.

To add content, place the cursor in the section that you want to insert, then add the command. To delete a command, place the cursor ahead of the content to be deleted, then press the **{Delete}** softkey.

Press **[Select]** when you have completed all editing. Press **[Escape]** to abort.



**Note:** *Macros for options with a toggle action between enable and disable, such as AutoMark in setup, can use the **{Enable}** and **{Disable}** softkeys for creating absolute actions instead of toggles.*

---

## Play a Macro

You can play a macro from the command line, from the direct selects, run it from a linked cue, or from another macro.

To play macro 5 from the command line press **[Macro] [5] [Enter]**. "Running Macro 5" displays above the command line in live while the macro is running.

To run macro 5 from the macro direct selects simply press **{Macro 5}**. "Running Macro 5" displays above the command line in live while the macro is running.

To run macro 5 from cue 1 press:

- **[Cue] [1] {Execute} [Macro] [5] [Enter]**

If you would like to run multiple macros from cue 1, press:

- **[Cue] [1] {Execute} [Macro] [6] [Enter]**
- **[Cue] [1] {Execute} [Macro] [7] [Enter]**

Each macro has to be entered individually. The previous example would result in macros 5 through 7 being executed from cue 1.

To run a macro from another macro, see the example under [Create a New Macro from the Display \(on the previous page\)](#).

## Stop a Macro

If you need to stop a Macro while running (for example, during an infinite loop) you may press **[Escape]** and the macro will stop.

## Delete a Macro

You can delete a macro from the Macro Editor display by selecting the macro and pressing **[Delete] [Enter]**. You will be prompted to confirm the deletion. Confirm by pressing **[Enter]** again, or abort by pressing **[Clear]**.

### Example:

Delete macro 5 from the macro list.

- **[5] [Enter]**
- **[Delete] [Enter] [Enter]**

Or from any display:

- **[Delete] [Macro] [5] [Enter]**





# Chapter 25

## Using Magic Sheets

---

About Magic Sheets .....	398
Magic Sheet Browser .....	398
Navigating a Magic Sheet .....	401
Creating and Editing Magic Sheets .....	402
Limited Expand Mode .....	417
Examples of Magic Sheets .....	418

## About Magic Sheets

Magic Sheets are user created interactive displays that offer customizable views for displaying data and programming. Magic Sheets are comprised of objects that are tied to show data, such as channels and palettes.

The following are two examples of magic sheets. For additional examples, see [Examples of Magic Sheets \(on page 418\)](#).

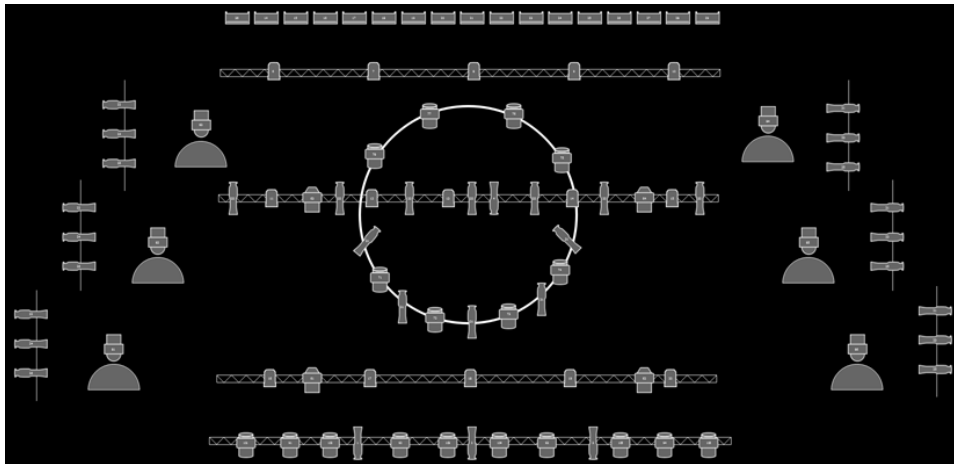
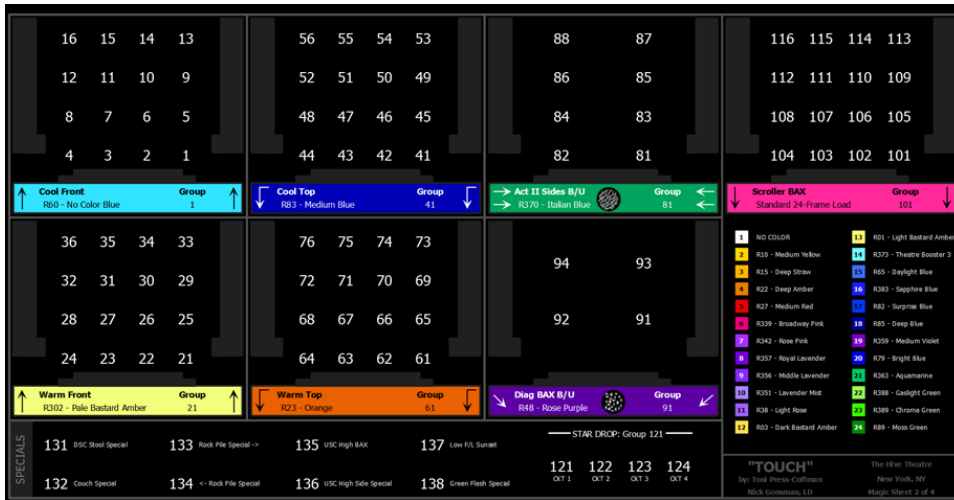

## Magic Sheet Browser

Open the magic sheet browser by pressing **[Tab] [3]**, or by selecting the magic sheet browser icon from the home screen.

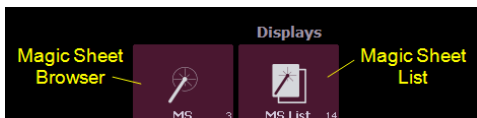

If no magic sheets exist in the show file, the magic sheet browser will be blank except for the New Magic Sheet icon. Click on the icon to open the magic sheet editor.

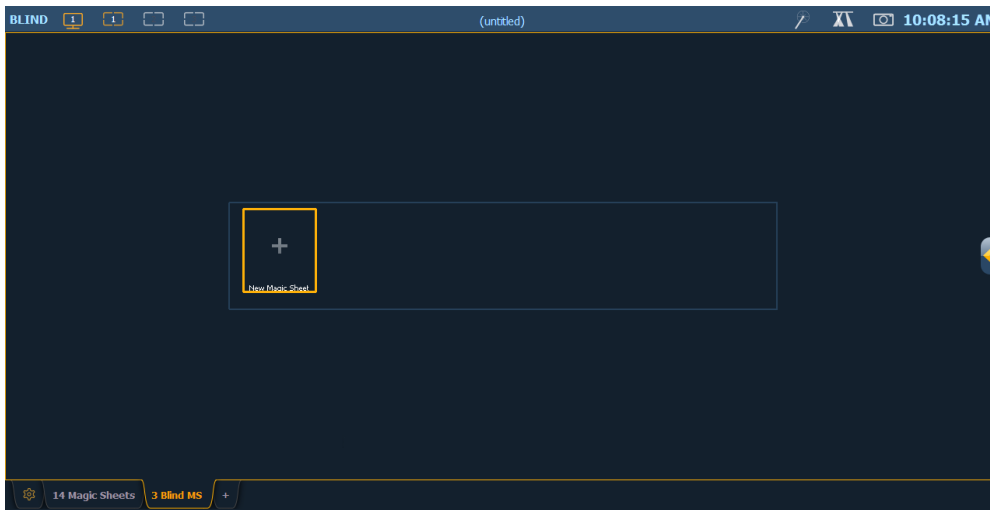

After you have created a magic sheet, you can recall a specific magic sheet, by pressing [Displays] {Magic Sheet} [#] [Enter] or you can navigate to **Displays> Record Targets> Magic Sheet** and press [Select] to open the magic sheet list (see [Magic Sheet List \(below\)](#)).

All available magic sheets will also be shown in the magic sheet browser.

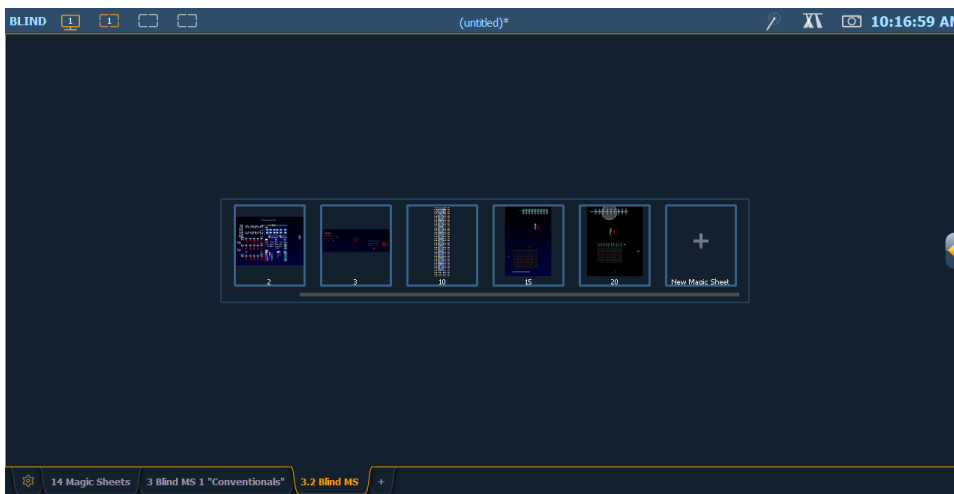

## Direct Selects

Magic Sheets can also be accessed from the direct selects. Clicking on a magic sheet direct select will open the Magic Sheet tab and display the selected magic sheet. Pressing a different magic sheet direct select will change the displayed sheet. See [Using Direct Selects \(on page 68\)](#)

## Magic Sheet List

The magic sheet list can be opened by double pressing {Magic Sheet}, pressing [Tab] [1] [4], navigating within the browser to **Displays> Record Targets> Magic Sheet** and pressing [Select], or using CTRL+S on an external keyboard. The magic sheet list displays a list of all created magic sheets, their labels, and how many views have been saved for each magic sheet. See [Display Tools \(on the next page\)](#) for more information about views.

To label a magic sheet, use the syntax {Magic Sheet} [#] [Label] <name> [Enter].

Pressing **[Label]**, when a label has already been applied to a magic sheet, will display the label on the command line for editing. Pressing **[Label]** a second time will clear the label, or you can press **[Clear]** to remove the label one character at a time.

## Display Tools

The display tools for Magic Sheets are available by either right clicking or double tapping on the Magic Sheet's tab. The tab will also indicate if the Magic Sheet is in Live or Blind.

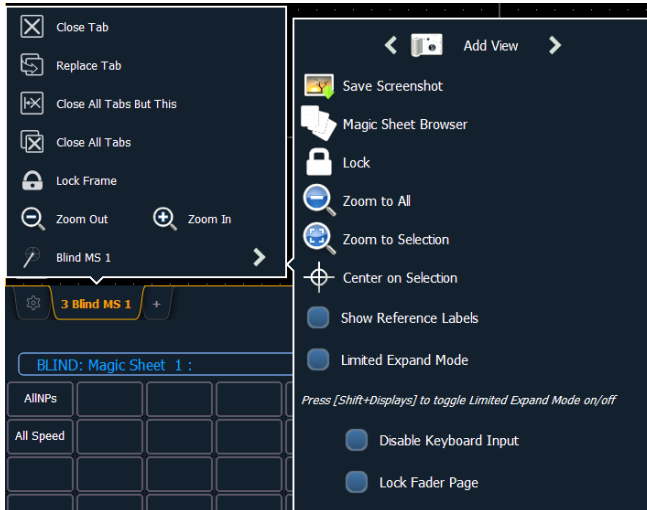

**Note:** You can click and hold or tap and hold on the Magic Sheet's tab to do a zoom to all of the Magic Sheet display.

These tools include:

- **Add View** - different views of the same magic sheet can be saved and recalled. Zoom and pan the display to change the view, and then click **{Add View}** to save. To change views, you can use the arrows in the display tools or multi-touch gestures. You can also press **{Magic Sheet} [1] [/] [2] [Enter]** to view Magic Sheet 1, View 2. See [Multi-Touch Gestures \(on page 402\)](#)
- **Save Screenshot** - saves a .png screenshot of the magic sheet to a hard drive or an attached USB drive.
- **Magic Sheet Browser** - opens the magic sheet browser, which displays thumbnail images and labels for the created magic sheets. The browser can also be opened using multi-touch gestures. See [Multi-Touch Gestures \(on page 402\)](#)
- **Lock** - locks the magic sheet so it cannot be zoomed or panned. This is useful for a customized direct select layout, where you want the buttons to always be in the same spot.
- **Zoom to All** - zooms to show all objects.
- **Zoom to Selection** - zooms to show all selected objects.
- **Center on Selection** - centers the display on the selected objects without changing the zoom level.
- **Show Reference Labels** - when enabled, channel objects that reference record targets (such as presets or palettes) with labels will have their labels displayed in the Magic Sheet rather than their target type and number. **[Shift] & [Label]** can be used to temporarily toggle between views.

- **Limited Expand Mode** - allows a magic sheet to be displayed at fullscreen. See [Limited Expand Mode \(on page 417\)](#) for more information.

The following options are only available while in Limited Expand Mode:

- **Disable Keyboard Input** - disables input from the facepanel and an external keyboard. Fader and macro buttons will still work.
- **Lock Fader Page** - locks the fader page to the currently displayed one.

## Navigating a Magic Sheet

Magic sheets can be navigated using a mouse, a keyboard, a touchscreen, or a multi-touch touchscreen. The drag and drop function for placing objects is a single touch action or done using a mouse.

Additional mouse commands include:

- **Left Click** - selects an object.
- **Right Click** - pans the display.
- **Wheel** - zooms the magic sheet.
- **[Shift] & Wheel** - provides a fine zoom of the magic sheet.

Selecting from left to right will open the blue window selection box. This selects any object that is completely inside the box. This can be done with a single touch or using a mouse.

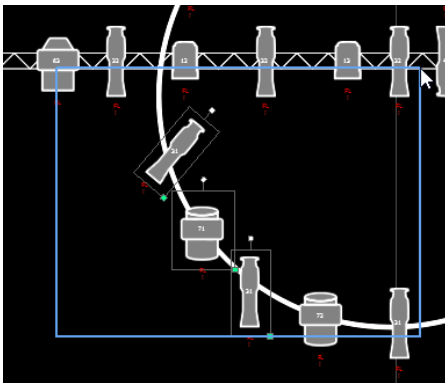

Selecting from right to left will open the green crossing selection box. This selects any object that either crosses the boundary line of the box or is completely inside of it. This can be done with a single touch or using a mouse.

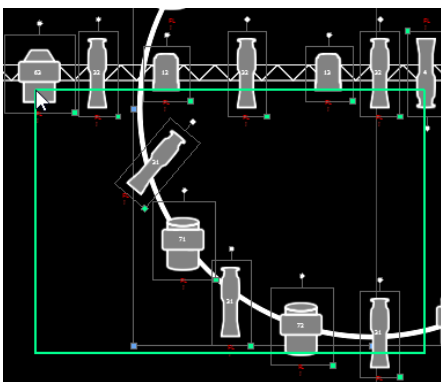

## Multi-Touch Gestures

The following multi-touch gestures can be used with an external multi-touch touchscreen or the on-board monitors on Eos Ti, Gio, and Gio @ 5. Multi-touch is not available on the on-board monitors of Eos.

- **Scroll** - touch with two fingers to move around the page.
- **Zoom Out** - touch with two fingers and then move your fingers toward each other.
- **Zoom In** - touch with two fingers and then move your fingers away from each other.
- **Zoom to All** - double tap with two fingers.

The following multi-touch gestures can be used with monitors that support 3 or more simultaneous touches:

- **Jump to Previous View** - use three fingers to swipe upwards or to the right.
- **Jump to Next View** - use three fingers to swipe downwards or to the left.
- **Magic Sheet Browser** - tap with three fingers to open the browser.

## Keyboard Shortcuts

With an external alphanumeric keyboard attached, the following keyboard shortcuts can be used:

- **ARROW KEYS** - move selected item or navigate when nothing is selected.
- **SHIFT** - move/rotate item without snapping to grid.
- **SHIFT + mouse wheel** - provides a fine zoom of the magic sheet.
- **CTRL+S** - double tap to open the magic sheet list.
- **CTRL+A** - select all
- **CTRL+C** - copy
- **CTRL+V** - paste
- **CTRL+X** - cut
- **CTRL+G** - group
- **CTRL+SHIFT+G** - ungroup
- **DELETE** - delete
- **ESC** - finish line/polygon creator or close tab.

## Creating and Editing Magic Sheets

Pressing the edit button on the right hand side of the magic sheet display will open the editing tools.



The main area of the magic sheet will display a grid to aid with layout. The editing tools will be displayed on the right side of the magic sheet. The editing tool window is divided up into three areas: layout tools, the MS Object Library, which is made up of four tabs that contain the MS Objects, and the MS Object Properties.



**Note:** To see a description of a tool or object, hover your cursor over it. Its title will display after a second or two.

You can drag and drop objects onto the magic sheet, or you can use the layout tools to create arrays of objects.



**Note:** Holding down **[Shift]** while placing an object will bypass the snap to grid behavior.

## Quick Save

Clicking on the **{Quick Save}** button allows you to save an undo restore point for the magic sheet you are working on. Once saved, a green check mark will temporarily appear next to the **{Quick Save}** button.



It is recommended that you click **{Quick Save}** before making any major changes to the magic sheet that you think you might want to undo. **[Undo] [Enter]** will take the magic sheet back to the last undo restore point. An undo restore point is also set whenever you exit the editor.

Quick saving a magic sheet will also send any changes made to the magic sheet to all the devices in a multi-console system.

## Layout Tools



The layout tools are divided into four areas:

- [Edit Mode \(on the next page\)](#)
- [Zoom \(on the next page\)](#)
- [Alignment \(on page 405\)](#)
- [Ordering \(on page 407\)](#)

## Edit Mode

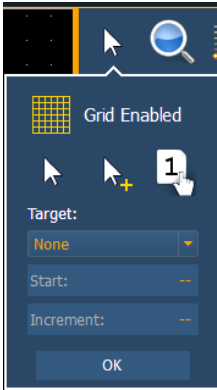
Clicking on the arrow will open the edit mode options, which include:



- **Grid Enabled** - toggles between a grid being displayed and no grid. With the grid enabled, the magic sheet will also have a snap to grid behavior when placing objects.
-  **Normal** - allows for dragging and dropping of objects from the object list.
-  **Quick Layout** - allows you to place more instances of a selected object. When finished, click the **{Done}** button or change the layout mode to normal.
-  **Quick Number** - used to quickly assign target numbers to objects. While in quick number mode, clicking on an object will assign the selected target and increment the numbers as specified in the target section of edit mode.
- **Target** - used to specify object, starting target number, and incrementation for use in quick number mode.
- **Object** - assigns the object from the list.
- **Start** - assigns the starting target number.
- **Increment** - assigns what incrementation the target numbers will use after the start number.

### Example:

When incrementing multicell fixtures on a magic sheet, the following methods can be used:

- **Start: 1.1 Increment: 1**
  - Gives you these channel numbers: 1.1, 2.1, 3.1...
- **Start: 1.1 Increment: 0.1**
  - Gives you these channel numbers: 1.1, 1.2, 1.3...
- **Start: 1.1 Increment: 1.1**
  - Gives you these channel numbers: 1.1, 2.2, 3.3...

## Zoom

Clicking on the magnifying glass will open the zoom mode options, which include:



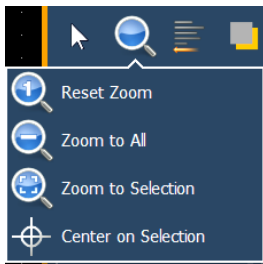

- **Reset Zoom** - sets the zoom level to 1:1 and centers the magic sheet.
- **Zoom to All** - zooms to show all objects.
- **Zoom to Selection** - zooms to show all selected objects.
- **Center on Selection** -centers the display on the selected objects without changing the zoom level.

## Alignment

Clicking on the alignment icon will open the alignment options, which include:

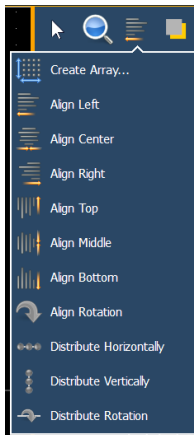

- **Create Array**- allows you to create arrays of objects. After placing one object of your choice, click on **{Create Array}** to open an additional window for choosing what array type you want to use.
- **Rectangle** - will layout a rectangle array of objects. You can define the rows, columns, and spacing.

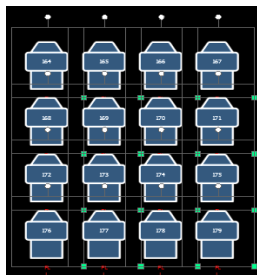

- **Circle** - will layout a circle array of the objects. You can define the numbers of objects and the size of the circle.

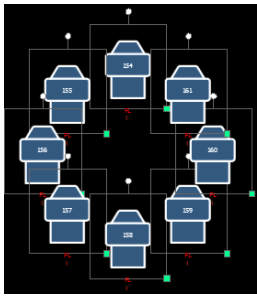

- **Align Settings** - allows you to align objects either to the left, right, center, or top, middle, bottom.

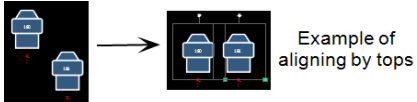

- **Align Rotation** - allows you to select multiple objects and align their rotation to the first object selected.

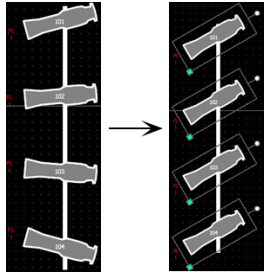

- **Distribute Horizontally** -allows you to distribute objects horizontally at an equal distance apart between two objects. Set the distance you would like by placing the first and last objects. Then with all objects selected that you wish to distribute (including the first and last ones you positioned), click the **{Distribute Horizontally}** button.

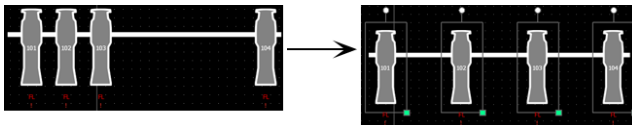

- **Distribute Vertically** - allows you to distribute objects vertically at an equal distance apart between two objects. Set the distance you would like by placing the first and last objects. Then with all objects selected that you wish to distribute (including the first and last ones

- you positioned), click the **{Distribute Vertically}** button.

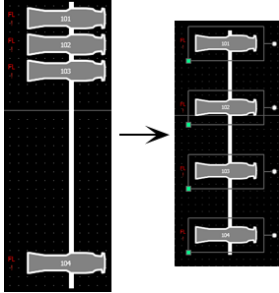

- **Distribute Rotation** - allows you to distribute objects at an equal rotation between two objects. Set the level of rotation you would like by placing the first and last objects at a rotation. Then with all objects selected that you wish to rotate (including the first and last ones you positioned), click the **{Distribute Rotation}** button.

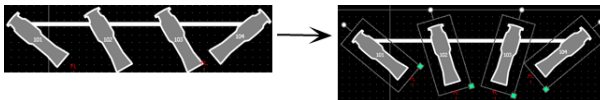

## Ordering

The objects can either be placed on their own or stacked on top or beneath of each other.

Clicking on the order icon will open the ordering options, which include:

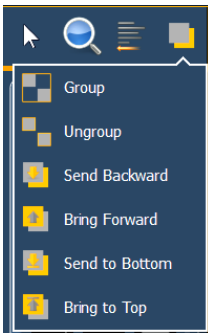

- **Group** - allows you to group objects together so they can be moved and rotated like a single object.
- **Ungroup** - removes grouping.
- **Send Backward** - will send an object back.
- **Bring Forward** - will send an object up.
- **Send to Bottom** - will send an object beneath all other objects.
- **Bring to Top** - will stack an object on top of all other objects

## Magic Sheet Object Library

The objects section of the editing tools has four tabs:



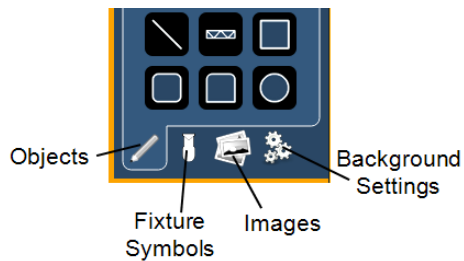





- [Magic Sheet Objects \(on the next page\)](#)
- [Fixture Symbols \(on page 409\)](#)
- [Images \(on page 410\)](#)
- [Background Settings \(on page 411\)](#)



## Magic Sheet Objects

The following table contains the various magic sheet objects located in the first tab, and a brief description of what they do. Settings for objects can be adjusted in the [MS Object Properties \(on page 414\)](#) area.

Channel		acts as a direct select for a channel.
Group		acts as a direct select for a group.
Preset		acts as a direct select for a preset.
Palettes		acts as a direct select for a palette.
Macro		acts as a direct select for a macro.
Blank		can be assigned a target.
Tombstone		mirrors the channel indicators from the live/blind summary view.
Fader		assigns a virtual fader. If the virtual fader is assigned to an existing one, their settings will be the same.
Command Line		mirrors the command line. Can be assigned to mirror the command line for any user. Multiple command lines for different users can be used.
Text		places descriptive text on the sheet. The text can also be assigned a target.

Clock		adds a clock.
Response Analog IO		displays the status of a connected Response Analog IO gateway.
TimeCode		displays the status of a specified event list's time code.
sACN Input		displays the sACN input values.
Foundation Motor		Adds a Foundation Motor item to sync with an actual Foundation.
Line		draws a line. Examples of use could be as a pipe for fixtures or a divider between buttons.
Truss		places truss.
Shapes		draws shapes that can have a target assigned to them or could be used to represent set pieces.
Points		allows for free form creation of objects.

### ***Fixture Symbols***



From the second tab, fixture symbols can be placed on a magic sheet. The symbols can be tied to a channel number. Information about that channel can be displayed with the symbol, such as intensity, FCB data, and error indicators. See [MS Object Properties \(on page 414\)](#) for more information on the customizing options available.

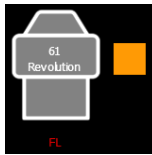

An example of a fixture showing the channel number, fixture type, intensity, and a color swatch.

## Importing Fixture Symbols

Additional fixture symbols can be imported. The symbol must be saved as a .svg image file, and needs to be tagged properly. These tags can be linked to the channel's color, intensity or both.

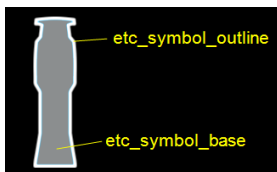

The outline section needs to be tagged as `etc_symbol_outline0`, `etc_symbol_outline`, and/or `etc_symbol_outline2`. The base section needs to be tagged as `etc_symbol_base0`, `etc_symbol_base`, and/or `etc_symbol_base2`. Tags can be layered, and they will render in the order listed below:

- `etc_symbol_base0` - uses fill color intensity link (not color)
- `etc_symbol_base` - uses fill color and intensity link
- `etc_symbol_base2` - uses fill color intensity link (not color)
- `etc_symbol_outline0` - uses outline intensity link (not color)
- `etc_symbol_outline` - uses outline color and intensity link
- `etc_symbol_outline2` - uses outline intensity link (not color)

Tags that only link to intensity will cause the base or outline to dim based on the channel's intensity.

The edits to the tags in the .svg file can be made in any text editor program, such as Notepad, or in a .SVG editor program, such as Inkscape.

See [Images \(below\)](#) for import steps.

## Images

Images from the third tab can be imported into magic sheets for two different purposes. They can be used as background images or as icons.

You can use a graphics image file as a background or icon. The following is a list of accepted image formats: .bmp, .gif, .ico, .jpg, .pbm, .pgm, .png, .ppm, .svg, .svgz, .tga, .tiff, .xbm, and .xpm. The maximum image size allowed is 1920 x 1920. Larger images will be scaled to this size.



## Importing Images

You will need to have the images on a USB drive to import them into the desk.

Once an image has been imported, it is saved with the show file.

To import an image:

1. Click on the import image icon. A separate window will open displaying any found USB drives.
2. Select the appropriate drive.
3. Navigate to the file you use to upload.
4. Click on the file and then press **{Ok}**. It will now appear in the images tab.

Click on an image to select it. To use as an icon, drag and drop the image onto the magic sheet. You will be able to resize it. See [Editing Objects on the Magic Sheet \(on page 417\)](#).

Background images need to be set in the background settings tab. You can also adjust the background settings there. See [Background Settings \(below\)](#).

## Deleting Unused Images

Unused images that have been previously imported can be deleted from the console by clicking on the **{Delete Unused}** button.

A message will appear letting you know that "This action will close and save all Magic Sheets open for edit, then delete all unused Magic Sheet images." Select **{Ok}** to delete images or **{Cancel}** to exit out of this option.

## Background Settings

In the fourth tab, you can adjust the settings for the background. Three options are available for background types; you can either use a solid color, a gradient of two colors, or a image.

## Display Behavior

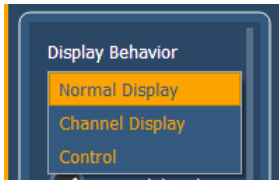

The following display behaviors are available:

- **Normal Display** - The display will behave the same as a Display Tab.
  - A locked tab will not be skipped.
  - A single click on the tab will draw focus to that tab.
- **Channel Display** - This mode uses the following rules:
  - When focus is drawn to the playback status display, a magic sheet channel display will be brought to the front.
  - Using **[Shift] & [Live]** cycles through the magic sheet channel displays as well as the Live channel displays.
  - Pressing **[Live]** or bringing a Live tab into focus will restore your last focused magic sheet channel display.
  - Magic sheet channel displays in the locked frame will not be skipped when using the **[Tab]** key to cycle through tabs.
- **Control** - The display will behave the same as a Controls Tab.
  - Locked tabs will be skipped.
  - A single click will not draw focus.
  - A double click will draw focus to the tab.

## Live and Blind Backgrounds

You can select live and blind backgrounds for magic sheets. These backgrounds can either use a solid color, gradient of two colors, or an image. One of these backgrounds will be used when editing a magic sheet. Select the **{Use While Editing}** button to use either the live or blind background.

### *Solid*

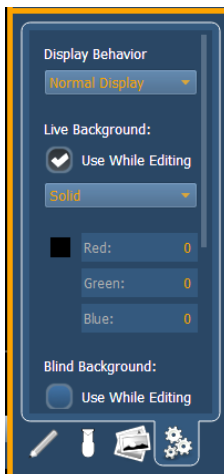



When solid is selected, you will have the chance to select a color for the magic sheet background. You can either click on the color square in the tab, which opens a color selection window, or you can manually enter the RGB values.

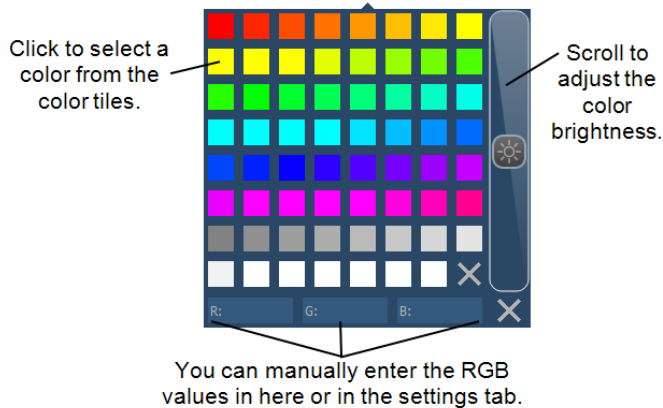

### ***Gradient***

When gradient is selected, you will have the chance to select a two color gradient for the magic sheet background. You can either click on the color squares in the tab, which open a color selection window, or you can manually enter the RGB values.

### ***Image***

With image selected, you can adjust the size, opacity, and invert the colors of the selected background image.

You can select or import an image directly from this tab by pressing the choose a background image icon, if no previous image had been chosen, or by pressing the thumbnail icon of the selected image to change it.



## ***Exporting and Importing Magic Sheets***

Magic Sheets can be exported and imported in .xml format. The export and import icons are located at the bottom of the background settings tab.

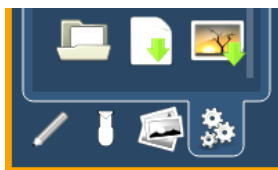

## MS Object Properties

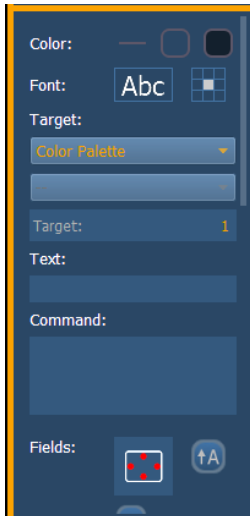

You can customize MS objects and fixture symbols in numerous ways found in the MS Object Properties area. With an object selected, you can modify its options.

The customizable options include:

- **Color** - the object's outline width, outline and fill colors can be adjusted here. The object's colors can either be set or tied to a channel's color or its intensity.

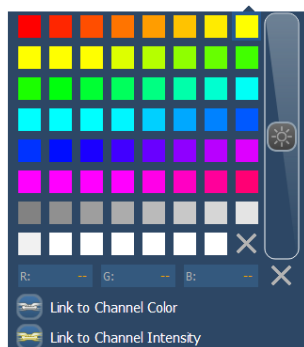

**Note:** *If any object's outline color is set to Link to Channel Intensity, the brightness of the outline color will be tied to the DMX level of the address. The higher that the DMX value is the brighter the outline color will be.*

---

- **Font** - the font used for a text object can be changed and adjusted as needed here. You can select font type, size, color, bold, italic, underline, and justification.
- **Target** - selects the target of the object. Most objects default to a target type, but that can be changed. The targets available are:
  - Address
  - Beam Palette
  - Channel
  - Channel (by Address)
  - Color Palette
  - Cue

- Cue - Active
- Cue - Pending
- Effect
- Fader
- Focus Palette
- Group
- Intensity Palette
- Macro
- Magic Sheet
- Pixel Map
- Preset
- Scene
- Snapshot
- Submaster
- User
- Console Button
- Command
- Zoom - when clicked, the view will zoom in to show all object within that object's group.
- Selection - when clicked, all other objects within that object's group will be selected.
- **Text** - changes the text for a text object.
- **Command** - assigns a command to be executed. The target type needs to command.
- **Fields** - up to six different fields of custom information can be displayed per objects. The justification of each field around the object can be adjusted. The text and color used for each field can also be adjusted. A scroller indicator bar can be added. Fields can display the following data:



- Target ID
- Fixture Type
- Target Name
- Label
- Text 1 through 10
- Text Gel
- Intensity
- Intensity Bar
- Color Swatch
- Summary
- Focus

- Color
- Beam
- Status
- Prev Move
- Next Move
- Channel
- Address
- Port/ Offset
- DMX
- DMX Bar

If multiple fields have the same justification, they will be stacked in field order.

The orientation of fields around the object can be adjusted by pressing the field orientation icon. You can also choose to keep text upright by pressing the icon to the right of the orientation icon.

There are three options for orientation:

- **Exterior Bounds** - fields will be exterior to the object and will remain at a position regardless of the rotation of the object.

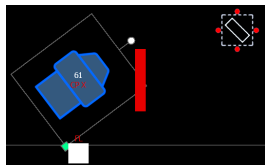

- **Interior** - fields will be in the interior of the object. This orientation is useful for desk buttons.



- **Exterior Shape** - fields will be exterior to the object and will move in relation to the object's rotation.

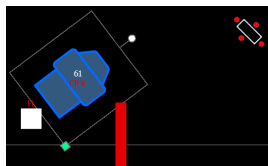

Position:	X:	480
	Y:	50
Size:	W:	80
	H:	60
Rotation:	Angle:	0
Items:		1

- **Position** - shows the position of the object on the magic sheet. Position can be manually entered here.
- **Size** - shows the size of the object. Size can be manually entered here.
- **Rotation** - shows the rotation of the object. Rotation can be manually entered here.
- **Items** - refers to the number of objects selected for editing. Multiple objects can be edited at the same time.

## Editing Objects on the Magic Sheet

In addition to using the editing tools, objects can be manipulated on the magic sheet using a touchscreen or a mouse. For selection methods for multiple objects, see [Navigating a Magic Sheet \(on page 401\)](#).

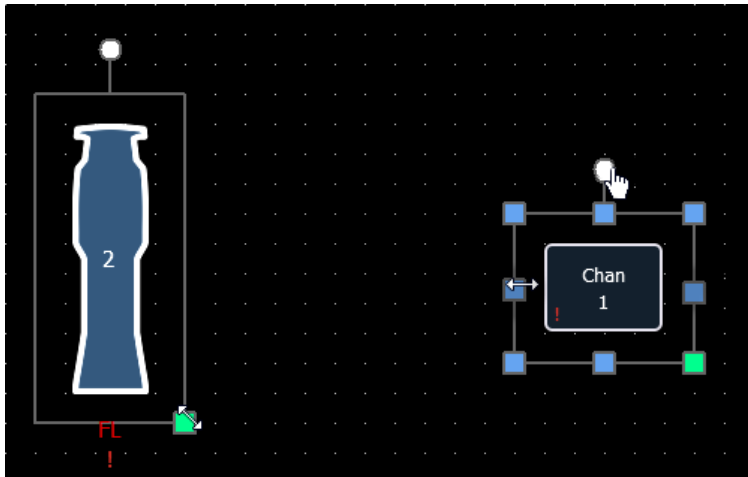

- The blue handles are used to resize objects without keeping the object's aspect ratio.
- The green handles are used to resize an object while preserving the aspect ratio.
- The white handles are used to rotate the object.

## Limited Expand Mode

Limited Expand Mode allows for a magic sheet to be viewed fullscreen. To enter into this mode, you can either select it from the magic sheet display tools ([Display Tools \(on page 400\)](#)) or you can use **[Shift] & [Displays]**. **[Shift] & [Displays]** is also used for exiting this mode.

While in this mode, the monitor with the magic sheet will not display a tab number, command line, or status bar. These will all be hidden. If there were other tabs open on that monitor, they will close when the magic sheet goes into limited expand mode. If tabs 1 or 2 are open, they will move to a different monitor.

The monitor will display a three dot heartbeat indicator in the top right hand corner. The indicator will move between three dots to show that your console is operating as expected.

The following indicator colors will be used for multi-console activity:

- **Yellow** - system is operating as expected.
- **Red** - master or backup has gone offline.
- **Green** - master or backup has reconnected.

Magic sheets are not editable in this mode, but the magic sheet browser is accessible. On a touchscreen, you can access the magic sheet browser by tapping with three fingers.

In the magic sheet display tools, there are two additional options that are available whenever you go into limited expand mode.

Those options include:

- **Disable Keyboard Input** - disables input from the facepanel and an external keyboard. Fader and macro buttons will still work.
- **Lock Fader Page** - locks the fader page to the currently displayed one.

## Examples of Magic Sheets

The following are examples of magic sheets created using the magic sheets feature. These examples use a variety of objects provided in the software along with user-generated images.

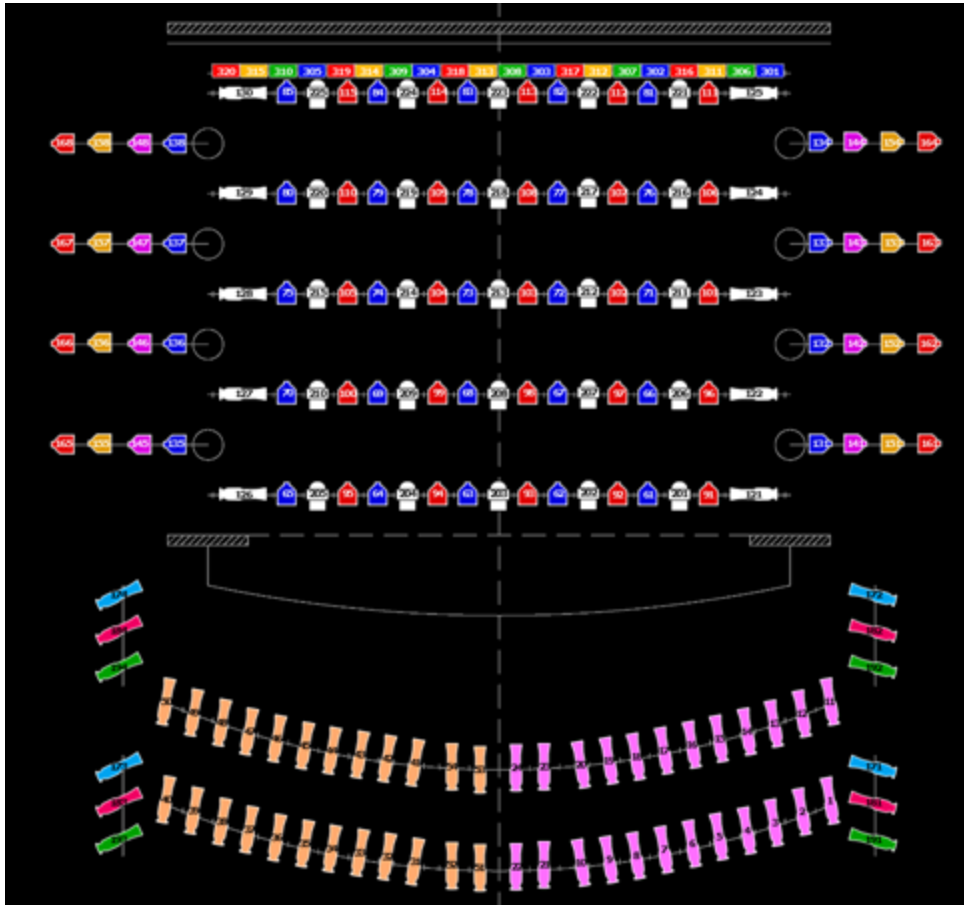

Group 10 Revolutions		Effect 904 Can Can	Stop Effect
Group 11 Mac 700's "O" truss		Effect 901 Circle	
Group 12 Mac 2K's Ground		Effect 908 Reverse Circle	
Group 13 Mac 2K Pros		Effect 902 Square	
Group 14 VL 3500 Spots		Effect 907 Reverse Sqr	
		Effect 905 Triangle	
		Effect 903 Figure 8	
		Rate @ 10	
		Rate @ 50	Size @ 50
		Rate @ 100	Size @ 100
		Rate @ 200	Size @ 200
		Rate @ 400	Size @ 400

Group 1 Specials 	Group 6 Center Breakups 	Group 9 LEDs 
Group 2 Area Lights 	Group 7 Outside Breakups 	
Group 3 Blue Sides 	Group 10 Revolutions 	Group 11 Mac 700 "O" Truss 
Group 4 Red Sides 	Group 12 Mac 2K Ground 	
Group 5 Amber Sides 	Group 13 Mac 2K Pro 	Group 14 VL3500 Spots 





# Chapter 26

## Virtual Media Server

---

About Virtual Media Server .....	422
Media Content .....	422
Exporting Media Content .....	423
Patching the Virtual Media Server and Layers .....	424
Creating a Pixel Map .....	424
Working with the Virtual Media Server .....	426
Effect Layers .....	432
Pixel Mapping in a Multi-Console System .....	434

## About Virtual Media Server

The virtual media server feature of Eos is comprised of two areas, the virtual media server and its virtual layers, and pixel maps. These areas are completely dependent on each other.

The virtual media server is a feature used to create layouts of fixtures, known as pixel maps, which then applies media content (images, movies, text, and procedurally generated effects) by way of virtual media layers to the pixel map.

A pixel map is a layout of fixtures onto a grid, which determines order of playback and how the data will be interpreted and outputted to create the desired image or effect. A pixel map creates relationships among the channels in an X-Y grid so that the channels and their parameters can be associated with pixels in an image.

A virtual media layer contains one piece of media content. A pixel map can contain up to 12 virtual media layers, which can be stacked on top of each other or used separately.

## Media Content

Images, movies, text, and html files can be applied to a pixel map. A stock library of media is provided when the Eos Family Pixel Mapping Installer is installed. Please see the Eos Family Pixel Mapping Installer v1.0.1 Release Note for installation instructions.

Additional media content can be installed. Supported media file formats are:

- Images - .png, .jpg, .gif, .tiff, and .svg
- Movies - any format that QuickTime® supports.(.3gp .3gpp .3gpp2 .3gp2 .3g2 .3p2 .flc .h264 .hdmov .m4a .m4b .m4p .moo .moov .mov .movie .mp4 .mpg4 .mpg4 .mqv .mv4 .pic .pict .qif .qt .qti .qtif .tvod .vid)
- Text - .txt
- HTML - .htm, .html

## Importing Media Content

There are three ways to import media. Those methods are:

- Import All Pixel Map Media - An automatic method for importing media.
- File Manager - A manual method for importing media.
- Import Show Pixel Map Media - An automatic method of importing all media needed for the current show file. Used by backup and clients. For more information on synchronizing media content, see [Synchronizing Media Archives \(on page 435\)](#).

File names for media content need to follow the naming convention of file number\_filename. For example, 002\_Volcano.mov is a file name that would be recognized. When importing by using the file manager, you need to number the files prior to importing. However using Import All Pixel Map Media allows you to specify the library and file numbers, and the console will autonumber the file names as needed during the import process.

## Using Import All Pixel Map Media

To import go to **Browser>File>Import> Pixel Map Media>All Pixel Map Media** and select the device with the media on it.



Options in this display include:

- **{Library (1-255)}** - selects the library to import media.
- **{File (0-255)}** - selects the file number.
- **{Reorder Libraries}** - specify whether or not the library on the source device will be renumbered. If the source device's library is not numbered, it will be assigned the specified library number.
- **{Reorder Files}** - specify whether or not the file(s) on the source device will be renumbered. If the source device's file(s) is not numbered, it will be assigned the specified file number.
- **{Overwrite}** - overwrite the existing media files.
- **{Start Import}** - begins the import process. A progress bar will appear to indicate the status of the import process. When finished, click **{Done}**.
- **{Cancel}** - stops the import, and exits the display.

## Importing with the File Manager

To import go to ECU>Settings>Maintenance>File Manager.



**Note:** Make sure your files follow the naming convention of file number\_filename. If the files do not, they will not be recognized as media files. You can always import using Import All Pixel Map Media instead.

Select the device with the media on it in one window and in the other window select the MediaArchive folder. Inside the MediaArchive folder, you will see numbered folders. Those folders correspond to libraries. You can copy or move files.

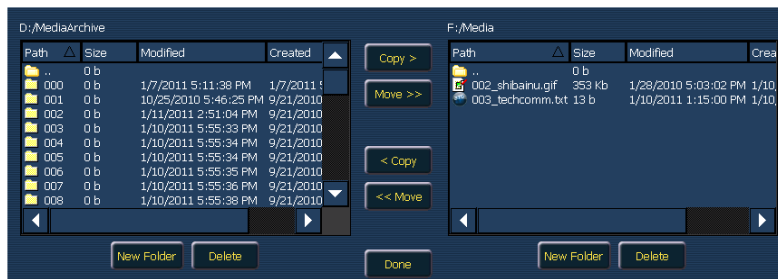

## Exporting Media Content

There are two ways to export media. Those methods are:

- Export Pixel Map Media - An automatic method for exporting media.
- File Manager - A manual method for exporting media.

## Using Export Pixel Map Media

This is an automatic method of exporting all the media used in the current show file. This includes any pixel map media stored in cues, presets, submasters, etc.

To export, go to **Browser>File>Export>Show Pixel Map Media**. Select the device you want to export the media content to.

There are only two options available in this display:

- **{Start Export}** - begins the export process. A progress bar will appear to indicate the status of the import process. When finished, click **{Done}**.
- **{Cancel}** - stops the export and exits the display.

## Using File Manager

Exporting with the file manager is very similar to importing with it. You select the files in the MediaArchive folder that you wish to export, and you can either copy or move them to your device.

## Patching the Virtual Media Server and Layers

To get started using this feature, you must first patch a channel as the Virtual Media Server and additional channels as layers.

You will need to be in the patch by channel display.

In the patch display, enter the channel number that will be your virtual media server. Press **{Type}** then **{Manufctr}** to display the fixture library. Select **{ETC}**, **{Virtual}**, and then **{Server\_Ver\_1.0}**.

Enter the channel numbers that will be your virtual media layers. Press **{Type}** then **{Manufctr}** to display the fixture library. Select **{ETC}**, **{Virtual}**, and then **{Layer\_Ver\_1.0}**.

For information about **{Virtual Effect Layer}**, see [Effect Layers \(on page 432\)](#).

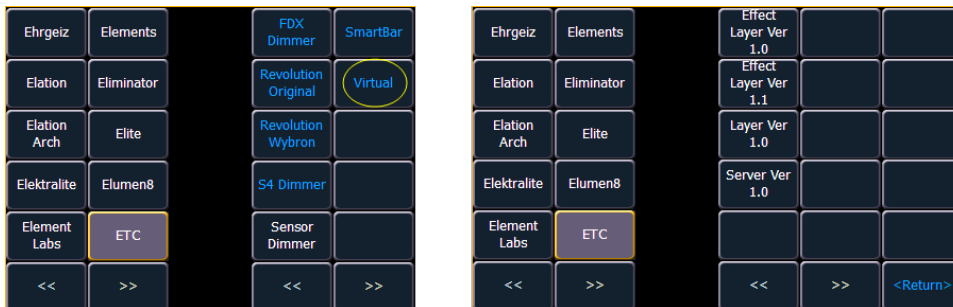

**Note:** No addresses need to be assigned in patch for the virtual media server and layers.

## Creating a Pixel Map

A pixel map is a layout of fixtures onto a grid, which determines order of playback and how the media content will be interpreted and outputted to create the desired image or effect.

A pixel map creates relationships among the fixtures in an X-Y grid so that the channels and their parameters can be associated with pixels in an image.

Limitations of pixel maps include:

- 40 pixel maps per show file
- 12 layers per pixel map
- 16,384 pixels per pixel map grid

Open up the Pixel Map display, **Displays>More SK>Pixel Maps**. The display can also be opened from the home screen, or by using **[Tab] [9]**.



**Note:** *Hovering your cursor above the pixel map will display the column and row location for the pixel.*



In the Pixel Map display, any numeric entry is assumed to be a Pixel Map. Each pixel map must have a unique number.

To create a pixel map, type in the number you want to assign to it and hit **[Enter]**.

The virtual media server and layer(s) need to be assigned to the pixel map. Using the softkeys, select **{Server Channel}** and the channel you patched as the Virtual Media Server.

Then select **{Layer Channels}** and the channels you patched as Virtual Media Layers.

In this display you can also label the pixel map, assign the interfaces it will use, and adjust the width and height.

Column and row guides can be created numerically in either the Pixel Map or in the Edit displays. The guides can aid in viewing a pixel map.

When that basic information has been assigned to the pixel map, press the **{Edit}** softkey to select the fixtures.

In the edit screen, you will be able to define the array and types of fixtures. To do this, you can select pixels from the map by using a touchscreen or by holding down the left button on a mouse and dragging across the pixels you wish to select.

Once the pixels have been selected, you need to select their fixture type and then assign the starting address or starting channel.

- When either **{Starting Channel}** or **{Starting Address}** is selected, both fields will be cleared.
- Address-based pixels can not overlap with channel-based pixels. This includes the entire DMX fixture footprint.

- If using **{Starting Channel}**, any overlapping channel-based pixels will be removed and any overlapping address-based fixtures will be unpatched.
- If using **{Starting Address}**, any overlapping address-based pixels will be removed and any overlapping channel-based fixtures will be unpatched.
- When the **[Data]** key is latched, the address for channel-based pixels will display.
- When **[Format]** is pressed, the address will toggle between port/offset and address number.

By default, the addresses will be organized in rows starting from the left to the right and top to bottom. The edit screen shows a representation of the current mapping. The pixels are color coded based on if they have been patched or not. A color coding guide is provided on the screen.



**Note:** Any pixel can have its size adjusted for better representation of the actual fixtures. This is done by selecting the pixel and then dragging the vertical and/or horizontal borders.



**Note:** A pixel map can be moved within the edit display by holding down the right mouse button. The map can be zoomed either by using a mouse wheel or by holding down **[Format]** and moving the level wheel.

Options available for changing the mapping:

- **{Horizontal Order}** - toggle state from left to right to right to left
- **{Vertical Order}** - toggle state from top to bottom to bottom to top
- **{Direction}** - toggle state from rows to columns
- Click the **{Apply}** button to see the changes made while still in the edit display.

In the edit display, the softkeys will repaint to the following mapping options:



**Note:** To see the changes made by using the softkey mapping options, you don't need to press **{Apply}**.

- **{Rotate 90}**
- **{Flip V}**
- **{Flip H}**
- **{Invert}**

The **{Flash}** button can be used to check the address output while still in the edit display. **{Flash}** works the same as it does in Live.

When editing is finished, press the **{Done}** softkey to exit the edit display.

## Working with the Virtual Media Server

Before you begin working with the Virtual Media Server, you will want to open the Pixel Map Preview display from the home screen or by using **[Tab] [1][0]**. For manipulating the pixel maps, you can use either the encoders or the ML Controls, which can be opened from the home screen, by using **[Tab] [5]**, or by using the quick access tools.



**Note:** For any output, the Server Channel must be set to a level along with any layers you are using.



**Note:** You can use Park and Address Check for Virtual Media Server outputs.

## Server Channel Controls

When working with the Server Channel, the following controls will be available:

- **{Intensity}**
- **{Pan}** and **{Tilt}** - used to adjust layers within the frame.
- **{Color}** - filters color for all layers.
- **{FoView}** - field of view, or perspective.
- **{Crossfade}** - used to adjust the priority when devices in the pixel map are also used as desk channels. -100 gives the pixel map priority, and +100 give the desk channel priority. At 0 (the default) the output is calculated HTP for intensity and LTP for NPs.

The Virtual Media Server crossfade parameter level will display in subscript beside the intensity.



- **{Blend}** - is a smoothing function for crossfades. It is a linear parameter that defaults to zero.
- **{Scale}** - adjusts Scale of all layers.
- **{Aspect Ratio}** - adjusts aspect ratio of all layers.
- **{XYZ Rotation Controls}** - rotation control for all layers

## Layer Channel Controls

When working with the Layer Channels, the following controls will be available:

- **{Intensity}**
- **{Pan}** and **{Tilt}** - used to adjust the image of the individual layer within the frame.
- **{Color}** - filters the color of the content. For example, if all the colors are set to full, the content will play all colors normally. However if blue is at 0, then only the red and green pixels of the content will play. The color and gel pickers can be used to select color filtering quickly.
- **{Negative On/Off}** - with negative on, the output is the negative of the content. With it off, the content plays back normally.
- **{Image Brightness}** - this varies from intensity. The following images illustrates the differences between image brightness and intensity.



**Note:** All Virtual Media Layers operate in 16-bit color mode.

---

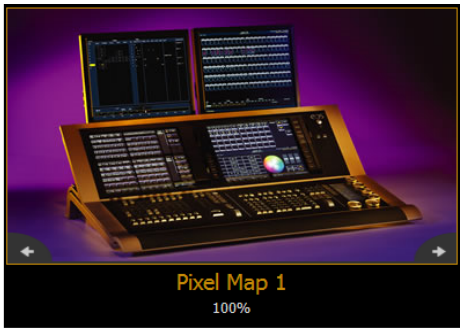

0% Brightness, Full Intensity

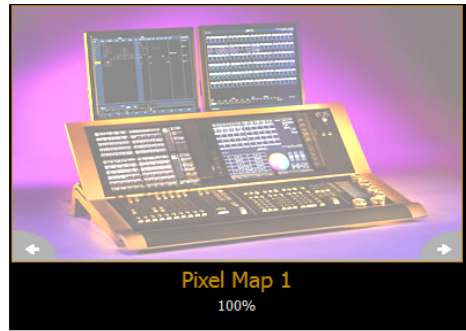

50% Brightness, Full Intensity

- {Playback Mode 1}:
- {Display Centered}
- {Display In Frame}
- {Display Out Frame}
- {Play Loop Forward}
- {Play Loop Reverse}
- {Play Once Forward}
- {Play Once Reverse}
- {Stop}
- {Playback Speed}
- {In Point} - determines where in the clip (frame number) you want to enter in.
- {Out Point} - determines where in the clip (frame number) you want to exit.
- {Mix Modes} - sets how the layers will interact. The following table shows the various mixer modes available. To illustrate the modes, the following layers were used:







Top Layer













Bottom Layer

Mode	Description	Result
{Over} (Default)	Top layer blended with bottom layer	



Mode	Description	Result
{In}	Top layer with opacity reduced by opacity of bottom layer	
{Out}	Top layer with opacity reduced by inverse opacity of bottom layer	
{Atop}	Top layer with opacity reduced by opacity of bottom layer and then blended with bottom layer	
{Add}	Top and bottom layers color and opacity added together	
{Subtract}	Top and bottom layers color and opacity subtracted from each other	

Mode	Description	Result
{Multiply}	Top and bottom layers color and opacity multiplied together	
{Screen}	Top and bottom layers colors inverted and then multiplied together	
{Overlay}	Does a multiply or screen effect based on the lightness or darkness of the bottom layer	
{Lighten}	Top layer's color merges with bottom layer's color, with the lighter color winning	
{Darken}	Top layer's color merges with the bottom layer's color, with the darker color winning	

Mode	Description	Result
{Dodge}	Bottom layer's color brightened to reflect top layer's color	
{Burn}	Bottom layer's color darkened to reflect the top layer's color	
{Hard Light}	Does a multiply or screen effect on the lightness or darkness of the top layer	
{Soft Light}	Darkens or lightens colors depending on the top layer	
{Xor}	Top layer with opacity reduced by inverse opacity of bottom layer, and then blended with the bottom layer with opacity reduced by the inverse opacity of the top layer	

- {Library} - selects the image library.
- {File} - selects the media file within the selected library.

- **{Mask On/Off}** - masks takes a lower layer and a higher layer, finds only the non-transparent pixels they have in common, and then displays the common pixels of the higher layer.
- **{FoView}** - perspective
- **{Scale}** - changes the scale of the content to either be larger or smaller than the standard content playback.
- **{Aspect Ratio}** - stretches or shrinks the content only along the X axis, making it wide or squished looking. Z Rotate can be used to modify the aspect ratio along the Y axis.
- **{XYZ Rotation Controls}** - rotation control for all layers.

## Effect Layers

The Virtual Media Server allows you to use procedurally generated content. This is content that is created algorithmically in real time, instead of rendering file based media.

In order to use procedurally generated content, you must patch the pixel map layer as a virtual effect layer instead of a virtual media layer. Setting up the pixel map is the same as for using virtual media layers. There are two versions of the effect layer, **{Effect Layer Ver 1.0}** and **{Effect Layer Ver 1.1}**.

## Types of Effects



There are three main effect types:

- **Two color gradients** - adjustable gradients with start and end colors
- **Rainbow gradients** - fixed gradient, full hue spectrum
- **Perlin noise** - good for animating random color effects, adjustable gradients

The effects are stored in file 1. File 1:0 is a home position of no effect. 1 through 3 are perlin noise effects, 4 is a perlin noise/ rainbow gradient, 5 through 9 are rainbow gradients, and 10 through 19 are two color gradients.

Effects have various options of additional control.

### ***Using Two Color Gradients***

For the effects that use two color gradients (two color and perlin noise), there are several options for control of the gradients. The two colors are known as the start and end colors. Those options include:

- **{Intensity}** and **{Intensity 2}** - specifies the opacity of the start and end colors respectively for Virtual Effect Layer 1.0. If you want to fade a two color effect using this layer, you will need to fade both **{Intensity}** and **{Intensity 2}**.

- **{Intensity 2}** and **{Intensity 3}**- specifies the opacity of the start and end colors respectively. **{Intensity}** is a master opacity control for the entire layer. This is for Virtual Effect Layer 1.1. If you want to fade a two color effect using this layer, you can just fade the **{Intensity}**.
- **{Red}**, **{Green}**, **{Blue}** or **{Hue}** and **{Saturation}** - specifies the start color. You can also use the Start Color picker.
- **{Red 2}**, **{Blue 2}**, and **{Green 2}** - specifies the end color. You can also use the End Color picker.
- **{In Point 1}** and **{Out Point 1}** - changes the distribution of the two colors in the gradient. In Point 1 moves the start color position closer to the end color. Out Point 1 moves the end color position closer to the start color.
- **{Playback Mode 1}** - basic animation, forward or reverse.
- **{Playback Speed 1}** - speed of animation.
- **{Layer Effect}** - adjusts the number of repeats in the gradient. Layer Effect has a range of -100% to 100%. At the home value of 0%, one full gradient is shown. Moving toward 0%, you will see less of the gradient and moving toward 100%, you will see up to four repetitions of the gradient.



**Note:** The button **{Layer Effect 2}** is for use with perlin noise effects.

## Using Rainbow Gradients

For Rainbow Gradients, the colors cannot be adjusted. But the number of repeats can be adjusted by using **{Layer Effect}**. **{Playback Mode 1}** and **{Playback Speed 1}** work in the same way as for two color gradients.

## Using Perlin Noise

For perlin noise effects, there are different options for control:

- **{Playback Mode 1}** - basic animation of noise, forward or reverse.
- **{Playback Speed 1}** - speed of animation.
- **{Layer Effect}** - adjusts the amount of noise. -100% equals very little noise, and 100% equals a lot of noise.
- **{Layer Effect 2}** - adjusts the horizontal scrolling speed. -100% equals a fast left scroll, 0% equals no scrolling, and 100% equals a fast right scroll.

## Effects Color Pickers

The effect layers have a two color pickers for selecting the start and end colors.

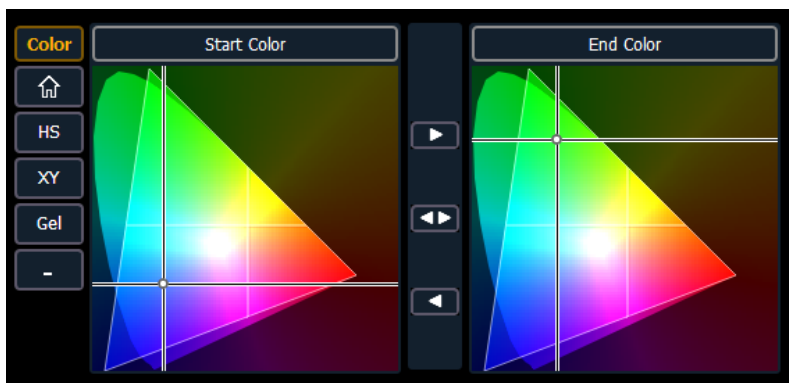

You can copy or swap a color between the two color pickers using the buttons located between them.

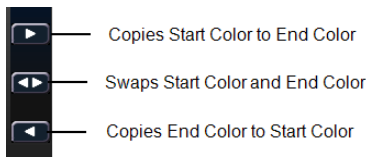

## Pixel Mapping in a Multi-Console System

When using file based media in a multi-console environment, the primary console should be used as the 'base' media archive.

Media can be imported to the primary, and the backup console and/or any other clients can then synchronize their own, local media archives with the primary. The backup must synchronize media with the primary in the event that the backup must take control as the master. For clients, synchronizing the media is optional but useful if you wish to see the media playing back in the Pixel Map Preview display.

### Steps for Configuring a Multi-Console System

Once the Eos Family Pixel Mapping Installer has been installed on all consoles, follow these steps to configure your multi-console system:

Setting up the Primary

1. On the primary console, exit to the Eos Configuration Utility (ECU).
2. Press the **{Settings}** button.
3. Press **{General}** if needed.
4. Make sure that the **{Share Media Archive}** box is checked. This will allow for sharing of the primary's media archive. Copy the path name, you will need it to setup the backup and/or client.



5. Setting up the Backup and Clients
6. On the backup or client, exit to the Eos Configuration Utility (ECU).
7. Press the **{Settings}** button.
8. Press **{Maintenance}**.

9. Press **{Network Drives}**.

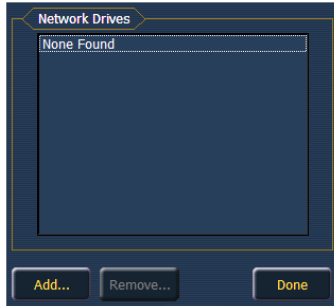

10. In the Network Drives display, click the **{Add}** button.
11. In the Add Network Drive display, choose a drive letter for **{Local Drive}**.

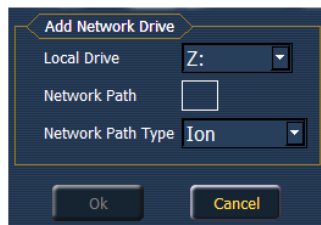

12. Enter in the **{Network Path}**. The path name is listed next to the primary's **{Share Media Archive}** checkbox.
13. Select the appropriate console type for the **{Network Path Type}**.

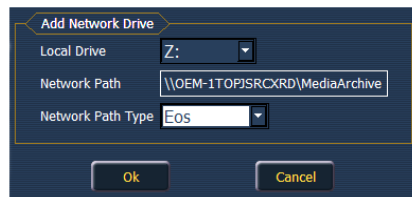

14. Click **{Ok}**. You will now be able to access the primary's media archive from the backup or client. This new drive will appear in the browser like a USB drive.
15. Click **{Done}** and launch the Eos application.

## Synchronizing Media Archives

To view media playback in the Pixel Map Preview display, you will need to first import the required media into your backup and/or client's local media archive. This is done from the browser. There are two options for importing media:

- Import Show Pixel Map Media - This import function should be used by the backups and clients. It is the easiest way to ensure that your console will have all of the media required by the current show file.
- Import All Pixel Map Media - This import function should be used by the primary to load the base media content and later to load media on the fly as required. This import function provides more complex options, like targeting which Library and File the media data will be imported into. See [Importing Media Content \(on page 422\)](#).

Steps for Synchronizing Show Pixel Map Media

1. On the backup or client, navigate to the browser.
2. Expand **File>Import>Import Pixel Map Media>Import Show Pixel Map Media**.

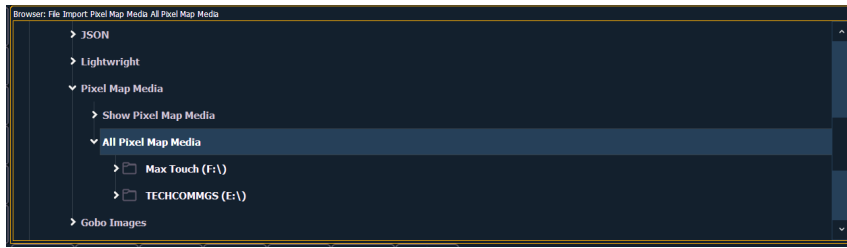

3. Select the appropriate network drive.
4. The Import Show Media display will open. Press the **{Start Import}** button.
5. A progress bar will appear to indicate the status of the import process. When finished, click **{Done}**. You will now be able to see the media playing in the Pixel Map Preview display on the backup and/or clients.



# Chapter 27

## Using Partitioned Control

---

About Partitioned Control .....	438
How to Use Partitions .....	438
Setting Up Partitioned Control .....	438
Partition List .....	438
Creating New Partitions .....	438
Deleting Partitions .....	439
Using Partitions .....	439
Partitions in Playback .....	439
Partitions on Cue Lists .....	439
Flexichannel in Partitioned Control .....	440

## About Partitioned Control

Partitioned control allows discrete control and programming of channels between multiple programmers.

When multiple programmers are working on an Eos Family system, partitioned control can be used to restrict a specific user's access to certain channels. This can help avoid overlapping control of channels by multiple programmers at once.

Channels can be included in more than one partition.

## How to Use Partitions

The primary use of partitioned control is to allow more than one programmer to work on a show file at the same time without the risk of one user storing data for another user's partitioned channels.

The most common example of this situation is when one user is programming moving lights while another user programs conventional fixtures. Partitioned control allows these users to divide the channels between them so they may work simultaneously. If one user stores data using record or record only, partition control will guarantee that only data for their partitioned channels will be stored. Data for channels not in their partition will be ignored when performing any store commands.

## Setting Up Partitioned Control

Partitioned Control is enabled or disabled in **Setup>System>Partitions** (see [System Settings \(on page 150\)](#).) Partition defaults to "Disabled". Enabling or disabling partitioned control is a system-wide setting.

## Partition List

To view the partition list display, press the **{Partitions}** button in **Setup>System**. This display lists all existing partitions. There are four pre-programmed partitions in Eos, they are:

- **Partition 0** - No channels and no fader control. This is the default for all users when partitioned control is enabled for the first time on a show. To gain control, you must select a different partition.
- **Partition 901** - All channels. Allows the user access to all channels.
- **Partition 902** - Single Parameter Channels. Allows the user access to only channels with a single parameter.
- **Partition 903** - Multiple Parameter Channels. Allows the user access to only channels with multiple parameters.

To select a partition in the list, enter it in the command line.

- **{Partition} [9][0][2] [Enter]**

If partitioned control is enabled, this will now be your assigned partition.

## Creating New Partitions

To create a new partition, press:

- **{Partition} [x] [Enter]** - where "x" is a number that does not yet exist in the partition list.

This will create a new partition, highlight it in the list, and (if partition is enabled) assign it as your partition.

To assign channels to that partition, enter them in the command line:

- **[1] [Thru] [9] [6] [Enter]**

You can also use **[+]**, **[-]**, and **[Group]** to further modify the channels in the partition. When adding/ subtracting channels to a partition, if you do not use **[+]** or **[-]** before channel numbers, the numbers will replace the channels in the partition, rather than adding to or subtracting from them. This overwriting does require a confirmation (if enabled in setup).

## Deleting Partitions

To delete any partition, simply type the syntax in the command line:

- **[Delete] {Partition} [5] [Enter] [Enter]** - deletes partition 5 from the list.

Preprogrammed partitions cannot be deleted.

## Using Partitions

Partitions are set on a user level. See [Assigning User ID \(on page 445\)](#) for more information.

When partitions are enabled and a partition is selected, you may only control and record data for the channels included in the partition, with the exception of parking and unparking channel parameters or playing back cues. If you try to control a channel that is not in your partition, Eos will post an advisory that this channel is outside of the partition, and you must confirm that you want to control that channel. You will not, however, be able to store information for that channel.

When you record a target (cue, preset, palette), only those channels that are partitioned to you are recorded. Other programmers' record actions to the same target can add to it (they do not replace it) unless channels are shared. When shared, the last value provided at the point of the record action will be stored.

## Partitions in Playback

In Eos, how faders are configured and what is loaded to those faders is shared across all control devices, with the exception of the master playback. As such, if the leftmost fader on page 1 is configured as submaster 1, all devices will display and control submaster 1 on that fader.

When content is played back from any device, it will be recalled in its entirety. If you wish to limit playback on cues, partitions can be assigned to cue lists. See [Partitions on Cue Lists \(below\)](#) for more information. Additionally, filters can be placed directly on the playbacks to restrict what is recalled on that fader. Filters are system wide.

Eos allows each user to assign different cue lists to their master fader pair. Using this feature, programmers can work within their partitions, using the master fader pair for their specific cue list, without affecting the cue list that is loaded to the master fader of another user.

Element 2 is limited to one cue list.

## Partitions on Cue Lists

A partition may be assigned to a cue list. If a partition has already been applied to a cue list, any channels not in the cue list's partition will not be included in cues when they stored or replayed.

Any data for a cue list that already existed before a partition is applied, will be maintained, including data for channels not included in the partition. If data existed before the partition was assigned, in blind, channels that are not in the partition will display without a channel graphic, any levels will be in gray, and a small superscript N will display with it.

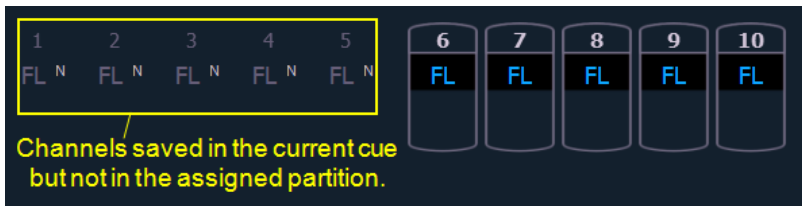

Assigned partitions will display at the top of the cue list index and in the PSD.

To assign a partition to a cue list:

- [Cue] [n] [/] {Partition} [n] [Enter]

To remove a partition from a cue list:

- [Cue] [n] [/] {Partition} [Enter]

## Flexichannel in Partitioned Control

When partitioning is enabled, a flexi mode, "Partitioned" is available as a softkey. When this is enabled, the flexi mode is limited to only those channels defined in the current partition. This mode may be further modified by use of the remaining flexi states. See [Using Flexichannel \(on page 59\)](#) and [Flexichannel Views in Patch \(on page 106\)](#) for more information.

# Chapter 28

## Multi-console and Synchronized Backup

---

Overview .....	442
Multi-console Setup .....	442
Synchronized Backup .....	446
Mirror Mode .....	448

## Overview

This chapter outlines the procedures required to use multiple Eos Family control devices simultaneously on a network. It outlines the setup, configuration, and behavior that is entailed in an Eos Family multi-console scenario.



**Note:** *Only Intel-based Macs can connect as a client.*

---

Multi-console functionality is also used to provide synchronized backup of your show while running multiple devices on the network.

### Definition of terms

Familiarize yourself with these terms prior to setting up a multi-console system.



**Note:** *Eos Ti, Eos, Gio, Gio @ 5, Ion Xe, Element 2, Ion, and Element consoles, RVIs, RPUs, ETCnomad Puck, or ETCnomad may all be considered active units on an Eos Family network. For the sake of brevity, the term Eos is used to represent any /all of these options in the following descriptions.*

---



**Note:** *Net3 RVIs can not be configured to be a primary or a backup.*

---

- **Primary** - When an Eos is configured as a primary, other Eos devices can connect and synchronize with it. If using a backup processor, the primary is the Eos that will be backed up. By default, all Eos Family consoles will start up as a primary.
- **Backup** - The Eos capable of taking control of the system if the primary fails. You may input data and run your show from a backup. There can only be one backup in an Eos network and you must specify which primary it is backing up.
- **Client** - Any online Eos that is not the primary or backup is a client. Client data is sent and received over the network, and clients will synchronize with a designated primary.
- **Offline** - Any Eos controller that is disconnected from the Eos network. Changes to show data performed on an offline Eos will not affect the rest of the Eos network or the lighting system.
- **Master** - The Eos that is currently sending control data to the lighting system is the master. In most circumstances this is also the primary. Should a primary fail and a backup takes control, then the backup will be acting as the master.
- **Tracking** - Any device that is synchronized with a master is tracking. Once a backup takes control it becomes a master and is no longer tracking.
- **User** - A user is an Eos defined by a user ID. If it has a unique user ID, the Eos will operate separate from other Eos devices on the network, but still track show data. If it shares a user ID, Eos will synchronize with like IDs. See [About User ID \(on page 444\)](#)
- **System** - One primary Eos, one backup Eos, and (if available) multiple clients synchronized together.
- **Mirror Mode** - A mode for mirroring the displays of another device. See [Mirror Mode \(on page 448\)](#)

## Multi-console Setup

When using multiple Eos devices on the network, you should adjust some of the settings to ensure optimal functionality.

Additional requirements for multi-console setup include:

- Software versions must match exactly between all devices.
- All devices have to use the same fixture library. See [Update Profile \(on page 133\)](#).
- The language settings in the ECU must match. See [Language \(on page 454\)](#)
- The keyboard language setting in the ECU must match. See [Keyboard \(on page 454\)](#)



**Note:** *It is recommended that you perform the following setting changes **before** connecting your device(s) to the network. After the changes are complete, connect to the network and reboot the device.*

---

## Designate Primary

By default, all Eos devices will boot as a primary. When using multiple Eos devices on the network, only one should be designated as a primary. Other Eos devices should be configured as the backup (only one per system) or clients. There can be a maximum of 12 Eos devices connected to a master.

To change this setting, you must exit the Eos software (**Browser>Exit**) and then designate the Eos device as primary, backup, or client in the ECU Welcome Screen (see [Welcome Screen \(on page 452\)](#)).

## DHCP Server

DHCP server supplies IP addresses to network devices. Only one Eos device (typically the Primary) on the network is necessary to do this properly. Therefore you should disable the DHCP server on all Eos devices except for the intended primary.

To disable the DHCP server on your Eos device, go to **ECU>Settings>Network>DHCP Service**. See [Local Area Connection \(on page 459\)](#) for more information.

## Change Device Name

To easily identify your Eos on the network, change the device name to be representative of the device (such as "Booth Primary" or "Tech Backup"). This is done in **ECU>Settings>General**. See [General Settings \(on page 453\)](#) for more information.

## Backup Auto Switch

Switches to the backup automatically if the primary should go offline. This is enabled in **ECU>Settings>Network>Output Protocols**. See [Backup Automatically Takes Control \(on page 464\)](#) for more information.

## Backup at Higher Priority

This enables the backup device in a multi-console system to take over at one priority higher than the master if the master goes offline. This is enabled in **ECU>Settings>Network>Output Protocols**. See [Backup Takes Over At Higher Priority \(on page 464\)](#) for more information.

## Network Type

This setting adjusts the timeout period before a backup device will take control from the master. This is done in **ECU>Settings>Network>Interface Protocols**. See [Network Type \(on page 464\)](#) for more information.

- **Standard** - After five seconds of no response from the master, the backup will assume the master has disconnected and will then take control.
- **Engineered** - After 1.6 seconds of no response from the master, the backup will assume the master has disconnected and will then take control.

## Change IP Address

Each Eos device on the network should be given a unique IP address. If running multiple devices of the same type (for example - two consoles, or two RPU's), you must alter the default static IP addresses to ensure proper functionality. For a list of the default IP addresses for Eos devices, see [IP Address \(on page 460\)](#)

Changing the static IP address is done through the ECU (see [Network Settings \(on page 459\)](#)). Manually change the IP address of any non-master Eos device by clicking in the IP Address field and entering the new number from the keyboard. When done, press **[Enter]**.



**Note:** *It is recommended that you alter the very last digit of the static IP address by an increment of one for each additional Eos device on the network. Therefore, if the master ends in "101", change the backup to end in "102", a client to end in "103" and so on.*

---

## Output in Client Mode

Consoles in client or backup mode by default will not output on their local DMX ports. This option is found in **Setup>System>Output>Local DMX Options**. Click on **{Output in Client mode}** to enable the ability to output.

## Multiple Users

Eos can be set to act as a separate user from other consoles in the system, or it can be set to act as the same user as another console. This is done by changing the user ID.

Element 2 can be set to act as a separate user from other Element 2 consoles, RVIs, ETCnomad, and ETCnomad Pucks in the system, or it can be set to act as the same user as another Element 2, RVI, ETCnomad, or ETCnomad Puck. This is done by changing the user ID.

## About User ID

When multiple users are on the Eos Family network, they can all act as one combined user, as all separate users, or any of the varying degrees between.

Any Eos, Eos Ti, Gio, Gio @ 5, Ion Xe, and Ion console, RPU, RVI, ETCnomad, and ETCnomad Puck can be a separate user on the Eos Family network. Certain devices work well as independent users while others are intended to share a user ID with another device. For example, consoles and RPU's are likely candidates for working with a unique user ID while RVIs and client PCs can be useful sharing an ID with another device to track programming information from a second location.



**Note:** *Element 2 can be set to act as a separate user from other Element 2 consoles, RVIs, ETCnomad, and ETCnomad Pucks in the system, or it can be set to act as the same user as another Element 2, RVI, ETCnomad, or ETCnomad Puck.*

---

Set in the Setup (see [Users \(on page 158\)](#)), User ID is an Eos-specific identifier that can be set uniquely for each Eos device or can be shared between multiple devices allowing for certain data to be shared between consoles. The user ID can be set anywhere from 1 to 99.

The decision to share a user ID is based on the desire to share a common work environment and command line. It is often common for a designer to be the same user as a programmer so his displays and operating modes follow a programmer, and his command line mimics the programmer's. Alternatively, mirror mode of a user can be called. It is also possible to set the designer up as a completely separate user, adding a command line object to a magic sheet to allow a view into programming activities.



Devices sharing User IDs will share certain data, while those with different IDs will not. Below are the differences in multi-console data depending on User ID.

### **Data shared between Eos Family devices with the same User ID**

- command line
- null channels in live
- selected channels
- filters
- selected cue
- live/ blind mode
- Setup>User

### **Data specific to the Eos Family device, regardless of User ID**

- current fader page
- current encoder page
- focus on displays without command line
- display configuration (layout, format, visible parameters, flexichannel)
- paging without changing selected target or channels

### **Data identical between all Eos Family devices, regardless of User ID**

- all stage levels and edits
- all data stored in the show file
- playback, fader and grandmaster contents and progress

The default User ID for any Eos Family device is 1. You may change this based on your preference to allow/ restrict the functionality described above.

**Note:** After you have completed the setting changes described above, connect your Eos device to the network and reboot the device.

## **Assigning User ID**

User ID can be defined in **Setup>System>Users**, see [Users \(on page 158\)](#) for more information.

To quickly change the User ID, you can click on the User ID displayed above the CIA. A pop-up window will open with the available User ID options.

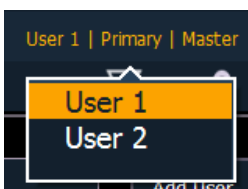

When multiple programmers are working on the system, partitioned control can be used to restrict a specific user's access to certain channels. This can help avoid overlapping control of channels by multiple programmers at once.

For more information on partitioned control, see [Using Partitions \(on page 439\)](#)

## **About Multi-console Backup**

Within an Eos system, you have the added bonus of show data backup. The backup on the system will receive all show data updates and stage levels so that, in the event of a primary failure, the backup will be capable of taking control of the system without a loss of show data or

live output. Saving occurs across the whole network.

## Synchronized Backup

Once you have changed settings to facilitate a multi-console system on the network, you may activate synchronized backup to ensure show data security.

Eos synchronized backup is designed so that during normal operation the primary device controls the lighting system, and any device configured as backup or client synchronize with the primary. The following activities will synchronize between consoles when operating in a backup system:

- Playback
- Record operations
- Manually set data
- Show file and data

## Setting up Synchronized Backup

Before backup is possible, you must have at least two Eos devices (Consoles or RPU's only) connected to the network. One must be assigned as primary and one as a backup.

To assign a backup to a primary:

1. Exit the Eos environment (**Browser> Exit Eos**) on the console you wish to act as the backup. This will send you to the ECU welcome screen.
2. Touch or click on the **{Backup}** button in the welcome screen. The console will then startup the Eos software, this time in backup mode. Eos will try to connect to a master console. The CIA will say "Waiting for Master. One moment please...".
3. If the backup doesn't connect after a few moments, press the **{Troubleshoot}** touchbutton in the CIA. This will open the network configure screen in the CIA.



**Note:** If this is the first time that a backup is connecting to this master, you will need to press **{Troubleshoot}** and select the master.



4. Select a master console from the list on the right. If no masters are available in the list, a master console is not connected to the network.
5. Press **{Change Master}**. The backup Eos will synchronize with the master.

In the CIA of each device, you will see its current status.

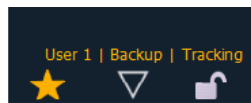
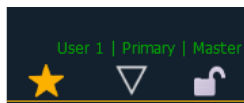

If the primary goes offline for any reason, the backup will automatically takeover as the master if backup auto switch has been enabled, see [Backup Automatically Takes Control \(on page 464\)](#). Whenever master control changes between the primary and the backup, there will be a dialog window that will be displayed that must be dismissed by the user.

When master control moves between the primary and backup devices, any clients in the system will automatically connect to the current master. Clients will also display a message, but the message will be dismissed after a short period of time. The device status above the CIA will also change.



**Note:** A backup may take up to 5 seconds to determine that connection with the master has been lost. This timing can be adjusted based on network type selected in the ECU. See [Network Type \(on page 443\)](#) for more information.



If you enter the **Network>Configure** screen, it will have changed to the following.

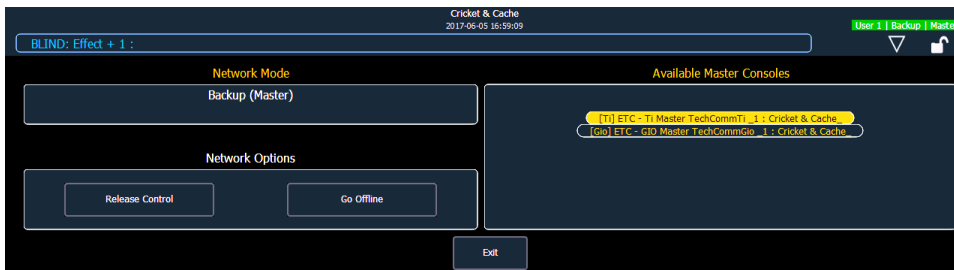

Your backup is now acting as the master and is controlling the lighting system.



**Note:** If the primary comes back online, it will **not** retake control of the lighting system. The primary will wait until it is re-designated as the master and the backup is reassigned to it. You can force the backup to release control back to the primary by going to **Browser>Network>Configuration** and pressing the **{Release Control}** button. You can also force the primary to take control away from a backup by going to **Browser>Network>Configuration** and pressing the **{Take Control}** button.

## Backup Scenarios

### Console and console

Two consoles can be used to provide backup. Either can be configured as the primary or the backup. If the master console fails, the second console will take control with full show data intact.

This is a useful scenario for touring multi-user applications.

### RPU and console

One RPU and one console can be used as a backup option. In this configuration, it is recommended that you set the RPU as the primary and the console as the backup. In this scenario, should the RPU go offline, you will still have the full functionality of the console user-interface at your disposal.

### RPU and RPU

Two RPUs may serve as primary and backup also. A backup system of this type can support many client consoles at once, which you may turn on and off as needed without the need to reset to a different master each time.

This application is ideal for permanent installations requiring synchronized backup.

## Remote Software Installation

Within a multi-console system, you can remotely install software to all devices.



**Note:** All devices must be upgraded to version 1.9 before remote software installation is available.

---

In the ECU, go to **Setting> General> Automatically Update Software** to enable. Once enabled, the devices can be remotely updated with the next version of software. Devices will receive the software update from the Primary. When you install software on the Primary, the software will first be copied to its hard drive.

With the devices synchronized with the Primary, install the new version of software onto the Primary. All devices will lose their connection with the Primary at that time. When the Primary comes back online after installing the software, all the connected devices will be forced to update their software before they can reconnect with the Primary.

## Remote Power On/Off

In a multi-console system, it is possible to power on and off devices remotely. Remote Power On and Remote Power Off must be enabled on each device before it can receive the power on and off commands. In the ECU go to **Settings> Network> Enable Remote Power Off** and **Enable Remote Power On**. The default setting for both is "Disabled".



**Note:** Original Eos consoles cannot be remotely powered on.

---

The Remote Power commands are sent from the browser. The command for Power On is sent from **Browser> Network> Power On MultiConsole System**, and the command for Power Off is from **Browser> Network> Power Off MultiConsole System**.



**Note:** Only devices that synchronize with the Primary will be available for Remote Power On and Off.

---

## Mirror Mode

Mirror Mode is used to mirror the displays of another device. When a device is in mirror mode, the only action allowed from that device is paging via the page keys and shut down/start up. When a device in mirror mode pages, it also pages the host.

Mirror mode is intended primarily to allow a designer or assistant to see the exact same displays as a programmer on the system. It can be used on any device on the network, including the primary processor. Any device being mirrored is referred to as the Host.

There is no limit to the number of mirrored devices a host can have. But a console currently in mirror mode cannot be mirrored.

A device that is currently in mirror mode can select which user number it is mirroring by using the alphanumeric keyboard shortcut ALT +F1 + # (# being the user number). ALT + F2 can be used to leave mirror mode.



**Note:** If a device is not currently in mirror mode, pressing M on an alphanumeric keyboard will post Macro to the command line.

---

## Using Mirror Mode on a Client without a Dongle

A client without a dongle can connect to the network. When this is done, the client can only operate in mirror mode, and it will always connect to the primary processor. No other options will be available.

### Configuring Mirror Mode

Configuring a device to connect in Mirror mode is done from the Displays menu in the Browser. When [Displays] is pressed, a {Mirror} softkey will be displayed. Pressing {Mirror} will open up a list of potential hosts in the CIA.

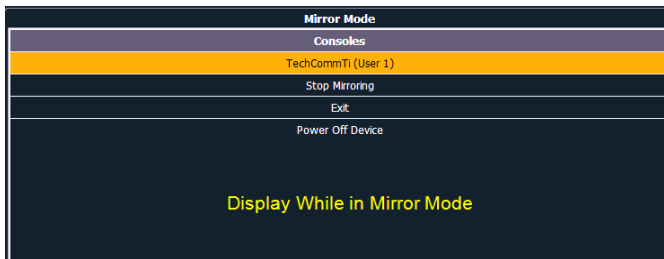
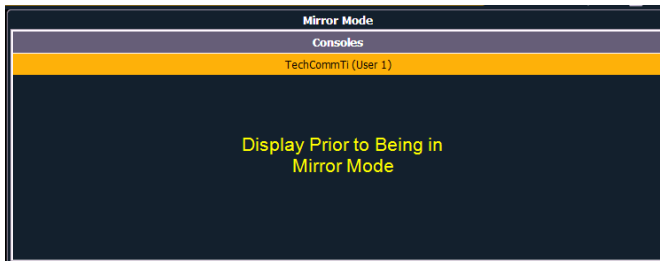

The mirror display can be navigated using the arrow keys or a mouse. When the required host is highlighted, press [Enter] or double click with a mouse to confirm the selection. This display can also be opened with the keyboard shortcut of ALT + F1.



**Note:** While in Mirror mode, the display will also have options for exiting and powering off the device.

### Mirror Mode Displays

When a device is placed in mirror mode, monitor 1 on the mirroring device matches external monitor 1 on the host, and monitor 2 matches external monitor 2 on the host. A client will mirror as many monitors as it has available.

All formats used on the host device are shown on the mirroring device including flexichannel states, column widths, chosen parameters, and pages.



**Note:** Desk settings are not mirrored.

The CIA will open on monitor 1. The CIA on the device in mirror mode can be locked open or closed. When left unlocked, the CIA will expand and close as normal. Not all CIA displays shown on the device in mirror mode. The following CIA displays are synchronized:

- About
- Effects
- Effects Status
- Color Picker
- Curves
- Undo

The CIA can be completely hidden when locked by pressing the **[Displays]** key. Pressing **[Displays]** again will display and unlock the CIA.

## Exiting Mirror Mode

Exiting mirror mode can be done by selecting **{Stop Mirroring}** in the mirror display or using the keyboard shortcut ALT + F2. When exiting mirror mode, the device will return to its normal, working state.



**Note:** *Clients without a dongle cannot exit mirror mode.*

---

## Shutdown/Start Up in Mirror Mode

When a device is shut down in mirror mode, it will restart in mirror mode mirroring the same host as before. If the host has changed settings, mirror mode will need to be reselected on startup.

## Macros

Macros can be created to configure a device for mirror mode and to exit the mode.

The face panel button configuration in the ECU allows the face panel buttons on Eos Ti, Gio, Gio @5, RPU, and RVI to be populated with these macros.



**Note:** *An alphanumeric keyboard will be needed to create this macro.*

---

To create a macro to place a device in mirror mode:

1. Set the User ID of all devices to match the Primary.
2. Press ALT + F1 to open the mirror mode display.
3. Highlight the device to mirror.
4. Press **[Learn] [x] [Enter]** to record the macro.

To create a macro to exit mirror mode:

1. With the console in mirror mode, press **[Learn] [x] [Enter]**
2. Press ALT + F2.
3. Press **[Learn]** to finish recording the macro.

Once the macros are created, you should save the show and set all User IDs back.

# Chapter 29

## Eos Configuration Utility

---

Overview .....	452
Eos Configuration Utility Reference .....	452
General Settings .....	453
Network Settings .....	459
Maintenance .....	467
Buttons .....	472
RFR .....	472

## Overview

This section covers the Eos Configuration Utility (ECU) and its use. This is a component of the Eos Lighting Control System and is used for both system configuration and performing basic level test functions. This section illustrates how to use the utility, but does not specify what changes to make as these are based on your preferences and can be changed to suit your control needs.

## Eos Configuration Utility Reference

You can force the desk to boot into the utility instead of the main desk application. During the boot process, a countdown timer will appear. You will have 5 seconds to click the timer or to hold down "e", "o" and "s" at the same time on the connected alphanumeric keyboard.

Otherwise, you can enter the ECU from the Eos application by choosing **Browser>Exit**.

If you want the desk to always boot into the utility, make sure **{Open in Shell E.C.U}** is checked. See [Open in Shell E.C.U \(on page 455\)](#).

## Welcome Screen

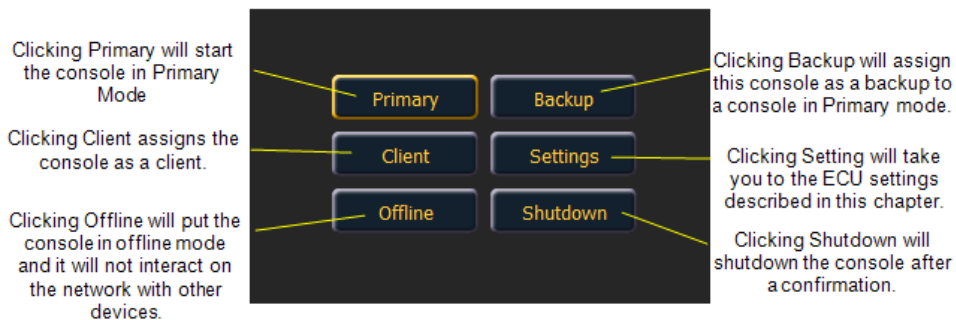

This is the starting screen of the utility. From here you can choose to boot the desk in one of several different modes, change various settings, or shutdown the desk.

## Primary

This is the mode for using a single desk in non-networked or networked applications. On a system with multiple desks, the primary is the desk that client and backup desks synchronize with, making it the source of all information a client or backup desk sees on the network.

Primary mode can be run on Eos Ti, Eos, Gio, Gio @ 5, Ion, Ion Xe, Element 2, Element, ETCnomad Puck, ETCnomad with dongle, and RPUs (Remote Processor Unit).

## Backup

Backup mode requires a primary device be online to synchronize. Once this is done, a backup desk intakes all show data for use in the event that it needs to assume control of the lighting system.

The main difference between backup and client modes is what happens in the event of primary processor failure. If the primary fails, a backup will ask if you want it to take control as the master of the system or if you want to troubleshoot the problem. You can set the backup to automatically take control. ([Backup Automatically Takes Control \(on page 464\)](#)) When the primary remains in control, the backup will behave as a client would.



Backup mode can be run on Eos Ti, Eos, Gio, Gio @ 5, Ion, Ion Xe, Element 2, Element, ETCnomad Puck, and RPU. For more information on backup systems, see [Multi-console and Synchronized Backup \(on page 441\)](#)

## Client

A device set to client mode can act as a remote controller or remote video station for a system. A client device cannot output to the lighting system. Only a primary or backup processor can do this.

User ID determines some interaction between the client and other devices. If the client and the primary desk have the same User ID, they will act as one. If they have different User IDs, they will have separate command lines. See [About User ID \(on page 444\)](#)

Client mode can be run on Eos Ti, Eos, Gio, Gio @ 5, Ion, Ion Xe, Element 2, Element, ETCnomad Puck, and ETCnomad with a dongle. Without a dongle, a client can connect in mirror mode. See [Mirror Mode \(on page 448\)](#)

Consoles in client or backup mode by default will not output on their local DMX ports. This option is found at ECU>Settings>Local I/O. Click on **{Output in Client Mode}** to enable the ability to output.



**CAUTION:** ETC does not recommend the use of wireless for show critical functions.

---

## Offline

Offline mode puts the software in a state where there is no network activity, no control, no connections with other consoles or any other network devices.

This mode is primarily intended for offline editing of a show file.

Offline mode can be run on Eos Ti, Eos, Gio, Gio @ 5, Ion, Ion Xe, Element 2, Element, ETCnomad Puck, and ETCnomad.

Offline w/ viz mode is available when running ETCnomad software without a dongle. This mode is only intended to be used with visualizer software, and does not output DMX.

## General Settings

The following options are available in this display :

- [Device Name \(on the next page\)](#)
- [24 Hour Format Clock \(on the next page\)](#)
- [Time \(on the next page\)](#)
- [Date \(on the next page\)](#)
- [Time Zone \(on the next page\)](#)
- [Language \(on the next page\)](#)
- [Keyboard \(on the next page\)](#)
- [Use Shift As Eos Shift \(on page 455\)](#)
- [Open in Shell E.C.U \(on page 455\)](#)
- [Automatically Update Software \(on page 455\)](#)
- [Fullscreen Offline Editor \(on page 455\)](#) (ETCnomad only)
- [High DPI Display Scaling \(on page 455\)](#)
- [Show Archive Path \(on page 456\)](#)
- [Media Archive Path \(on page 456\)](#)
- [Share Show Archive \(on page 456\)](#)

- [Share Media Archive \(on page 456\)](#)
- [Latitude \(on page 456\)](#)
- [Longitude \(on page 456\)](#)
- [Calibrate Elo Touchscreens \(on page 456\)](#)
- [Calibrate ETC Touchscreens \(on page 457\)](#)
- [Monitor Arrangement \(on page 457\)](#)
- [Software Update \(on page 458\)](#)

## Device Name

This specifies the name the desk will use to identify itself on the network to other devices. Examples might be Booth Desk and Tech Table.

## 24 Hour Format Clock

The time is displayed in a 24-hour format as HH : MM : SS. By default this is disabled. Click to enable.

## Time

The time the desk is using. This can be changed manually (direct data-entry) or via SNTP (Simple Network Time Protocol) time service. Please see [Network Settings \(on page 459\)](#) for more information.

The time defaults to 12 hour format. To use 24 hour format, make sure **{24 Hour Clock}** is checked. See [24 Hour Format Clock \(above\)](#).

## Date

The date the desk is using. This can be changed manually (direct data-entry) or via SNTP (Simple Network Time Protocol) time service. Please see [Time Service \(SNTP\) \(on page 467\)](#) for more information.

The date is displayed as DD / MM / YYYY.

## Time Zone

The time zone the desk is using. This is an offset from Greenwich Mean Time (GMT). Each setting in the pull-down list displays the offset, the name of the time zone and a couple of cities in that time zone.

## Language

Allows you to select the display language of Eos. Choices include English, Catalan, Bulgarian, German, Spanish, French, Italian, Slovak, Turkish, Japanese, Korean, Russian, Chinese - simplified, and Chinese - traditional.

## Keyboard

Allows you to select the language for the alphanumeric keyboard within Eos. A wide variety of keyboards are supported.

The keyboard can also be changed in the application when the virtual keyboard is open. Click on the flag icon to see a language drop-down menu.

Press **{Sym}** to switch the keyboard from alphanumeric to symbols. When in symbol mode, press **{Abc}** to return to the alphanumeric keyboard.



## Use Shift As Eos Shift

Allows the SHIFT key on an alphanumeric keyboard to be used as the console's [Shift] key. If not selected, the Z key on an alphanumeric keyboard will function as the [Shift] key.

## Open in Shell E.C.U

When this is checked, the desk will boot into the Configuration Utility every time instead of booting directly into the main application.

## Automatically Update Software

When this is checked, the desk will receive software updates from the primary if used in a multi-console system.

## Fullscreen Offline Editor

For ETCnomad, there is an additional ECU setting to allow Fullscreen Offline Editor mode. Instead of separate windows, the displays will be fullscreen.



With this mode disabled, you can choose up to six windows to display. Fullscreen Offline Editor mode is enabled by default.

## High DPI Display Scaling

When using a High DPI 4k display, you can set the display scaling to make small text more legible.

The following options are available:

- **Auto** - the software will be scaled up to appear larger on high DPI displays - depends on monitor and Windows support for auto-detecting such displays. This is the default setting.
- **2x** - if Auto fails to automatically scale up the software on high DPI displays, select this option to force everything to be larger.
- **Disabled** - keeps the software at its native sizes and scaling, which will appear to be very small on High DPI displays

## Show Archive Path

This is the default location to save show files. The full path must be typed in and specified in a legal Windows format. The default location is a folder on the D: drive.

If you decide to change this setting, it is recommended that you keep this location on the D: drive.

## Media Archive Path

This is the default location to save media files. The full path must be typed in and specified in a legal Windows format. The default location is a folder on the D: drive.

If you decide to change this setting, it is recommended that you keep this location on the D: drive.

## Share Show Archive

Checking this box will enable you to share the show archive folder on the desk with another desk or computer via Windows File Sharing (SMB).

## Share Media Archive

Checking this box will enable you to share the media archive folder on the desk with another desk via Windows File Sharing (SMB).

## Latitude

Allows you to select the latitude the desk is using.

## Longitude

Allows you to select the longitude the desk is using.

## Calibrate Touchscreens

This will launch a screen calibration utility to guide you through the process of re-calibrating the touchscreens. This should be used if the pointer is consistently offset from where you are touching the screens. You can choose to calibrate the on-board left, right, and small touchscreens.

Each screen is calibrated independently.

## Calibrate Elo Touchscreens



**Note:** Before you calibrate your external touchscreens, you may need to first use the External Monitor Arrangement display. See [Monitor Arrangement \(on the facing page\)](#)

---

Allows you to calibrate an Elo touchscreen. With the touchscreen connected, press the **{Calibrate Elo External Touchscreen}**.

The first display will have you touch some targets, and the second will have you touch various parts of the display to make sure the cursor follows your finger. If that works fine, press the green checkbox. If you need to return to the previous display, press the blue arrow button.

## Calibrate ETC Touchscreens



**Note:** Before you calibrate your external touchscreens, you may need to first use the External Monitor Arrangement display. See [Monitor Arrangement \(below\)](#)

Allows you to calibrate an ETC touchscreen. With the touchscreen connected, press the **{Calibrate ETC External Touchscreen}**.

The first display will have you touch various parts of the display to make sure the cursor follows your finger and the second will have you touch some targets.

## Monitor Arrangement

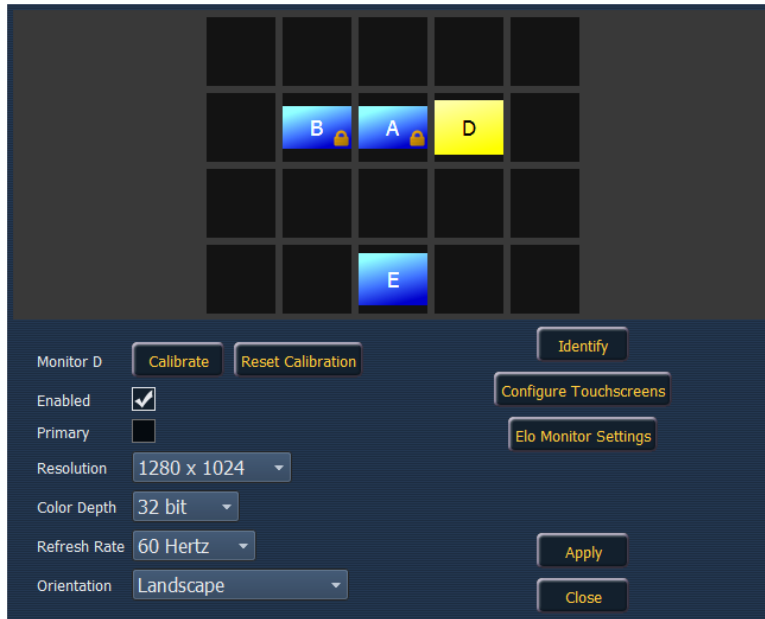

**Note:** The selected monitor will display in yellow. External monitors can be dragged to any of the surrounding black boxes to mimic actual monitor layout. Internal monitors are locked in relationship to each other and cannot be changed.

The Monitor Arrangement Tool will dictate how and where the pointer moves from one screen/monitor to another. Generally speaking, you will want the logical placement on this screen to match your physical placement.

Buttons available in the External Monitor Arrangement display are:

- **{Calibrate}** - see [Calibrate Touchscreens \(on the previous page\)](#).
- **{Reset Calibration}** - restores default calibration data for selected display.
- **{Identify}** - displays the video port numbers that your monitors are connected to on the physical monitors to confirm where you have placed them.
- **{Enabled}** - When checked, the monitor is available for use. The desk will display the **{Enabled}** box checked for any monitors it recognizes.
- **{Primary}** - selects which monitor will display the Eos Configuration Utility and Central Information Area (CIA). On Eos, the primary is locked to the right touchscreen on the desk.
- **{Resolution}** - sets how many pixels the monitor will display.

- **{Color Depth}** - sets how many colors will be displayed.
- **{Refresh Rate}** - sets the number of times in a second the monitor refreshes.
- **{Orientation}** - sets the monitor layout.
- **{Apply}** - will save and use your settings. A window will open asking if you want to **{Keep Changes}** or **{Revert}** back to the defaults. **{Revert}** will be selected within 15 seconds if nothing else has been selected first.
- **{Close}** - will close the display. **{Close}** will not save any settings if **{Apply}** has not been used.
- **{Configure Touchscreens}** - is used to map the touch screens to the displays.
- **{Elo Monitor Settings}** - opens the properties window for the monitor. See [Calibrate Elo Touchscreens \(on page 456\)](#).
- **{ETC Monitor Settings}** - opens the properties window for the monitor. See [Calibrate ETC Touchscreens \(on the previous page\)](#)



**Note:** Only supported options will display. Monitor options may vary. While it is possible to assign a resolution lower than the minimum (1280x1024), it is recommended to be at 1280x1024 or higher.



**Note:** The settings for the on-board monitors are read only.

## Software Update

Software Update allows the installation of Eos Family Software and other ETC-approved software (GCE and NCE). Updating Eos Family Software does not affect or update the software in any other networked device such as a Net3 Gateway.

When you click on **{Software Update}**, the desk looks at the root directory of any connected USB drive for an Eos Family desk software update file. You will be shown the names of any updater files found on the drive. Select the file you would like to install and click the **{Install}** button, or click **{Cancel}**. The software will first save to the hard drive before opening the installer.

You will also receive a message if no software update file can be found.

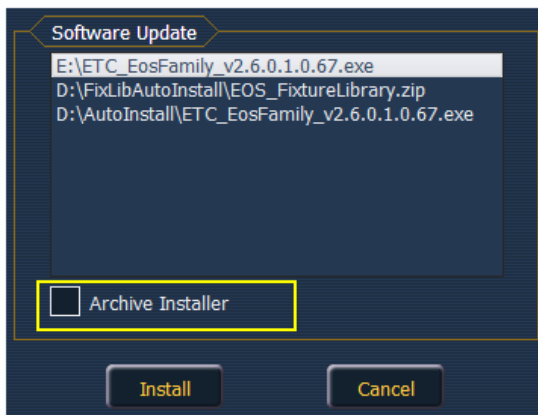

## Installer Archive

Eos has an installer archive, which saves selected installers directly onto the console's local hard drive. You can save multiple software versions onto your console's hard drive in case you wish to downgrade.

While installing the software, you can archive the installer used. Check the Archive Installer box for the selected version, and it will archive while installing the software. If you would like to archive installers without installing their software, you can do that by using the File Manager utility in **ECU>Settings>Maintenance**.

You can also retrieve these versions from the archive to save them to a USB drive by using the File Manager.



**Note:** *On new consoles, some versions are preselected to be archived when it initially ships from ETC. This includes the version of software that is currently installed from the factory as well as any patches to that version (if available). For future release, you will need to download the Eos Family software from the ETC website, [etconnect.com](http://etconnect.com).*

---

## Fixture Library Updates

{Software Update} also recognizes .zip files provided by ETC, which contain fixture library files.

Fixture library update files are distributed as a .zip file, which can be installed on Eos Family consoles, ETCnomad PC, and ETCnomad Mac devices.

### Updating with a .zip file

1. Select the desired .zip file from the Software Update window.
2. You will be asked to confirm that you want to install the selected file. Click **{Yes}** to continue or click **{No}** or **{Cancel}** to return to the Software Update window.
3. A window will open showing the progress of extracting the .zip file. The installer will then launch after the file has been extracted.

## Network Settings

The following options are available in this display :

- [Local Area Connection](#)
- [Enable Remote Startup/ Shutdown](#)
- [Network Interface Delay](#)
- [Ping](#)
- [Output Protocols](#)
- [Interface Protocols](#)
- [DHCP Service](#)
- [Update Service \(TFTP\)](#)
- [Time Service \(SNTP\)](#)

### Local Area Connection

These are the settings that determine the **method** to get an IP address and/or the **actual IP** address information that Eos uses for network communication.

Console	Port 1	Port 2
Status	Online	Offline
Obtain an IP automatically	<input type="checkbox"/>	<input checked="" type="checkbox"/>
IP address	10.101.92.101	<input type="checkbox"/>
Subnet mask	255.255.0.0	<input type="checkbox"/>
Default gateway	<input type="checkbox"/>	<input type="checkbox"/>
Physical address	00-20-0c-6c-9f-45	00-c0-16-01-4b-95
<input type="checkbox"/> Remote Startup		
<input type="checkbox"/> Remote Shutdown		
<input type="button" value="Ping..."/>		



**Note:** *Eos Ti, Gio, Gio @ 5, Ion Xe, Element 2, RPU3, and RVI3 have dual NICs. Eos has a single NIC.*

## Status

This reports if the port is "Online" (configured, connected to a network and operational). It reports as "Offline" if any one of the above conditions is not true.

## Obtain an IP Automatically



**Note:** *ETC recommends the use of a static IP address for compatibility with other ETC devices, though the needs of your particular installation may vary.*

Clicking in the enable box will set the desk to get its IP address dynamically from a DHCP server. While the desk is starting, it will ask for an IP address from a DHCP server. If one responds, it will use the assigned IP address.

If no DHCP server is available, the desk will default to a self-generated link-local IP address in the range of 169.254.x.y. The IP address used by the desk in this configuration may change dynamically as needed. A change should typically only occur when there are changes to the network configuration or to resolve an IP address conflict.

Enabling or disabling the DHCP setting will require you to reboot the desk for the new setting to take affect.



**Note:** *You cannot set the desk to receive an IP address via DHCP and act as a DHCP server at the same time. It can either send dynamic addresses or receive them, but not both at the same time.*

## IP Address

If DHCP is **disabled**, you set the IP address here. This is a static IP address and will remain set until changed by a user.

The following is a list of the default IP addresses:



Console	Port 1	Port 2
Eos	10.101.90.101	NA
Eos RPU	10.101.95.101	NA
RVI	10.101.85.101	NA
Eos Ti	10.101.92.101	192.168.92.101
Gio	10.101.91.101	192.168.91.101
Gio @ 5	10.101.98.101	192.168.98.101
RPU3	10.101.93.101	192.168.93.101
RVI3	10.101.86.101	192.168.86.101
Ion	10.101.100.101	NA
Ion Xe	10.101.100.20	192.168.100.20
Ion Xe 20	10.101.100.30	192.168.100.30
Ion Xe RPU	10.101.96.201	192.168.96.201
Element	10.101.97.101	NA
Element 2	10.101.99.101	192.168.99.101

If DHCP is **enabled**, this field will display the IP address that is being used by the desk (whether it is served via DHCP or a self-generated link-local IP address).

### **Subnet Mask**

If DHCP is **disabled**, you set the subnet mask here. This is a static setting and will remain set until changed by a user. The default subnet mask is 255.255.0.0.

If DHCP is **enabled**, this field will display the subnet mask that is being used by the desk (whether it is served via DHCP or a self-generated link-local IP address).

### **Gateway**

If DHCP is **disabled**, you set the gateway IP address here. This is a static gateway IP address and will remain set until changed by a user.

The following is a list of the default Gateway addresses:

Console	Port 1	Port 2
Eos	10.101.90.101	NA
Eos RPU	10.101.95.101	NA
RVI	10.101.85.101	NA
Eos Ti	10.101.92.101	192.168.92.101
Gio	10.101.91.101	192.168.91.101
Gio @ 5	10.101.98.101	192.168.98.101
RPU3	10.101.93.101	192.168.93.101
RVI3	10.101.86.101	192.168.86.101
Ion	10.101.100.101	NA
Ion Xe	10.101.100.20	192.168.100.20
Ion Xe 20	10.101.100.30	192.168.100.30
Ion Xe RPU	10.101.96.201	192.168.96.201
Element	10.101.97.101	NA
Element 2	10.101.99.101	192.168.99.101

If DHCP is **enabled**, this field will display the gateway IP address that is being used by the desk (whether it is served via DHCP or a self-generated link-local IP address).

## Physical Address

The physical address is the MAC address. This address is a unique identifier and cannot be modified.

## Enable Remote Startup/ Shutdown

It is possible to remotely power on and off some devices, such as RVIs, RPU's, and client desks.



**Note:** *Eos desks cannot be remotely powered on.*

{Remote Startup} and {Remote Shutdown} must be enabled on each device before it can receive the power on and off commands. The default setting for both is Disabled.

The Remote Power commands are sent from the browser. The command for Power On is sent from **Browser>Network>Power On MultiConsole System**, and the command for Power Off is from **Browser>Network>Power Off MultiConsole System**.



**Note:** *Only devices that synchronize with the Primary will be available for Remote Power On and Off.*

## Network Interface Delay

When {Required} is enabled, the console will wait for the network connection to be fully initialized before launching the Eos application.



**Note:** *This option is not available on ETCnomad.*

Console	Port 1	Port 2	
Status	Offline	Online	
Obtain an IP automatically	<input checked="" type="checkbox"/>	<input type="checkbox"/>	
IP address		192.168.51.114	
Subnet mask		255.255.0.0	
Default gateway			
Physical address	00-20-0c-6c-9f-45	00-c0-16-01-4b-95	
Required	<input type="checkbox"/>	<input type="checkbox"/>	(Required = delay Eos launch until the specified network interfaces are online)
Remote Startup	<input type="checkbox"/>		
Remote Shutdown	<input type="checkbox"/>		
Ping...			

When enabled, a launching window will display on start-up. If a network connection is not made, you will have the option to {Start Anyway}, {Start Offline}, or to {Cancel}.

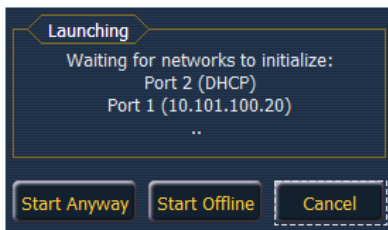

- {Start Anyway} - launches without a network interface. Only User 1 is displayed above the CIA.

- **{Start Offline}** - starts in offline mode.
- **{Cancel}** - remains in start-up without launching into the Eos application.

## Ping

Ping is used to test the network connection between two devices.



## Output Protocols

This is for selecting which protocols the desk will output and which ones are included in the default.

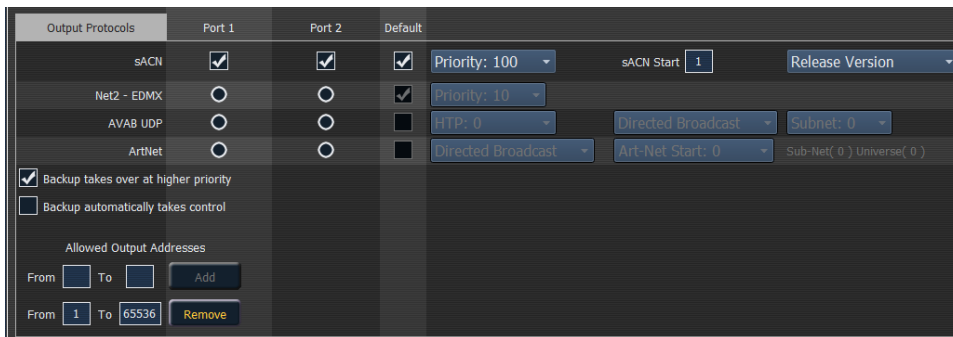

**Note:** sACN can be output on both ports. All other output protocols can only be output on a single NIC.

### sACN

This sets the control priority and the starting address for sACN data from your console. The valid range for this setting is 1 (lowest) to 200 (highest). This is the reverse of EDMX.

Eos allows you to use any sACN universes from 1-63,999. The number of universes that can be used at a time is limited to a block of 256 contiguous universes. The address range equals 1 to 32,767,488, which is 63,999 times 512.

Eos and the Net3 Gateways support two versions of sACN, the draft version and the final ratified version. The ratified version is outputted by default unless this is selected.

### Net2-EDMX

This sets the control priority for EDMX data from this desk. The valid range for this setting is 20 (lowest) to 1 (highest). This is the reverse of sACN.

## ***Avab UDP***

This sets the subnet for Avab UDP data from this desk. The priority levels range from 0-200. The default is 0, which is no priority level. 1 is the lowest priority level and 200 is the highest. When set to no priority level (0), the data will merge according to HTP.

A backup desk will receive its Avab UDP priority level from the primary. The backup will then output at one priority higher than the primary, unless the primary was set to the highest priority of 200.

## ***ArtNet***

This sets the subnet for ArtNet data from this desk. The valid ArtNet Start range for this setting is 0-255.

## **Broadcast Type**

- **Directed Broadcast** - Broadcast packets are directed to a subnet based on the IP address and subnet mask of the sender.
- **Limited Broadcast** - The limited broadcast address is 255.255.255.255. It is limited because routers will never forward datagrams with that destination address. This means that datagrams with the limited broadcast address are confined to the particular network segment on which they originate.

## ***Backup Takes Over At Higher Priority***

This enables the backup device in a multi-console system to take over at one priority higher than the master if the master goes offline.

## ***Backup Automatically Takes Control***

Switches to the backup automatically if the primary should go offline.

## ***Allowed Output Addresses***

A range or ranges of addresses that can be assigned to limit the number of output addresses. The default setting is to allow addresses 1 through 32767488.

## **Interface Protocols**

### ***MultiConsole***

Clicking in the enable box will allow for multiconsole communication on the selected port. See [Multi-console and Synchronized Backup \(on page 441\)](#).

### **Network Type**

This setting adjusts the timeout period before a backup device will take control from the master.

- **Standard**- After five seconds of no response from the master, the backup will assume the master has disconnected and will then take control.
- **Engineered** - After 1.6 seconds of no response from the master, the backup will assume the master has disconnected and will then take control.

### **File Transfer**

This settings adjusts the show file transfer speed between devices. The default setting is Fast File Transfer.



**Note:** If you are experiencing connection issues between devices, you can change the setting to Normal File Transfer for a slower transfer speed.

---

### **Enable Sensor/ FDX3000 Feedback**

Clicking in the enable box will allow your console to receive feedback over the network from a CEM+, a CEM3, or FDX3000. This option is “Enabled” by default. See [\[About\] Address \(on page 371\)](#) for more information.

### **RDM**

RDM can be enabled to allow Eos to perform RDM functionality including device discovery for each ethernet port on a console. By default, RDM is enabled.

See [{Patch} Display and Settings \(on page 123\)](#) and [\[About\] Address \(on page 371\)](#) for more information.

---



**Note:** RDM requires use of a Net3 or Response Gateway. Net3 Gateways must be using version 5.1 or higher.

---

### **FDX2000 Feedback**

Clicking in the enable box will allow your console to receive FDX2000 dimmer feedback over the network.

### **Broadcast Type**

- **Directed Broadcast** - Broadcast packets are directed to a subnet based on the IP address and subnet mask of the sender.
- **Limited Broadcast** - The limited broadcast address is 255.255.255.255. It is limited because routers will never forward datagrams with that destination address. This means that datagrams with the limited broadcast address are confined to the particular network segment on which they originate.

### **WiFi Remote**

Select to allow WiFi RFRs, like the iRFR or aRFR, to connect to Eos.

### **UDP and OSC Strings**

Clicking in the enable box will allow the selected port to send UDP and OSC strings.

### **OSC**

Select the OSC TCP mode. By default, OSC 1.0 is selected.

---



**Note:** Check the documentation for the OSC device you wish to use over a TCP connection to see which mode it supports.

---

- OSC 1.0 (packet-length headers)
- OSC 1.1 (SLIP)

### **DHCP Service**

---



**Note:** All settings in this section require a reboot of the desk before they will take effect.

---

If this section is grayed out, or you are unable to change any settings, you don't have Net3 Services installed on your desk. Net3 Services are installed by the installer for ETC's Gateway Configuration Editor (GCE) software. GCE is available for download from the ETC website.

Eos can provide a DHCP (Dynamic Host Configuration Protocol) address server. DHCP is a TCP/IP protocol that dynamically assigns an IP address to a network device when it requests one.

This is a small and simple DHCP server that is intended to be used on non-routed networks. It will not serve IP addresses across a router.



**CAUTION:** *There should only be a single DHCP server active on a network. It is possible to start more than one DHCP server on a single network (nothing is built-in to DHCP servers to prevent this from happening). If this occurs, it will result in unstable conditions and possibly result in network communications failures.*

---

Clicking in the enable box will start the DHCP server in the Eos desk. It will use the settings below to determine which IP addresses it gives out.

- **First IP Address**- This sets the starting IP address of the range of IP addresses the DHCP server will give out.
- **Number of Addresses** - This sets how many IP addresses the DHCP server will give out. A setting of 500 means it will give out IP addresses to the first 500 devices that ask for an IP address.
- **Subnet Mask** - This sets the logical network size vs. the device address. ETC's default is 255.255.000.000 (class B). This is the subnet mask that the DHCP server will give to network devices.
- **Routed** - If checked, you can use the default gateway box, below, to specify the gateway you would like DHCP devices to use. If unchecked, the DHCP server will serve the same value for both the devices IP address and gateway, which is a suitable configuration for non-routed networks.
- **Default Gateway**- This specifies the IP address of a router if one is present on your network. This is the gateway IP address that the DHCP server will send to network devices to use.

**If you are on a flat or non-routed network**, the Gateway IP address should match the IP address of the device. In order to configure this DHCP server to send out matching gateway IP addresses, **configure this gateway IP address to match the IP Address Pool field**. Then the DHCP server will give out a gateway IP address that matches the IP address.

## **Learn Network Devices**

Clicking this button will trigger the DHCP service to search the network for existing devices, and add them to its table of known addresses. If you have equipment with statically assigned IP addresses in your network, this will ensure the DHCP service does not serve out any IP addresses which conflict with those devices.

## **Update Service (TFTP)**

Clicking in the enable box will start the TFTP (Trivial File Transfer Protocol) server.

- **Update File Path** - This sets the directory where files are to be served through TFTP. This must be the full path to the directory, including drive letter. For example: C:\etc\nodesbin

## Time Service (SNTP)

Clicking in the enable box will start the SNTP (Simple Network Time Protocol) service. You determine if the service is running as a client (receiving time messages) or as a server (sending time messages).

- **Client/ Server** - When configured as a client, a desk will attempt to synchronize its time with the rest of the devices in the system, by listening for time information and altering its own clock. When configured as a server, a desk will serve out time to other devices on the network, acting as a time “master”
- **ETC Net2 Time** - With ETC Net2 Time enabled, the time server will periodically broadcast (as a server) or receive (as a client) the current time, which is required by devices running the ETCNet2 protocol, for example, Legacy Unison systems.
- **External Time Server** - The External Time Server option allows you to synchronize your desk to a third party time system at a specific IP address using the NTP or SNTP protocols. This allows use of a specific time clock for time sync. This requires a high accuracy time clock on your network.
- **External Server IP** - If External Time Server is enabled, you will need to specify the IP address of your external NTP or SNTP time server in this field.

## Maintenance

The following options are available in this display:

- [Deep Clear](#)
- [Save Logs](#)
- [Backup Show Archive](#)
- [Restore Show Archive](#)
- [Backup and Restore System Settings](#)
- [Face Panel Test](#)
- [Classic Peripheral Test](#)
- [File Manager](#)
- [GCE](#)
- [Concert](#)
- [UpdaterAator](#)
- [Touch Screen Test](#)
- [Upgrade Console](#)
- [Upgrade I/O Firmware](#)
- [Network Drives](#)
- [Shared Folders](#)
- [Log Off](#)
- [Firmware Update](#)

## Deep Clear

**{Deep Clear}** functions in much the same way that “New” does from the File menu or “Reset System” does from the Clear menu (both are found within the Browser). A deep clear is automatically performed when new software is installed. Sometimes it is useful to perform a deep clear between updates.

The advantage of deep clear is that you can clear all desk data before reloading the desk’s current state during boot. This is helpful if you are moving a new desk onto the network and don’t want it to suddenly take control of a system or if you somehow end up with a corrupt show file that is causing issues upon boot.

It's worth noting that Deep Clear (like Reset System and **File>New**) does not reset any of the settings in the Eos Configuration Utility (ECU) like its operational mode or IP address settings. Everything in the ECU remains as it was last configured.

## Save Logs

Clicking on the **{Save Logs}** button displays a dialog box prompting you to save the desk log files for troubleshooting purposes. You have the option to select/ deselect any of the various individual log files to be saved.

By clicking on the **{Advanced}** button, you can select or deselect any of the various individual log files to be saved.

Clicking **{Next}** you will be able to provide additional information, the date, and time of the issue.

Clicking **{Next}** again you will see a drop down menu to select the target export location from any available write-enabled removable media such as a USB drive.

If you experience software problems with your system that we are unable to reproduce, sending these log files to ETC Technical Services (see [Help from ETC Technical Services \(page 1\)](#)) can help us isolate the issue.

## Backup Show Archive

**{Backup Show Archive...}** allows you to either backup the most current version of each show file or every version of each file to a USB drive.

## Restore Show Archive

**{Restore Show Archive...}** allows you to restore show files from a USB drive.

## Backup and Restore System Settings

These settings allow you to backup and restore all of the ECU system settings, including Net3 services.

This is useful for sharing settings between consoles, including ETCnomad.

### ***Backup System Settings***

**{Backup System Settings}** will open a window that allows you to save .ini file to a selected drive. To backup settings, select a drive from the drop down menu, and press **{Accept}** to save or **{Cancel}** to exit without saving.

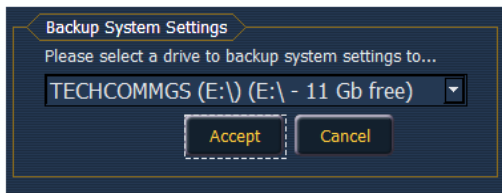

### ***Restore System Settings***

**{Restore System Settings}** will open a window that allows you to select a saved.ini file. Select the desired file and press **{Ok}** to restore settings. Press **{Cancel}** to close the window without restore settings.



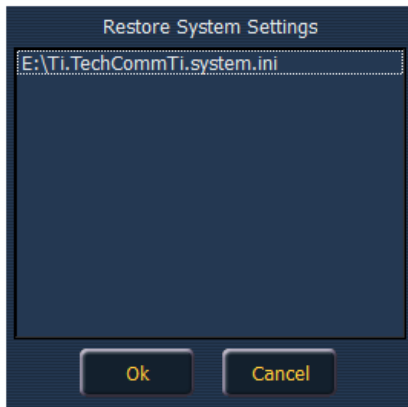

## Face Panel Test

{Face Panel Test} provides a way to verify the functional state of all of the keys, encoders, and faders on the Eos. Press/ move every key, encoder, and fader to verify that those events register on the diagnostic test screen.

## Classic Peripheral Test

{Peripheral Test} allows you to test peripherals such as fader wings.

## File Manager

{File Manager} provides a way to manage show files. You can create and delete new folders, move, and copy files between the desk and USB drives.

The file manager display will show the ShowArchive folder on your desk as well as any external USB drives that are detected. The display is split into two windows, so you can see two different folders at the same time for copying or moving data between them.



## GCE

If installed on your console, the {Gateway Configuration Editor (GCE)} button will display.

## Concert

If installed on your console, the {Net3 Concert} button will display.

## UpdaterAtor

If installed on your console, the {UpdaterAtor} button will display.

## Touch Screen Test

{Touch Screen Test} opens an application for testing your touchscreens.

## Upgrade Console

{Upgrade Console...} is used for upgrading the desk's outputs.

## Upgrade I/O Firmware

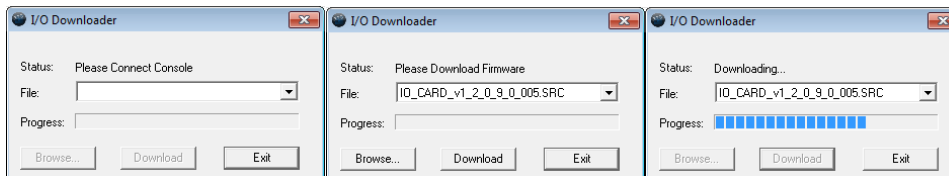

**Note:** This option is for use with older I/O cards.

**{Upgrade I/O Firmware}** is used to upgrade the firmware in the desk's I/O card.

When you first open the I/O Downloader, it will look for the connected console. This may take a second or two.

Once the console is found, the downloader will search for the needed files. If it finds the file, it will list it and you can click **{Download}**. If it doesn't find the file, you can use **{Browse}** to look for the needed file and selected it. Once finished, click **{Exit}**.

## Network Drives

**{Network Drives...}** allows you to select an alternative show file storage location on another desk or computer. After setting this location, it will appear as an option within the save and open dialogs in Eos.

In the **{Network Drives...}** dialog box, there is a **{Add}** button for mapping a network drive. In the Add Network Drive dialog box, select the drive letter that is appropriate, the network path, and the path type. The network path can use either the IP Address or the Device Name. (Example: \\10.101.90.101\ShowArchive or \\YourDeviceName\ShowArchive) The network path type can be Eos, Eos Ti, Gio, Gio @ 5, Ion, Ion Xe, Ion Xe 20, Ion Xe RPU, Element, Element 2, or ETCnomad Puck. If Other is selected, you will have additional fields to fill out for Username and Password.

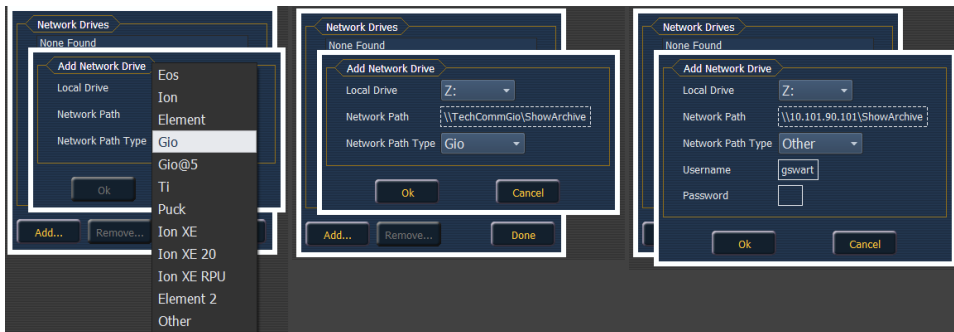

## Shared Folders

**{Shared Folders...}** allows you to see if any folders are currently being shared by the desk. You can select the folder and click **{Don't Share}** if you no longer want to share the folder. By selecting **{Don't Share}** here, you will also uncheck the box for [Share Show Archive \(on page 456\)](#) in the General tab.

## Log Off

This will log off the current user. This should only be done under the direction of ETC Technical Services for administrative purposes.

## Firmware Update

The firmware update window will display any detected devices that use firmware and may require an update. Devices that need to be updated will display in red.

When a device is selected, the **{Update}** button will display in yellow if the device can be updated using this window. This includes devices that do not currently need to be updated. If the button is grayed out, the device can not be updated using this window.

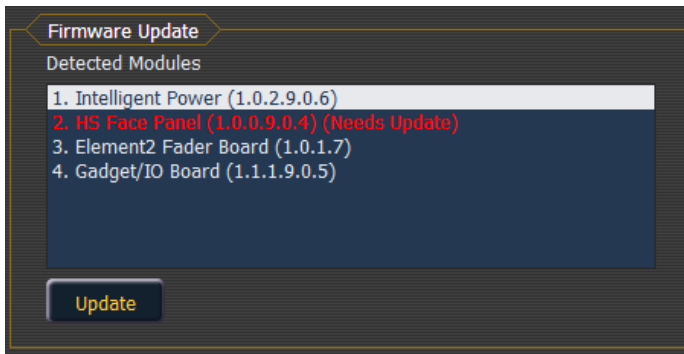

## Buttons

### RPU Face Panel Buttons

This area is for configuring the buttons on the front of a RPU or RVI. Clicking on a button will open a dialog window for selecting what type of button, macro, hardkey, or none, you wish to assign.

If hardkey is selected, a list of the various hardkeys on your desk will be available to select from. If macro is selected, a list of available macros will display. Selecting none will assign no action to the selected button.

**{Import}** allows you to import a RPU/RVI button configuration file. **{Export}** allows you to export a RPU/RVI button configuration file. **{Restore Defaults}** will restore the factory defaults for the RPU/RVI buttons.

For more information, please see the Setup Guide for your RPU. Setup Guides can be downloaded from the ETC website, [etcconnect.com](http://etcconnect.com).

### Face Panel Buttons

This area is for configuring the buttons the customizable hardkeys on the Eos Ti, Gio, and Gio @ 5 facepanels.

Clicking on a button will open a dialog window for selecting what type of button, macro, hardkey, or none, you wish to assign.

If hardkey is selected, a list of the various hardkeys on your console will be available to select from. If macro is selected, a list of available macros will display. Selecting none will assign no action to the selected button.

**{Import}** allows you to import a button configuration file. **{Export}** allows you to export a button configuration file. **{Restore Defaults}** will restore the factory defaults for the buttons

See [Customizable Hardkeys \(on page 24\)](#) for more information.

## RFR

This screen is used for setting up the Radio Focus Remote (RFR) to work with Eos.



**Note:** *These settings need to match between the desk and the RFR.*

---

### High Frequency Channel

The frequency that the RFR is using. There are 1-12 channels.

## **Network ID**

The Network ID is a separate digital channel on a single high frequency (HF) setting. There are 1-99 IDs available.



# Chapter 30

## Show Control

---

Eos Family consoles support a variety of show control protocols. Specific information about using each type of show control can be found in each type's section.

About Eos Family Show Control .....	476
Show Control Settings .....	477
Show Control Display .....	484
Time Code .....	487
Real Time Clock (RTC) .....	491
Analog Inputs .....	493
sACN Input .....	497
MIDI Show Control .....	499
String Interface .....	504
MIDI Raw .....	511
Open Sound Control (OSC) .....	519
Eos Family Show Control Capabilities .....	541
Advanced OSC .....	543
Eos OSC Keys .....	559

## About Eos Family Show Control

The following is an overview of the show control types and general setup information.

The Eos Family can use the following show control protocols:

- **SMPTE** - An analog signal indicating time (subdivided into hours, minutes, seconds, and frames) that is used to sync events between multiple devices. Eos Family consoles receive SMPTE from a Net3™ Show Control Gateway. The consoles will only receive SMPTE, and do not send it.
- **MIDI Time Code (MTC)** - A digital version of SMPTE sent over MIDI. MTC can be received through a local MIDI In port or through a Net3 Show Control Gateway. The consoles will only receive MTC, and do not send it.
- **Real Time Clock (RTC)** - Events can be triggered from the date and time on the console. With the correct location information, this includes astronomical events like sunrise and sunset.
- **Analog** - 0-10VDC inputs or contact closure inputs through a variety of interfaces. 0-10VDC inputs are received through a Net3™ I/O Gateway. Contact closures can be received through the built-in closures on the desk (when available) and through a Net3 I/O Gateway.
- **Relays** - Normally closed and normally open contact closure outputs (SPDT). One relay is available on consoles that have built-in I/O ports. Multiple relays are available on Net3 I/O Gateways.
- **MIDI Show Control** - A standardized subset of MIDI System Exclusive (SysEx) commands used for show control. Eos Family devices can send or receive these messages. MIDI can be sent through the built-in MIDI ports (when available) and through a Net3 Show Control Gateway.
- **ASCII String Interface (Serial (RS232)/Network Serial)**- ASCII text strings, also known as plain text strings. These can be sent or received on the network via a UDP message, or sent via RS232 serial on a Net3 I/O Gateway.
- **MIDI Raw** - Also known as MIDI Strings, MIDI Notes, or Channelized Event Data. Originally intended for communication between musical instruments, MIDI has been adapted for a variety of uses between devices. Eos Family consoles can send or receive MIDI messages through the built-in MIDI ports (when available). A Net3 Show Control Gateway supports only MIDI Time Code and MIDI System Exclusive messages (including MSC).
- **Open Sound Control (OSC)** - A network protocol using UDP/IP or TCP/IP over wired or wireless networks. It is used for communication between varying audio, video, and lighting devices. OSC can be sent and received from the console.
- **sACN Input** - These incoming levels can be used to trigger show control actions. The console combines all incoming sACN levels for an address and uses the level from the highest priority source. If there are multiple sources at the same priority, it uses the highest level (HTP). The console will include its own sACN levels.

Most protocols that are received need to be configured in a Show Control list in the show control display. These include MTC, SMPTE, Analog Inputs, RTC, MIDI Notes, Serial Strings, and sACN Input. The Show Control list is accessed by pressing **[Displays]>{Show Control}**. See [Show Control Display](#) for more information.



## Show Control Settings

In [Setup]>[System]>[Show Control], you can adjust settings for MIDI Show Control, time code (MIDI or SMPTE), analog, and serial functions. See [Show Control Setup \(below\)](#)

### Show Control Setup

This section allows you to adjust settings for MIDI show control, time code (MIDI or SMPTE), analog, and serial functions. For more information on using show control with your system, see [About Eos Family Show Control \(on the previous page\)](#)

#### **Device Settings (Local MIDI/SMPTE)**

##### **{MIDI/SMPTE Rx}**

Enables or disables the console's ability to locally receive MIDI or SMPTE. Defaults to "Enabled."

##### **{MIDI Tx}**

Enables or disables the console's ability to locally transmit MIDI. Defaults to "Enabled."

##### **{Time Code ID}**

Sets the console's local Time Code ID.

##### **{USB MIDI/SMPTE}**

Enables or disables local USB connection to supported MIDI or SMPTE devices. This setting must also be enabled for Virtual MIDI devices.

#### **SMPTE**

##### **{SMPTE Time Code Rx}**

This button is used to control whether your console can receive SMPTE time code. Choosing "Disabled" will disable all time code lists that have a SMPTE source. The default for this setting is "Enabled".

##### **{Resync Frames}**

This button allows you to configure how many frames need to be synced before time code starts running. Frames can be from 1-30. Default is 2 frames.

#### **MIDI - MSC**

##### **{MSC Receive}**

This button toggles the setting for receiving MIDI Show Control from an external source between "Enabled" and "Disabled". The default setting is "Disabled".

##### **{MSC Transmit}**

This setting, when enabled, allows the console to send MSC messages for actions taken on the console, such as cue actions, macros firing, and submaster bumps. The default setting is "Disabled".

## **{MSC Rx Device ID}**

This setting allows you to choose the devices from which the console will receive MSC. When set, the console will respond to MSC data from any Net3 gateway that has a matching "ACN MSC Rx ID." Gateways will send the MIDI data over an ACN connection. When built-in MIDI ports are available, the setting needs to match or at least contain the MSC Rx ID.

### **Example:**

- {MSC Rx Source ID} [2] [5] [Enter]
- {MSC Rx Source ID} [1] [Thru] [1][0] [Enter]

## **{MSC Tx Device ID}**

This setting allows you to choose the devices which the console will send MSC to.

## **{MIDI Cue List}**

MIDI Cue List specifies the cue list that the console will use to send MSC data. If left blank and MSC Tx is enabled, all cue lists will generate MSC events. Otherwise, only the particular list (or lists) selected will fire MSC events.

## ***MIDI - Network***

## **{MIDI Rx Device ID}**

Also known as a "device ID" this setting configures the MIDI channel for the console to receive MIDI Show Control information. Only MSC data with the same device ID will be received. A device ID can be from 0-126. MSC commands can be sent to ID 127, which is the All Call device ID. While Eos cannot be set to ID 127, it will respond to commands sent to the All Call device ID.

### **Example:**

- {MSC Rx Device ID} [5] [0] [Enter]

## **{MIDI Rx Device ID}**

Also known as "Device ID" this setting allows you to set the device ID with which your console will transmit MIDI Show Control information. A device ID can be from 0-127. If set to 127, the console will transmit MSC data to all devices (All Call).

### **Example:**

- {MSC Rx Device ID} [5] [0] [Enter]

## **{MIDI Tx Source ID}**

This setting allows you to choose the devices through which the console will send MIDI data. When set, the console will transmit MSC data from any Net3 gateway that has a matching "ACN MIDI Tx ID." The console will then send the MIDI data over an ACN connection to the gateways. When built-in MIDI ports are available, the setting needs to match or at least contain the MIDI Tx ID.

## Example:

- {MIDI Tx Source ID} [2][5] [Enter]

## MIDI - MTC

### {MIDI Time Code Rx}

As above, but for MIDI Time Code instead of SMPTE. Defaults to "Enabled."

## Contacts

### {Analog Inputs}

This is a master setting for receiving analog inputs from a Net3 I/O Gateway or the built-in I/O port (when available). When disabled, it will no longer trigger any analog input actions on any event lists. Default is "Enabled".

### {Relay Outputs}

This is a master setting for triggering external relays from a Net3 I/O Gateway or the built-in I/O port (when available). When disabled, will no longer affect any external relays normally triggered from the desk via cues, submasters, or macros. The default is "Enabled".

### Contact Closure (remote trigger connector)

Allows you to set the Group and Address In values for the remote trigger input on the back of your console. The contact closure only reports on/off even though it is considered an analog input.



**Note:** The contact closures require DC voltage, which is supplied by the console on pins 14 and 15. See the diagram below.

## Relay Out

Allows you to assign the Relay Out Source ID and the Relay Out Address.

### Remote Trigger Connector Pinout

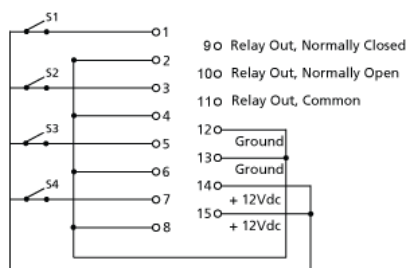
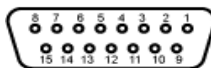

## OSC

### {OSC RX}

Globally enables receiving OSC.

### {OSC RX Port Number}

This setting specifies the UDP port that the console will listen to for OSC receiving strings. Multiple ports can be assigned. A space needs to be used to separate the addresses.



**Note:** ETC recommends using 8000 and 8001 respectively for port numbers. Remember that when setting port numbers on your external device that they should be set to the opposite of what Eos is set. For example, if **{OSC TX Port Number}** on Eos is set to 8000, then the RX (incoming) port on your external device needs to be set to 8000, and vice versa.

---

### {OSC Cue Recv String}

Allows the user to specify a different incoming OSC string format for integration with other applications. Use %1 in the string format as cue number and %2 as the cue list number.

### {OSC TX}

Globally enables transmitting OSC.

### {OSC TX Port Number}

This sets the UDP destination port to which the console will send OSC strings. Multiple ports can be assigned. A space needs to be used to separate the addresses.

### {OSC Cue Send String}

Allows the user to specify a different outgoing OSC string format for integration with other applications. Use %1 in the string format as cue number and %2 as the cue list number.

### {OSC TCP Custom Ports}

Allows the user to specify custom port numbers for multiple OSC TCP connections.

### {OSC TX IP Address}

This sets the destination IP address or addresses to which the console will send OSC strings.



**Note:** Be careful when using a network with a DHCP server. If your external device reboots or is issued a new IP address from a DHCP server, it will no longer receive OSC strings from Eos until you change this setting to match your new IP address at your external device.

---

### {OSC USB}

Allows use of OSC USB devices, such as Lighthack.

## ***String UDP***

### **{String RX}**

This setting will enable receiving strings on all Serial RX formats.

### **{String RX Source IDs}**

This setting allows you to choose the Net3 I/O Gateways through which the console will receive serial strings. When set, the console will receive serial from any Net3 I/O Gateway that has a matching "ACN Serial Group ID." The gateway will send serial data over an ACN connection to the console. This only affects serial traffic from I/O gateways and not network UDP messages, ACN strings, or OSC. Serial Group IDs can be from 1-32. Multiple group IDs can be selected by using [Thru] and [+].

### **{String RX Source Name}**

Allows the user to specify a comma separated list of names for receiving strings, for example, from Paradigm.

### **{String RX Port}**

This setting specifies the UDP port that the console will listen to for receiving strings. Multiple ports can be assigned. A space needs to be used to separate the addresses.

### **{String TX}**

This settings will enable sending strings on all Serial TX and OSC formats.

### **{String TX Source IDs}**

This setting allows you to choose the Net3 I/O Gateways through which the console will transmit serial string data. When set, the console will transmit serial to any Net3 I/O Gateway that has a matching "ACN Serial Group ID." The console will send the serial data over an ACN connection to the gateways. This only affects serial traffic to I/O gateways and not network UDP messages, ACN strings, or OSC. Serial Group IDs can be from 1-32. Multiple group IDs can be selected by using [Thru] and [+].

### **{String TX Source Name}**

Allows the user to specify a list of specific comma-separated names of devices to send strings to (for example, for use with Paradigm).

### **{String TX Port}**

Setting for the UDP destination port that the console will send strings. Multiple ports can be assigned. A space needs to be used to separate the addresses.

### **{String TX IP Address}**

Sets the destination IP address or ACN devices supporting the ACN String EPI that the console will use to send strings. This can contain either an IP address for UDP string destinations or ACN device names.. A combination of UDP and ACN devices are not supported. Please see [String Interface](#) for more specific configuration information.

## {String MSC TX}

When enabled, this setting will cause the console to send serial strings when certain actions happen at the console. See [Sending From User Events](#).

## Port Setup Options

Eos Ti, Gio, Eos RPU3, Gio @5, Ion Xe, Element 2, Ion, Ion RPU, Element, and Eos Programming Wing have additional ports and connectors located on the rear panel for show control. Additional setup options for these ports and connectors are in the ECU>{Settings}>{Local I/O} and in ECU>{Settings}>{Network}.



**Note:** The built-in I/O ports on these devices will not broadcast information over the network and are only used in a local console system.

---

## MIDI Rx and MIDI Tx Group IDs

Allows you to set the group number for the MIDI In and MIDI Out ports. Group numbers can be from 1-32. Default for both ports is 1.

To receive MIDI from the built-in ports, the ACN MIDI Rx ID in Setup>{System}>{Show Control} must match the MIDI Rx Group ID in the ECU. To transmit MIDI from the local ports, the ACN MIDI Tx ID in Setup>{System}>{Show Control} must match the MIDI Tx Group ID in the ECU.

---



**Note:** While Gio@5 has contact closure ports, it does not have local MIDI ports. A Show Control gateway is required for MIDI input.

---

## Contact Closure (remote trigger connector)

Allows you to set the Group and Address In values for the remote trigger input on the back of your console. The contact closure only reports on/off even though it is considered an analog input.

---



**Note:** The contact closures require DC voltage, which is supplied by the console on pins 14+15. See the diagram in [Relay Out \(remote trigger connector\) \(below\)](#).

---

## Relay Out (remote trigger connector)

Allows you to set the Group and Address In values for the remote trigger port on the back of your console.

Remote Trigger  
Connector Pinout

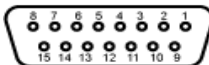

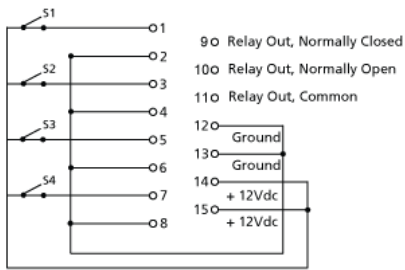

## Interface Protocols

Additional settings are found in the **ECU>Settings>Network**.

Interface Protocols	Bench Gigabit Network	
MultiConsole	<input checked="" type="checkbox"/>	Standard Network <input type="button" value="Fast File Transfer"/>
Sensor/FDX3000 Feedback	<input checked="" type="checkbox"/>	
RDM	<input checked="" type="checkbox"/>	(requires Net3 gateway 5.1 or higher)
FDX2000 Feedback	<input type="checkbox"/>	Directed Broadcast <input type="button" value=""/>
WiFi Remote	<input type="checkbox"/>	
UDP Strings & OSC	<input checked="" type="checkbox"/>	
OSC		TCP format for OSC 1.0 (packet length headers) <input type="button" value=""/>

See [Open Sound Control \(OSC\)](#) for more information.

## Show Control Display

The Show Control Display allows for the creation of event lists, which are comprised of events. An Event List defines how incoming show control events are processed by the console – any protocol that can be received by the console is handled here. Each event list uses a different type of show control at a time (time code, analog inputs, RTC, or network). Specific information about setting up events for each show control type can be found later in this guide.

The show control display can be accessed by pressing **{Show Control}** on the Display Management Home Screen.

## Settings

In addition to the show control display, your console provides additional user-definable settings for show control which can be accessed by pressing **[Displays]>{Setup}>{System}>{Show Control}**. For more information, see the [Show Control Settings](#).

## Events

The upper portion of the show control display shows the specific events that are contained in each event list. An event consists of an input condition, such as a timestamp, real time, an address, or input value, and an action. An event plays back (or “fires”) when the input condition is met (for example, the timecode passes the given timestamp, or a contact closure at the given address changes). Multiple events can be fired at the same time; however a single action can only be placed in each event.

Eos Family consoles support three event actions:

- Cues can be run.
- Submasters can be bumped, faded (via analog only), and turned on and off.
- Macros execute without interaction with the command line, unless the macro is set to foreground mode.



**Note:** If another macro is fired before the first macro completes, the first macro will finish its action before the second is started.



**Note:** If a macro is selected as the intended action, it will fire using the macro mode specified. Please see [Macro Editor Display \(on page 391\)](#) for information on macro modes.

---

Event	Time	Date	Action	Label
1	Sunset-00:30	Mon Tue Wed Thu	Cue 1	outdoor lights on
2	Sunset-00:30	Fri Sat Sun	Cue 2 / 1	lobby lights on

List	Label	Type	Source	Internal	External	First Time	Last Time	FPS	Status
1		RTC		On					Enabled
2		SNPTE	1	Off	Off	00:00:00:00	23:59:59:29	30	

Softkeys are available for the various event options:



- **Event** - is the event number, used to select or create a specific event from the command line. Can also use **[Next]/[Last]** to select/navigate through the events.



**Note:** The event number is not fixed, it is just provided as a way to select an event. For example, in time code lists, the events are always chronological. The event number will change to match the chronology.

- **Time/Address** - used to specify the conditions when the event should trigger the action. This could be time code, time of day, sACN levels, MIDI input, string input, OSC input, or an address used for analog inputs.



**Note:** Time can be assigned to a list of events by using a range.

- `{Event}[1] [Thru] [1][0] [Time] [1] [Thru] [1] [0] [Enter]`

- **Date**- used to specify when the event should trigger the action, used only for RTC. See [Real Time Clock \(RTC\)](#).
- **Action** - is what the event is going to trigger; can be a cue, submaster, macro, or level by address, which sets the parameter at the assigned address to the incoming level manually.
  - `{Event} [1] [/] [1] {Action} {Level By Address} [2] [/] [1] [Enter]`
- **Label** - names a specific event.

## Event List

The lower portion of the show control display contains the event lists used in the console. Events are contained within a specific event list (like cues within a cue list). Each event list has a specific show control protocol type that it uses: MIDI, SMPTE, Analog, or RTC. Getting started with an event list is the same regardless of which show control protocol you are using.

Event	Time	Date	Action	Label
1	Sunset 00:30	Mon Tue Wed Thu	Cue 1	outdoor lights on
2	Sunset 00:30	Fri Sat Sun	Cue 2 / 1	lobby lights on

List	Label	Type	Source	Internal	External	First Time	Last Time	FPS	Status
1		RTC		On					Enabled
2		SMPTE	1	Off	Off	00:00:00:00	23:59:59:29	30	

Softkeys are available for the various event list options:

- **List** - is the event list number.
- `<Event> [1]/[/][Enter]` - creates event list 1.
- **Label** - names the event list.
- **Type** - sets which type of show control protocol to use; MTC, SMPTE, Analog, Network, or RTC. Only one protocol can be used at a time per list.
- **Source** - should match the Group ID used in the connected Net3 Show Control, I/O Gateway, or the built-in ports (when available).
- **Internal** - enables the list to use internal timing sources. See [Internal vs. External Time](#).
- **External** - enables the list to use external timing sources. See [Internal vs. External Time](#).

- **First Time** - sets the first time that the console will use when using internal timing.
- **Last Time** - sets the last time that the console will use when using internal timing.
- **FPS** - sets how many frames per second (FPS) will be used; 30, 25, 24.
- **Status** - current status of the event list.

## ***Internal vs. External Time***

Time code (MIDI or SMPTE) is typically received from an input source, like a show control gateway. This timing source is referred to as external time, since it is coming from a source external to your console.

If the external time source is not available for any reason, each time code event list within your console has an internal timing source which will assume control, if enabled. This internal timing source requires three pieces of information to determine how to generate its timing: first time, last time, and frame rate. When the internal clock reaches the last time, it will reset to the first time and continue running.



**Note:** *External timing sources may run faster or slower than the console's internal clock.*

---

Real Time Clock uses internal time only, but the clock can sync with an external time server using SNTP. Whether using internal time from the console or using external time from a time server, it is important that all the correct information for time zone, latitude, and longitude are properly setup. Refer to the Configuration Utility appendix in your console's manual for setup information.

Analog inputs and network inputs use the external setting only as a way to enable and disable the entire list.

## **Creating an Event List**

Getting started with an event list is the same regardless of which show control protocol you are using.

To program an event list, you first must open the show control display.

- **[Displays]>>[More SK]>>[Show Control]**

Create an event list by specifying it in the command line.

- **<Event> [1] [/] [Enter]**

Specify what the list will respond to (MIDI, SMPTE, Analog, or RTC).

- **<Event> [1] [/] {Type} {MIDI} [Enter]**

Define the group or source.

- **<Event> [1] [/] {Source} [8] [Enter]**

Activate the internal and/or external timing functions (see [Internal vs. External Time](#)). These functions are toggle on/off states.

- **<Event> [1] [/] {Internal} {External} [Enter]**

When defining an event list, it is feasible to enter multiple commands in the same command line. This can speed up your programming of an event list. For example:

- **<Event> [2] [/] {Type} {MIDI} {Source} [5] [Enter]**

Once the list is created, you will then need to create the specific events. Those steps will vary depending on what protocol is being used.

## Time Code

Eos Family consoles can receive internal or external time code to execute event lists.

Time code lists can receive timing data from either SMPTE or MIDI sources. Eos Family consoles accept up to 32 SMPTE sources and 32 MIDI Time Code (MTC) sources (each are numbered from 1-32). Up to 64 sources can be received simultaneously.

## Enabling Time Code

Eos Family consoles have global settings to enable or disable reception of MIDI Time Code and SMPTE. These are found in setup, See [Show Control Settings](#).

If the MIDI Time Code setting is disabled, all MTC event lists are disabled as well. Each event list can be enabled/disabled individually using the internal and/or external field. Off is disabled, regardless of the global setting in the setup screen. The same is true for SMPTE.

## Timing Data

Timing data is given in the form of (hours) : (minutes) : (seconds) : (frames). Therefore a timing value of 06:25:15:24 would be 6 hours, 25 minutes, 15 seconds, 24 frames.

The number of frames per second is determined by the timing source and the event list must be set to this same number of frames when programming. Number of frames can be 24, 25, or 30.

## Color coding

The color of the time in the Status column of the event list display indicates the source of the timing data. The colors and indications are:

- **Green** - Valid external timing is being received.
- **Red** - The internal clock is the data source and is running.
- **Gray** - No timecode is being received from internal or external sources.

You will also see an indicator in the upper portion of the main display if valid internal or external time is seen. By default, list 1 is shown. If a list other than 1 is displayed, it will be shown with the event list number in front of the current time for the list.

The screenshot shows the console interface with the following data:

Event	Time	Action	Label
1	00:00:50:00	Cue 1	

List	Label	Type	Source	Internal	External	First Time	Last Time	FPS	Status
1		RTC		On					Enabled
2		SMPTE	1	Off	Off	00:00:00:00	23:59:59:29	30	
3		MIDI	1	On	Off	00:00:00:00	23:59:59:29	30	00:00:17:00

## Timing and Clocks

The internal and external clocks can be enabled separately for each time code list. If you enable the external clock only, events will play back as long as valid timing data is received from an external source. When the timing data stops, the events will stop.

When you enable the internal clock only, it starts running immediately and triggers events appropriate to the time.

When both internal and external clocks are enabled, the internal clock does not start running until the first valid external time is received. After that, it will run whenever the external time source is absent.

## ***Loop Times***

First and last times define the overall loop. Times can be set anywhere from 00:00:00:00 to 23:59:59:29. When external time is being received, your console ignores these times. However, you should still set them to match whatever loop times the external clock is using. When using internal timing, it is important to set the first and last times. These set the start and stop or loop points of the sequence.

## ***Internal Clock***

You can set the internal clock at any time by selecting the event list (<Event List> [1] [/]), pressing [Time], and entering a time.

To reset the internal clock, select the event list and press [Time] [Enter].

## **Programming a Time Code Event List**

Open the show control display.

- [Displays]><More SK>>{Show Control}

Create a new event list.

- <Event> [1] [/] [Enter]

Define the type of input.

- <Event> [1] [/] {Type} {MIDI} [Enter]

Define the source of input (this is the source ID number of the Gateway 1-32).

- <Event> [1] [/] {Source} {1} [Enter]

Specify if internal and/or external timing is enabled.

- <Event> [1] [/] {Internal} {External} [Enter]

Define the first time and last time for the event list (times are given as 00:00:00:00).

- <Event> [1] [/] {FirstTime} [2] [0] [1] [5] [Enter]
- <Event> [1] [/] {LastTime} [2] [0] [4] [5] [1] [5] [Enter]

Specify the number of frames per second (FPS) used by the timing source (24, 25, or 30).

- <Event> [1] [/] {FrameRate} [2] [5] [Enter]

When working in Live, to show the Time Code times in the Cue List, go to the Cue List Display.

- [Cue] [Cue]

Select the Cue List to be triggered.

- [Cue] [1] [/]

Now associate the Event List to the Selected Cue List.

- [Cue] [1] [/] {Execute} {Timecode} {1} [Enter]

Both the Event List and the Cue List are ready for events to be added. There are three ways that events can be added into the Event List.



**Note:** You will notice as events are added in the Event List that the time code will display on the Playback Status Display.

---



**Note:** This is the same process for MIDI and SMPTE Time code.

---

## Adding Events from the Show Control Display

Events can be added directly from the show control display, however a new event number must be specified for each event action.

Open the show control display.

- [Displays]><More SK>>[Show Control]

Select the event list.

- <Event> [1] [/] [Enter]

Specify a new event number.

- <Event> [1] [Enter]

Add the action that the event should execute.

- <Event> <1> [Cue] [1] [Enter]
- 



**Note:** As there is no action softkey, pressing [Cue], [Sub], or [Macro] assumes you are posting to the action field.

---

Define the time code position of the event.

- <Event> <1> [Time] [2][0][1][5] [Enter]

It is possible to enter multiple commands in the same command line. This can speed up your programming.

- <Event> [2] [Cue] [1.5] [Time] [2][4][1][3] [Enter]

Event timing can also be modified within a range. Let's say an additional 5 frames needs to be added to multiple events.

- <Event> [1] [Thru] [4] [Time] [+] [5] [Enter]
- 



**Note:** You will notice as events are added to the event list, the time code will display on the Playback Status Display.

---

## Adding Events From Live

Events can be added directly from live using the same conventions used in the Show Control Display. The advantage to doing this from Live is there is no need to specify the event number, as the console automatically assigns the number.

From the Live Display Select the cue to execute.

- [Cue] [3]

Now define the time code location.

- [Cue] [3] {Execute} {Timecode} [3][2][1][5] [Enter]



---

**Note:** You will notice as events are added to the event list, the time code will display on the Playback Status Display.

---

## Adding Events using Learn Mode

If you select an event list within the show control display, you can press the **[Learn]** hardkey to activate learn mode for that event list. When in learn mode, an event is created with the current list time whenever a cue is activated, a submaster bump is pressed, or a macro is run. Once in learn mode, the **[Learn]** key will remain lit to indicate that it is in learn mode. If the show control display is exited, the console remains in learn mode until deactivated.

Multiple time code lists can be in learn mode simultaneously, each with their individual times. It is recommended that you associate the event list and cue list together, so events will be learned into the intended time code list.

To exit learn mode, the console must be in the show control display. Once there, select the event list then press **[Learn]** again. If **[Learn]** is pressed while viewing any other screen than the show control display an empty event will be placed on all event lists that are in learn mode.

Open the show control display.

- **[Displays]<More SK>{Show Control}**

Select the event list to enable learning on.

- **<Event> [1] [/]**

Press the **[Learn]** key.

- **<Event> [1] [/] [Learn]**

In the Status column it now says Learning, and the **[Learn]** button is illuminated.

A **{Learn Events}** softkey is available in the event list. This macro-able item allows you to enable and disable show control learn mode. Macros containing this softkey will not be included in learned events. Other Macros can be learned as events in an Event List. Use **{SC Learn}** softkey in the Macro Editor to enable/ disable excluding specific Macros from being learned as events. See [Macro Editor Display \(on page 391\)](#)

## Execution While Editing

If the internal or external clock is running, events will fire, even if you are in the edit screen. As soon as an event is created, the event list is resorted, and the new event is eligible for playback.

## Real Time Clock (RTC)

Eos Family consoles have the ability to run Real Time Clock (RTC) events. RTC events are used to run a cue, submaster, or macro at a specific time on specific days. RTC events can run at a certain time of day, like 5:00pm on Tuesdays, a certain date, or at a time based off of astronomical events, such as sunrise and sunset.

### Enabling Real Time Clock

For astronomical (sunrise and sunset) events to work properly, time zone, latitude, and longitude must be set up correctly. Those settings are found under the General tab in the Eos Configuration Utility (ECU).



**Note:** In the *ECU >Network >Time Service (SNTP)*, you can configure the SNTP server or client so that the console can synchronize time across the network with other devices, such as Paradigm®.

---

For all RTC events, the option for internal must be set to on within the show control display. As long as the internal option is set to on, the RTC events will execute. However if internal is set to off, then the events will not trigger. The status in the show control list will indicate whether it is on or off. There is no way to disable a single event from triggering within the event list, you can only remove the event number.

### Real Time Clock Events

RTC events are created using the [Show Control Display](#). RTC events consist of a time field, a day or date field, and an action. Time for RTC events can be specified as local time or as time relative to the astronomical events, sunrise and sunset. Local time is displayed in the 24 hour format. For example, if you want an event to run at 2:50pm, you would need to set it for 14:50.

### Programming Real Time Clock Events

Open the show control display.

- [Displays] <More SK> {Show Control}

Create a new event list.

- <Event> [1] [/]

Specify the event list as RTC.

- <Event> [1] [/] {Type} {RTC} [Enter]

Enable the RTC.

- <Event> [1] [/] {Internal} [Enter]

Define the Time and Date for each event.

---



**Note:** Commands cannot be combined on the same command line.

---

- <Event> [1] [Time] [1] [5] [0] [0] [Enter] - sets the time for 3:00pm.
- <Event> [1] {Days} {Mon} {Wed} {Fri} [Enter] - adds on Mondays, Wednesdays, and Fridays.



**Note:** Days of the week can either be entered in from their softkeys, or you can enter them in from the keypad using the conventional modifiers (+, -, thru). Monday is 1.

---

Define the Astronomical Time and Date.

- **<Event> [2] [Time] {Before Sunset} [3] [0] [Enter]** - sets the time for 30 minutes before sunset.
- **<Event> [2] {Days} [1] [+] [2] [+] [3] [+] [6] [Enter]** - adds on Monday, Tuesday, Wednesday, and Saturday.

Define the Astronomical Time and Date.

- **<Event> [3] [Time] {After Sunrise} [6] [0] [Enter]** - sets the time for an hour after sunrise.
- 



**Note:** The events will renumber themselves to be in the correct order of execution throughout the day. Event 3 is now listed as Event 1. The command line will change to Event 1 automatically.

---

- **<Event> [1] {Date} [2] [1] {Month} [1] [0] {Year} [2] [0] [1] [5] [Enter]** - sets the date to October 21, 2015.

Creating the action for each event is the same as time code. Select the event and specify either cue, submaster, or macro.

- **<Event> [1] [Cue] [1][2] [Enter]**
- 



**Note:** As there is no action softkey, pressing **[Cue]**, **[Sub]**, or **[Macro]** assumes you are posting to the action field.

---



## Analog Inputs

Eos Family consoles can accept analog input through a variety of interfaces. 0-10VDC inputs are received through a Net3 I/O Gateway. Contact closures can be received through the built-in remote trigger port on the desk (when available) and through a Net3 I/O Gateway. The I/O Gateway can be set up through the Net3 Concert software. For more information, please refer to the Net3 I/O Gateway Setup Guide. For setting up your console's local ports, including the pin-out of the connector, see [Show Control Setup \(on page 477\)](#).

Analog inputs are programmed through the show control display, where each analog event in the event list consists of a port address and an action. Each event list source references a specific Group ID, which needs to match the ACN Group ID of the I/O Gateway or the Group ID of the built-in remote trigger port, and the events themselves are assigned addresses for the individual addresses or inputs within the gateway.

To enable the analog event list, the internal time option must be enabled. This is an enable/disable function for the entire event list. There is also a global enable for all analog inputs found in Setup; for more information, see [Show Control Setup \(on page 477\)](#).

## Analog Input Events

There are two types of analog input events – contact closures and 0-10VDC inputs.

Contact closures will fire an event the input circuit is closed. Events that can be triggered this way include running a cue, controlling a submaster, and firing a macro. The event is only triggered as the closure occurs. It will not be triggered again as the circuit is opened.

0-10VDC inputs can be used to control a submaster fader proportionally, where 0VDC represents 0% on the fader and 10VDC represents 100% on the fader. When assigned to a contact closure style of event, like a Sub Bump, the event will be triggered when the input passes 6.67VDC. The input must then pass below 3.3VDC and then above 6.67VDC to trigger the event again. This is designed to prevent the event from firing too many times, in case the input has noise that causes the voltage to fluctuate.

### Create an Analog Event List

Open the show control display.

- [Displays]<More SK>{Show Control}

Create a new event list.

- <Event> [4] [/] [Enter]

Define the type of input.

- <Event> [4] [/] {Type} {Analog} [Enter]

Define the source of input.

- <Event> [4] [/] {Source} {1} [Enter] (This is the Source ID# of the Gateway.)

Specify the event list to be active.

- <Event> [4] [/] {Internal} [Enter]

Create an analog input event where an input on address 1 will fire cue 10.

- <Event> [4] [/] [1] {Analog Address} [1] [Cue] [1] [0] [Enter]



**Note:** As there is no action softkey, pressing **[Cue]**, **[Sub]**, or **[Macro]** assumes you are posting to the action field.

## Actions

Cues, macros, and submasters can all be triggered from analog inputs (contact closure or analog voltage above 6.67V) or **sACN Input**.

### Cues

Execute the cue with its programmed cue timing.

Create an event where an input on address 2 will fire cue 11.

Analog input:

- **<Event> [4] [/] [1] {Address} [2] [Cue] [1] [1] [Enter]**

sACN input:

- **<Event> [4] [/] [1] {sACN} [2] [Cue] [1] [1] [Enter]**

### Macros

Triggers the macro and begin execution immediately.

Create an event where an input on address 3 will fire macro 1.

Analog input:

- **<Event> [4] [/] [1] {Address} [3] [Macro] [1] [Enter]**

sACN input:

- **<Event> [4] [/] [1] {sACN} [3] [Macro] [1] [Enter]**

### Submasters

There are four modes: On, Off, Bump, and Fader.

#### On

The submaster will act as if the bump button was pressed and held down. This will toggle, or release the same state, when activated again.

Create an event where an input on address 4 will set Sub 1 to On.

Analog input:

- **<Event> [4] [/] [1] {Address} [4] [Sub] [1] {On} [Enter]**

sACN input:

- **<Event> [4] [/] [1] {sACN} [4] [Sub] [1] {On} [Enter]**

#### Off

Used to release the submaster's bump button when triggered from a Sub On action elsewhere in a show control action

Create an event where an input on address 5 will set Sub 1 back Off.

Analog input:

- **<Event> [4] [/] [1] {Address} [5] [Sub] [1] {Off} [Enter]**

sACN input:

- <Event> [4] [/] [1] {sACN} [5] [Sub] [1] {Off} [Enter]

## **Bump**

Acts as if the input is directly controlling the bump button. If the submaster is set to have a dwell time of Man (manual), then it will instantly flash and turn back off. It is generally recommended to set the submaster to have a dwell time of Hold or a specified time. The first trigger will turn the submaster On. If the submaster is set to a dwell time of Hold, the second trigger will turn the submaster Off.

Create an event where an input on address 6 will bump Sub 1.

Analog input:

- <Event> [4] [/] [1] {Address} [6] [Sub] [2] {Bump} [Enter]

sACN input:

- <Event> [4] [/] [1] {sACN} [6] [Sub] [2] {Bump} [Enter]

## **Fader**

Acts as if the input is directly controlling the fader on the submaster. A contact closure will move the fader from 0 to 100% instantly. A 0-10VDC input will fade the value proportionally, where 0VDC is the fader at 0%, and 10VDC is the fader at 100%.

Create an event where an input on address 7 will control the fader for Sub 3.

Analog input:

- <Event> [4] [/] [1] {Address} [7] [Sub] [3] {Fader} [Enter]

sACN input:

- <Event> [4] [/] [1] {sACN} [7] [Sub] [3] {Fader} [Enter]

## Relay Outputs

Eos Family consoles can trigger relay outputs on Net3 I/O Gateways and on the built-in relay output (when available). Relay outputs are also often called remote triggers, contact closures, or contact outputs. Relay outputs are controlled by external links in cues and submasters only.



**Note:** *You enter relay information in the live or blind displays. This is not a Show Control display function.*

---

### Example:

- [Live] [Cue] [1] {Execute} {Relay} [1] [/] [2] {On} [Enter] - 1 is the ACN Group ID of the I/O Gateway or built-in relay output and the 2 is the relay output address.

## sACN Input

Eos Family consoles can receive streaming sACN level information from itself and other devices on the lighting control network. Similar to Analog Inputs, these received sACN input levels can then be used by the Event List display to execute certain actions.

sACN allows for multiple sources to be present on the network. These sources (configured at the transmitting device) are each given a priority. The valid priority range is 1 (lowest) to 200 (highest) with 100 as the default. When determining the winning level for an address, the level with the highest priority will be used. If the sources have the same priority, the highest level will be used (also known as Highest-Takes-Precedence, or HTP).

sACN Inputs can be assigned to events. These events can run a cue, control a submaster, or fire a macro. Submasters can be turned On, Off, trigger the Bump button, or control the fader. See [Actions](#).

With the exception of a submaster fader and bump, sACN Input will fire an event when the level rises above 50% (DMX 127). It does not fire again when the level drops below 50% (DMX 127). It only fires again when the level drops below 50% and then rises above 50%.

Submaster bump will act as if the bump button was pressed when the level rises above 50% (DMX 127), and acts as if the bump button was released when the level drops below 50%.

sACN Input Events

### Using sACN Input

#### ***Run a Cue Based on sACN Input***

Open the Show Control Display

- [Displays] > <More SK>> {Show Control}

Create a new event list

- <Event> [8] [/] [Enter]

Define the type of input

- <Event> [8] [/] {Type} {Network} [Enter]

Create a new event

- <Event> [1] [Enter]

Assign the sACN address using universe/address format

- {sACN} [4] [/] [1] [Enter]

Add the action to execute. Actions can be either a cue, submaster, or macro

- {Action} {Cue} [1] [Enter]

#### ***Control a Submaster Fader Based on sACN Input***

Open the Show Control Display

- [Displays] > <More SK> > {Show Control}

Create a new event list

- <Event> [8] [/] [Enter]

Define the type of input

- <Event> [8] [/] {Type} {Network} [Enter]

Create a new event

- **<Event> [2] [Enter]**

Assign the sACN address using universe/address format

- **{sACN} [4] [/] [2] [Enter]**

Add the action to execute. Actions can be either a cue, submaster, or macro

- **{Action} {Sub} [1] {Fader} [Enter]**

## MIDI Show Control

Eos Family consoles can receive MIDI Show Control (MSC) data from Net3 Show Control Gateways and the built-in MIDI ports on a console or programming wing (when available). There can be up to 32 sources, and these sources can be assigned Group IDs between 1 and 32. MIDI Show Control is one of many different types of MIDI signals – MIDI Time Code and MIDI Notes are supported, but described elsewhere in this document. All other incoming MIDI is ignored.

Eos Family consoles can also transmit MIDI Show Control data.

### MIDI Show Control Devices

MIDI Show Control data carries a device ID (MIDI channel) within the data packet. MSC setup, see [Show Control Settings](#), allows you to specify two device IDs: one for reception and one for transmission. This is different than the ACN Group Tx and Rx IDs, which are the show control gateway source ID and transmitting ID. The show control gateway, assigned an ACN Group Tx and Rx ID, can send MIDI messages to and from several Device IDs all on the same MIDI line.

Only MSC data that matches the MSC Receive Channel in Setup, or an All Call ID (127), will be interpreted by your console.

All outgoing MSC data contains the specified transmit device ID, as specified in Setup, see [Show Control Settings](#).

### Eos Family Command Interpretation

MIDI Show Control commands contain a Command Format, or device type that is intended to receive a message. Eos Family devices will respond to Lighting—General messages. All other command formats are ignored.

Eos Family consoles can receive the following MSC commands:

- **Go** - runs a cue.
- **Stop** - pauses a cue.
- **Resume** - resumes a paused cue.
- **Set** - controls a submaster, playback, or Grandmaster.
- **Fire** - runs a macro.

In addition to the command and command format, the MSC commands also contain places for transmitting devices to provide additional data, or data fields, which further specify the intended action, like a submaster number. When Eos Family consoles output MSC, these fields cannot be edited and correspond to the cue, submaster, or macro that is being executed.

The cue-related commands (go, stop, resume) have three fields – Cue Number, Cue List, and Cue Path. Cue Path is not used by the console. Cue Number and Cue List are optional fields – if they are not provided, the console runs the next cue on the master fader on the console. The Cue List and Cue Number field, if provided, should match a cue list and/or cue number on the console.

In the command/ effect tables below, if a field is present in the MSC data, the name is indicated (such as “Cue”). If it is not present in the data, a “-” is indicated.

#### Go

When accompanying a MIDI “Go” command, data for the following fields will result in the following actions:

Cue Data Field	List Data	Field Action
Cue	List	Runs the specified cue in the specified cue list

Cue Data Field	List Data	Field Action
Cue	-	Runs the specified cue in cue list 1
-	List	Runs the next cue in the specified list
-	-	Runs the next cue in cue list 1

## Stop

When accompanying a MIDI “Stop” command, data for the following fields will result in the following actions:

Cue Data Field	List Data	Field Action
Cue	List	Stops the specified cue & list (if running)
Cue	-	Stops the running cue in cue list 1
-	List	Stops the current cue from the specified list
-	-	Stops the running cue on the master fader of the console that received the command

If a cue is not currently running (or already stopped), the Stop command will trigger Back, fading back to the previous cue.

## Resume

When accompanying a MIDI “Resume” command, data for the following fields will result in the following actions. If there are no stopped cues, this action is ignored.

Cue Data Field	List Data	Field Action
Cue	List	Resumes the specified cue & list (if stopped)
Cue	-	Resumes the specified cue in the default cue list
-	List	Resumes the current cue in the specified list
-	-	Resumes all stopped cues

## Set

The “Set” command allows MSC to control specific faders using both a numeric control value (which specifies the fader number) and a data field (which controls the level: 0-100). Control values are as follows:

Control Value	Data Field	Indication
1-127	0-100	Submaster 1-127
128	0-100	Primary playback in
129	0-100	Primary playback out
510	0-100	Grandmaster

All other control values are ignored.



**Note:** See [Hexadecimal and MIDI Show Control Formatting](#) for information on formatting MIDI messages.

## Fire

This command fires a macro. MSC supports macros 1 through 127 only. Therefore a numeric value of 1 through 127 followed by 00 (in hex) would accompany this command.



## Sending MIDI Show Control

When MSC Transmit is enabled in Setup (see [Show Control Settings](#)), the console will send MIDI Show Control commands to the specified MSC Transmit Channel (or Device ID) that correspond to the console's current action. For example, if Cue 1 in List 2 is executed, the console will send a MSC Go command for Cue 1 List 2.

The console will send the following MSC commands:

- **Go** - runs a cue
- **Stop** - pauses a cue
- **Resume** - resumes a paused cue
- **Fire** - runs a macro

Set commands (for submasters, the playback pair, and grandmaster) are not transmitted from Eos Family devices.

## Hexadecimal and MIDI Show Control Formatting

When configuring other devices to send or receive MIDI Show Control, you may need to consider the hexadecimal data that is sent as a part of a MIDI Show Control command. Many software packages manage this formatting for you, but some instances require you to enter this manually. The following notes are intended as a quick reference for common use cases. For a more exhaustive reference on MIDI Show Control message formatting, please refer to the book referenced at the beginning of this guide – *Show Networks & Control Systems* by John Huntington.

### Structure

A MIDI Show Control string can be written as a short hexadecimal message.

An example string would be:

- F0 7F 01 02 01 01 31 00 31 F7

There is a structure to these strings – this is what the same string looks like with the parts that can be modified identified in brackets:

F0 7F [**device\_ID**] 02 [**command format**] [**command**] [**command\_data**] F7



**Note:** For Eos Family products, the command format field is always 01, for Lighting – General.

---

The following commands discussed earlier in this document have the following command codes:

- **Go** - runs a cue = **Command 01**
- **Stop** - pauses a cue = **Command 02**
- **Resume** - resumes a paused cue = **Command 03**
- **Set** - controls a submaster, playback, or Grandmaster = **Command 06**
- **Fire** - runs a macro = **Command 07**

The other parts of the string are standardized. F0 7F and the ending F7 are parts of the standard MIDI System Exclusive message format. The 02 specifies the protocol is MIDI Show Control.

### Go, Stop, Resume

The cue commands can target any available cue on the console. Hexadecimal doesn't natively handle decimal numbers, so the numbers are sent in a different format (ASCII text encoding).

There are four simple rules for formatting:

1. Specify the cue number first, and then the cue list
2. Place a "3" in front of every digit of the number
3. Place a "2E" wherever there is a decimal
4. Place a "00" when separating a cue number from the cue list

Examples include:

- **Eos** - Cue 1/54
- **MSC Formatted** - 35 34 00 31
- **Eos** - Cue 4/101
- **MSC Formatted** - 31 30 31 00 34
- **Eos** - Cue 10/55.6
- **MSC Formatted** - 35 35 2E 36 00 31 30
- **Eos** - Cue 3/ (no cue number provided – play next cue in list 3)
- **MSC Formatted** - 00 33
- **Eos** - Cue 1 (no cue list provided – assumes cue list 1)
- **MSC Formatted** -31 00

For example, sending Device ID 3 a GO command for cue 5.4 in list 99 would be formatted as follows:

F0 7F 03 02 01 01 35 2E 34 00 39 39 7F

### ***Setting Submasters, Playback Masters, or Grandmasters***

Submasters from 1-127 are represented as values 01 to 7F

The master playback "up" fader (128) is represented as two hexadecimal numbers in a row - 00 01.

The master playback "down" fader (129) is represented as two hexadecimal numbers in a row – 01 01.

The grandmaster fader (510) is represented as two hexadecimal numbers in a row – 7E 03.

There are three simple rules for formatting:

1. Level values are sent as 0-100 in decimal form, which would be sent as 00-64 in hexadecimal
2. Submasters – send the fader number, followed by 00 (in hex), then the level value, and finally 00 (in hex).  
For example, sending submaster 1 to 100% would be sent as 01 00 64 00.
3. Playback Masters and Grandmasters – send the fader number, followed by 00 (in hex), and then the level value. You do not need to end the command with 00.  
For example, setting the grandmaster to 75% would be sent as 7E 03 00 4B

For example, sending Device ID 3 a SET command for sub 4 to 0% would be formatted as follows:

F0 7F 03 02 01 06 04 00 00 00 7F

As a second example, sending Device ID 10 a SET command for the playback master "up" fader to 100% would be formatted as follows:

F0 7F 0A 02 01 06 00 01 00 64 7F

## ***Firing Macros***

Macros are relatively simple. Only macros 1-127 can be triggered, represented by one hexadecimal byte.

- **Eos** - Macro 12
- **MSC Formatted** - 0C

For example, sending Device ID 5 a FIRE command for macro 17 would be formatted as follows:

F0 7F 05 02 01 07 11 F7

## String Interface

RS232, UDP serial strings, ACN EPI strings, and OSC commands can be sent and received from the console.

### Enabling Serial

You can configure sending and receiving the various serial protocols supported by the desk in Setup, see [Show Control Settings](#). Most string protocols are disabled by default.

The Eos Configuration Utility, or ECU, also contains settings that control which network interface is allowed to send and receive UDP, ACN Strings, and OSC messages. See [ECU>Settings>Network>Interface Protocols](#) for more information.

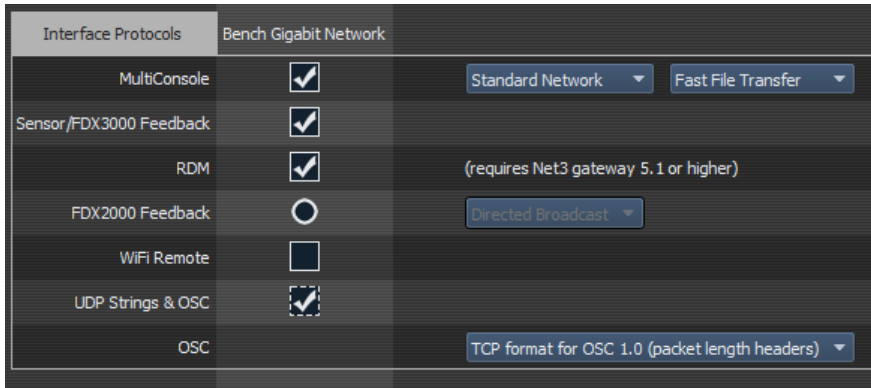

## Receiving Eos Serial Commands – RS232, UDP, and ACN EPI Strings

All text will be queued up until either a carriage return (hex 0D), a “\r”, or a “#”, is encountered in the string to show the end of the command.

### Command Line

If the text begins with a “\$”, the text that follows until the carriage return (hex 0D), a “\r”, or a “#” will be sent to the command line for user 0 and processed as if that user had typed it. Commands can be directed to a specific user command line by adding <UX> at the beginning of the string, where X is replaced by the intended user number. The carriage return (hex 0D), a “\r”, or a “#” will also act as the [Enter] key for the command line.

#### Example:

- **\$ Chan 1 Color Palette 1#** - puts channel 1 into color palette 1 on the background user (User 0).
- **<U2> \$ Chan 1 Thru 10 At Full /r** - sets channels 1 through 10 to full manually on User 2’s command line.



**Note:** It is best practice to place spaces after both the <UX> and the \$ symbol to ensure the command is interpreted properly.



**Note:** Command line text needs to use the same language as your console. Language settings are found in [ECU>General](#).

## Event Handler (Non-Command Line)

All other text that doesn't start with a "\$" will be sent to the console's event handler. Here are a few examples:

- **Go 1** - fire cue list 1
- **Cue 1 2** - run cue 2 from list 1, on the appropriate fader
- **Cue 1** - fire pending cue from list 2
- **GoCue 0 1** - clear cue list 1 (fires cue 0)
- **Back\_CueList 1** - run previous cue from cue list 1
- **Release 1** - release cue list 1
- **Off 1** - turn cue list 1 off
- **Resume 1** - resume cue list 1
- **Assert 1** - assert cue list 1
- **Stop 1** - stop playback 1
- **Stop Cue 1 2** - stop cue 2 from list 1 if it is running
- **Stop** - stops all
- **Resume Cue 1 2** - resume cue 2 from list 1 if it is stopped
- **Resume** - resumes all
- **SubAssert 1** - assert submaster 1
- **SubUnload 1** - unload sub 1
- **SubDown 5** - presses sub 5's bump button down
- **SubUp 5** - releases sub 5's bump button



**Note:** *Faders are accessed by adding 1000 to the fader number. This would affect any palettes or presets assigned to the fader. Subs must be used with their sub number only.*

---

### Example:

- **SubMove 1 25** - moves Sub 1 to 25%
- **SubMove 1001 50** - moves Fader 1 to 50%
- **SubMove 1011 75** - moves Fader 11 (fader 1 on page 2) to 75%
- **SubDown 1101** - presses Fader 101's bump button down (fader 1 on page 10)

- **FaderMove\_CueList 1 50** - sets cue list 1's playback fader to 50 percent
- **Grandmaster 1 100** - set Grandmaster 1 to full (there's currently only 1 Grandmaster)
- **Macro 1** - fires Macro 1



**Note:** *Text requires either a carriage return (hex 0d), "\r", or "#" to terminate the command line.*

---

## Receiving UDP Strings

UDP strings must be sent to the console's IP address (unicast) and designated port to be processed. Multicast and broadcast UDP strings are not supported. To find your console's IP address, clear the command line and press **[About]**. For more information on About see the About section of your console's manual. The UDP Rx port is configured in Setup. Please see [Show Control Settings](#) for more setup information.

## Receiving ACN Strings

To receive ACN strings, **{String RX}** must be enabled in **Setup>System>Show Control**, and the ACN component name must be set in the **{String TX IP Address}** field with the R: prefix.

For example, the ACN component name could be Paradigm.

```
String TX IP Address
R:Paradigm
```

## Bidirectional ACN Strings (Send and Receive)

To send and receive ACN strings from devices such as a Net3 Gateway, both

{String TX} and {String RX} must be enabled, and the ACN component name must be set in the {String TX IP Address} field with the B: prefix.

For example, the ACN component name could be Net3 4-Port Gateway.

```
String TX IP Address
B:Net3 4-Port Gateway
```



**Note:** If you have multiple devices sending or receiving strings, separate each entry in the {String TX IP Address} field with a comma.

## Receiving via the I/O Gateway

For your console to receive serial data from a Net3 I/O Gateway, the Serial Port Group ID assigned at the gateway must match the String RX Group ID in Setup, and String RX setting in Setup must be Enabled. See [Show Control Settings](#).

## Receiving Serial Commands to Trigger Events

All text will be queued up until either a carriage return (hex 0D), a “\r”, or a “#”, is encountered in the string to show the end of the command. The custom string is case-sensitive.

### RS232, UDP, and ACN Strings

The sending device needs to add SC (case-sensitive) to the beginning of the string in order for it to be correctly processed.

#### Example:

- SC Hello# - sends the string “Hello” to the show control display via RS232, UDP, or ACN

### OSC Strings

For OSC commands that are intended to be processed by the Show Control display, the sending device needs to start the string with /eos/sc/ in order for the console to correctly process it.

#### Example:

- /eos/sc/Hello – sends the string “Hello” to the show control display via OSC

## Event Commands

When a command is received that starts with the prefixes listed above, the console will look for a matching serial event defined in a Show Control List. Custom string input from any serial source (RS232, UDP, ACN, OSC) can be used to trigger the following actions:

- **Cue** - fire a cue
- **Submaster** - bumps a submaster, turns a submaster on or off, sets a submaster to a fader percentage. (Note that OSC cannot be used to set fader levels via custom serial commands).
- **Macro** - fire a macro

## Programming Serial Events

Open the show control display.

- [Displays]><More SK>>{Show Control} or [Tab] + [1][1]

Create a new event list.

- <Event> [9] [/] [Enter]

Specify the event list as Network.

- <Event> [9] [/] {Type} {Network} [Enter]

Enable the list (External only).

- <Event> [9] [/] {External} [Enter]

Select Input String and type the appropriate UDP or OSC command

- {Input String} Hello [Enter]

### OSC

Type in the command you want the console to listen for.

- The sending device needs to start the command with /eos/sc/ in order for the console to listen to it. For example, type Hello in the Input String field. On your OSC sending device, have it send /eos/sc/Hello.

### UDP

Type in the string you want the console to listen for.

- The sending device needs to add "SC" (case-sensitive) to the beginning of the string in order for it to be correctly processed.
- The string needs to be terminated with a carriage return (hex 0D), \r, or #. For example, type Hello in the Input String field. On your UDP sending device, have it send SC Hello#
- To set the submaster fader percentage using UDP, you need to include a number (0-100) after the string. For example, blue 50#.

Then add the action to execute. Actions can be a cue, submaster, or a macro.

- {Action} {Cue} [1] [Enter]

## Sending Serial Commands – RS232, UDP, and ACN Strings

Eos Family consoles have the ability to send strings, which can be used to send commands to other devices, such as Paradigm®, Crestron®, and media servers. The ability to send and receive strings can be done via RS232 ports (via a Net3 I/O Gateway), network UDP messages, and ACN String EPI. Please see [Show Control Settings](#) for more setup information.



**Note:** The console can be configured to send either ACN strings or UDP strings, as they share the String Tx IP Address field. A combination of device names for ACN and IP addresses for UDP is not supported. Combinations of I/O Gateways and either UDP or ACN Strings are allowed.

---



**Note:** If you are trying to control Paradigm via UDP, ACN Strings, or RS-232, please reference the Paradigm Serial Access Protocol document for additional information.

---

## Sending Strings

There are three ways that your console can send strings: from cues, macros, or user events. String TX must be set to Enabled in Setup for any strings to be sent.

### Termination Characters

All strings are appended with CR LF unless the string contains an escape character (in which case no default termination is appended).

### Escape Characters

Non-printable ASCII characters can be placed in the string using the escape characters “\x” followed by the hexadecimal character code. To place a carriage return (CR) in the string, type “\x0D”.

If an escape character is embedded in the string (in any position), then the default termination is not applied.

- **[Cue] [1] {Execute} {Strings} “macro on”** – sends “macro on” with the default CR LF termination
- **[Cue] [1] {Execute} {Strings} “macro on\x0A”** – sends “macro on” with a line feed (LF) termination
- **[Cue] [1] {Execute} {Strings} “macro\x0Don”** – sends “macro <CR> on” with a carriage return in the middle and no termination
- **[Cue] [1] {Execute} {Strings} “\x02\x03”** – sends ASCII characters 0x02 and 0x03 with no termination

### Sending from Cues

Cues can be assigned specific user-defined strings to send. When the cue is executed, the string will be sent to all enabled string interfaces. To assign the string, select the cue and press the **{Execute}** softkey. A **{String}** softkey will be displayed. When **{String}** is pressed, the alphanumeric keyboard will display. Enter the desired string, press **[Enter]** and text entered will be displayed in the external links field of the playback status display.

If there is already a string linked to the selected cue, the string will be displayed for editing. When **[Cue] [n] {Execute} {String}** is on the command line, pressing **[Next]** / **[Last]** will step through all the strings used in that show file. You can then modify the displayed string to simplify the process of entering similar strings.

### Sending a String to Paradigm

Select the cue that should be executing the string.

- **[Cue] [1]**

Press the **{Execute}** softkey.

- **[Cue] [1] {Execute}**



New softkeys will appear, press the **{Strings}** softkey.

- **[Cue] [1] {Execute} {Strings}**

Define the serial string, in this case we will trigger a Macro On in Paradigm.

- **[Cue] [1] {Execute} {Strings} macro on Lights1 [Enter]**

## ***Sending from Macros***

A **{Send String}** softkey is available in the Macro Editor display. Any text entered after the string command in the macro will be sent to all enabled string interfaces when that macro is fired.

## ***Sending From User Events***

**{String MIDI TX}** is an option in **[Setup]>{System}>{Show Control}**. See [Show Control Settings](#). When **{String MIDI TX}** is enabled, MIDI Show Control messages will be sent as serial string messages when certain actions happen at the console.

Those actions are:

- A cue is fired.
- Cue 1/2 is triggered. The console will send Cue 1 2.
- A cue is stopped.
- Cue 3/1 is stopped. The console will send Stop Cue 3 1.
- A cue is resumed.
- Cue 3/1 is resumed. The console will send Resume Cue 3 1.
- A sub's bump button is held down.
- Sub 5's bump button is pressed down. The console will send SubDown 5.
- A sub's bump button is released.
- Sub 5's bump button is pressed down. The console will send SubUp 5.
- A macro is fired.
- Macro 1 is fired. The console will send Macro 1.



**Note:** *String MIDI Tx is restricted by {MIDI Cue List} in Setup. See [Show Control Settings](#).*

---

## ***Sending UDP Strings***

UDP strings will be sent from the console on an ephemeral (always changing) port number to the destination port specified in Setup. UDP strings sent to multicast IP addresses are not supported.



**Note:** *The console can be configured to send either ACN strings or UDP strings, as they share the String Tx IP Address field. A combination of device names for ACN and IP addresses for UDP is not supported.*

---

## ***Sending ACN Strings***

To send ACN strings, **{String TX}** must be enabled in **Setup>System>Show Control**, and the ACN component name must be set in the **{String TX IP Address}** field.

For example, the ACN component name could be Paradigm.

## String TX IP Address Paradigm

If you have multiple devices sending or receiving strings, separate each entry in the **{String TX IP Address}** field with a comma.

---



**Note:** *The console can be configured to send either ACN strings or UDP strings, as they share the String Tx IP Address field. A combination of device names for ACN and IP addresses for UDP is not supported.*

---

## Sending via the I/O Gateway

For your console to send serial data to a Net3 I/O Gateway, the Serial Port Group ID assigned at the gateway must match the String TX Group ID in Setup, and String TX setting in Setup must be Enabled. See [Show Control Settings](#) .

## MIDI Raw

Also known as MIDI Strings, MIDI Notes, MIDI Messages, or Channelized Event Data. Originally intended for communication between musical instruments, MIDI has been adapted for a variety of uses between devices. Eos Family consoles can send or receive MIDI messages through the built-in MIDI ports (when available).

Net3 Show Control Gateways do not support MIDI RAW Note On/Off, Program Change, and Control Change functions. Those functions are only supported through the local I/O cards. System exclusive (SysEx) messages, including MSC, do work with a Show Control Gateway.

## Receiving MIDI

Eos Family consoles can be configured to respond to specific MIDI messages or messages matching a specific pattern. These are configured in an Event List in the Show Control Display.

Strings are configured in the MIDI String configuration display, shown below:

Note On	MIDI: 82 00 7F			Raw MIDI	Octave: 0
Note Off	C <sub>00</sub>	C#/Db <sub>01</sub>	D <sub>02</sub>		Channel: 3
Program Change	D#/Eb <sub>03</sub>	E <sub>04</sub>	F <sub>05</sub>		Velocity: 127
Control Change	F#/Gb <sub>06</sub>	G <sub>07</sub>	G#/Ab <sub>08</sub>		Velocity Threshold: 50
System	A <sub>09</sub>	A#/Bb <sub>0A</sub>	B <sub>0B</sub>		<input checked="" type="checkbox"/> Threshold at 0 = Disabled?
OK	Cancel				

## MIDI Message Types

The following MIDI messages can be received:

- [MIDI Note Events \(Note On/Note Off\)](#)
- [Program Change Events](#)
- [Control Change Events](#)
- [System Events \(MIDI Show Control\)](#)

## MIDI Note Events (Note On/Note Off)

Note On	MIDI: 82 00 7F			Raw MIDI	Octave: 0
Note Off	C <sub>00</sub>	C#/Db <sub>01</sub>	D <sub>02</sub>		Channel: 3
Program Change	D#/Eb <sub>03</sub>	E <sub>04</sub>	F <sub>05</sub>		Velocity: 127
Control Change	F#/Gb <sub>06</sub>	G <sub>07</sub>	G#/Ab <sub>08</sub>		Velocity Threshold: 50
System	A <sub>09</sub>	A#/Bb <sub>0A</sub>	B <sub>0B</sub>		<input checked="" type="checkbox"/> Threshold at 0 = Disabled?
OK	Cancel				

Note On and Note Off commands simulate activating (on) and releasing (off) a musical note. The MIDI data that is expected to be received is shown above the Note selection area, with 'N' shown where any valid number will be considered a match. This display will change as configuration options are selected. When finished configuring a Note On or Note Off event, press **{OK}** to store the event. Otherwise, press **{Cancel}** to undo the changes.

## Message Structure

Note On has a structure of 9A BC DD, where 9 represents the Note On command, A represents the channel number, B represents the octave of the note, C represents the note value, and DD represents the velocity.

Note Off has a structure of 8A BC DD, where 8 represents the Note Off command, A represents the channel number, B represents the octave of the note, C represents the note value, and DD represents the velocity.

## Options

The following options are available:

### **{Note}**

You can choose any musical note name (C-B, chromatic), or use Raw MIDI to manually enter a value.

### **{Octave}**

You can choose the specific octave for the note (octaves 0-10), or chose Any, and the console will respond when any octave of the selected note is received.

### **{Channel}**

This should match the MIDI Channel for the note command (1-16 or 0-F). If set to Any, the console will respond when any MIDI channel is sent a note command.

### **{Velocity} and {Velocity Threshold}**

In MIDI, the velocity represents the relative loudness or intensity of the note, where 1 (01) is very soft, or ppp, and 127 (7F) is very loud, or fff. (A MIDI Note On with a velocity of 0 is a special case and is treated as a Note Off command).

The Velocity setting specifies the exact velocity in the MIDI Note message that must be received for the action to be executed. Whenever the exact velocity is received, regardless of threshold, the event will fire.

The Threshold is an optional way to specify the minimum velocity that must be received for the action to be executed. In other words, the MIDI note velocity must be greater than or equal to the threshold value. If the threshold is 0, this parameter is ignored, unless the "Threshold at 0 = Disabled?" box is unchecked.

### Example:

- Velocity 127, Threshold 0, box checked – The console is looking for an incoming MIDI note with a velocity of 127 (7F). The threshold is ignored.
- Velocity 127, Threshold 0, box unchecked – The console is looking for an incoming MIDI note with a velocity that is greater than or equal to 0. The velocity is redundant, as 127 is greater than 0.
- Velocity 127, Threshold 50, box checked – The console is looking for an incoming MIDI note with a velocity that is greater than or equal to 50
- Velocity 127, Threshold 50, box unchecked – The console is looking for an incoming MIDI note with a velocity that is greater than or equal to 50 (hex 32)
- Velocity 1, Threshold 50, box checked – The console is looking for an incoming MIDI note with a velocity that is greater than or equal to 50 (hex 32). If the note with a velocity of 1 is received, the event will also fire as it matches the velocity parameter.
- Velocity 0, Threshold 50, box checked - The console is looking for an incoming MIDI note with a velocity that is greater than or equal to 50 (hex 32). If the note with a velocity of 0 is received, the event will also fire as it matches the velocity parameter.
- Velocity 0, Threshold 0, box checked – The console is looking for an incoming MIDI note that has a velocity of 0. Threshold is ignored.

## Program Change Events

The screenshot shows a configuration window for a MIDI event. On the left is a vertical menu with options: Note On, Note Off, Program Change (highlighted with a yellow border), Control Change, System, OK, and Cancel. The main area displays 'MIDI: C0 01' at the top. On the right, there is a 'Channel:' dropdown menu set to '1' and a 'Program Number:' input field set to '1'.

Program Change commands typically represent a change in the MIDI voice or instrument type that should be used for a particular MIDI channel. Similar to MIDI Note commands, the MIDI data that is expected to be received is shown in the CIA and changes as you select event parameters. When finished configuring the program change event, press **{OK}** to store the event. Otherwise, press **{Cancel}** to undo the changes.

### **Message Structure**

Program change messages have the structure CN XX, where N represents the MIDI channel number and XX represents the program number.

### **Options**

The following options are available:

#### **{Channel}**

This should match the MIDI Channel for the note command (1-16, 0-F). If set to Any, the console will respond when any MIDI channel is sent a note command.

## {Program Number}

The program number is any value between 0-127 (0-7F). Many devices will display this as 1-128 – if this is the case for your other device, subtract one from the desired program number.

## Control Change Events

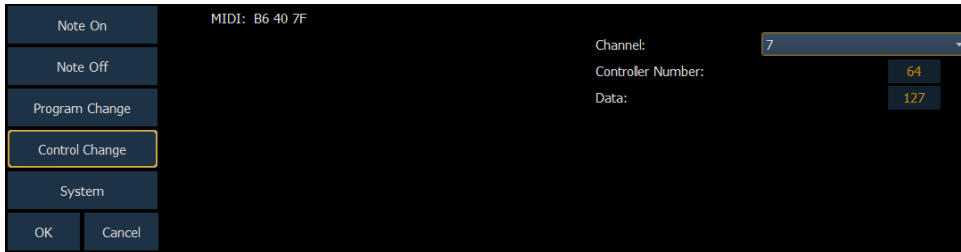

Control Change commands were designed to represent specific actions on MIDI devices, like pedals actuations and effects. For example, the Damper Pedal on a keyboard is often represented by controller number 64 (hex 40). Similar to MIDI Note commands, the MIDI data that is expected to be received is shown in the CIA and changes as you select event parameters. When finished configuring the control change event, press **{OK}** to store the event. Otherwise, press **{Cancel}** to undo the changes.

## Message Structure

Program change messages have the structure BN XX YYY, where N represents the MIDI channel number, XX represents the controller number, and YY represents the data byte.

## Options

The following options are available:

### {Channel}

This should match the MIDI Channel for the note command (1-16, 0-F). If set to Any, the console will respond when any MIDI channel is sent a note command.

### {Controller Number}

The controller number is any value between 0-127 (00-7F). Many devices will display this as 1-128 – if this is the case for your other device, subtract one from the desired controller number.

### {Data}

The data parameter is any value between 0-127 (00-7F). Many devices will display this as 1-128 – if this is the case for your other device, subtract one from the desired data byte.

## System Events (MIDI Show Control)



System commands allow you to specify specific MIDI Show Control messages that can be received and interpreted by the console. While any MIDI Show Control command that matches the configured Device ID will be executed normally, this type of event setup allows you to respond to messages sent to different device IDs, or take additional actions based on a show control command.

The MIDI data that is expected to be received is shown in the CIA and changes as you select event parameters. When finished configuring the system event, press **{OK}** to store the event. Otherwise, press **{Cancel}** to undo the changes.

## Message Structure

Please see [Hexadecimal and MIDI Show Control Formatting](#) for more information on the show control message structures.

## Options

The following options are available:

### {Commands}

- **Go, Stop, Resume** - represents triggering a cue, stopping a cue, and resuming a cue, respectively. The following fields are available:
- **Device ID** - the MIDI Show Control device ID that should respond to the message
- **List ID** - the cue list
- **ID** - the cue number
- **Set** - represents controlling a fader. The following fader targets are available:
- **Subs**
- **Grandmaster**
- **Master Fader Up** - the level of the Up fader on the master playback pair
- **Master Fader Down** - the level of the Down fader on the master playback pair

The following fields are available for the fader targets:

- **Device ID** – the MIDI Show Control device ID that should respond to the message
- **ID (subs only)** – the number of the submaster fader
- **Level** – the specified level of the fader from 0-100% (0-127 decimal, 00-7F hex)

- **Fire** – represents executing a macro. The following fields are available:
- **Device ID** – the MIDI Show Control device ID that should respond to the message
- **ID** - the macro number to be fired

## Creating a MIDI Event List and Event

Open the Show Control Display

- **[Displays]>[More SK]>[Show Control]**

Create a new Event List and choose the Network type

- **<Event> [6] [/] {Type} {Network} [Enter]**

Enable the list to respond to **{External}** sources

- **<Event> [6] [/] {External} [Enter]**

## Creating a Note On Event

Create a new event and open the MIDI String configuration screen

- **<Event> [1] [More SK] {MIDI String}**

Select the **{Note On}** type

- **{Note On}**

Select the MIDI Note value, for example, Bb (B-flat)

- **{A#/Bb}**

Select the MIDI Note octave or leave it as Any. In this example, we'll choose Any.

- **<Octave> {Any}**

Select the MIDI channel

- **<Channel> {1}**

Select the velocity

- **<Velocity> {127}**

Optionally, select the velocity threshold so that the event will be triggered if the message is above this level. To disable velocity threshold, leave it at zero.

- **<Velocity Threshold> {0}**

Press **{OK}** to save the event

- **{OK}**

Specify the action for the event

- **<Event> [1] [Macro] [1] [Enter]**

## Creating a Note Off Event

Create a new event and open the MIDI String configuration screen

- **<Event> [2] [More SK] {MIDI String}**

Select the **{Note Off}** type

- **{Note Off}**

Select the MIDI Note value, for example, Bb (B-flat)

- **{A#/Bb}**

Select the MIDI Note octave or leave it as Any. In this example, we'll choose Any.

- **<Octave> {Any}**

Select the MIDI channel

- **<Channel> {1}**

Select the velocity

- **<Velocity> {0}**

Optionally, select the velocity threshold so that the event will be triggered if the message is above this level. To disable velocity threshold, leave it at zero.

- **<Velocity Threshold> {1}**

Press **{OK}** to save the event

- **{OK}**

Specify the action for the event



- <Event> [2] [Macro] [2] [Enter]

## Creating a Program Change Event

Create a new event and open the MIDI String configuration screen

- <Event> [3] [More SK] {MIDI String}

Select the {Program Change} type

- {Program Change}

Select the MIDI channel

- <Channel> {7}

Select the program number

- <Program Number> {3}{2}

Press {OK} to save the event

- {OK}

Specify the action for the event

- <Event> [3] [Cue] [1][0] [Enter]

## Creating a Control Change Event

Create a new event and open the MIDI String configuration screen

- <Event> [4] [More SK] {MIDI String}

Select the {Control Change} type

- {Control Change}

Select the MIDI channel

- <Channel> {7}

Select the controller number

- <Controller Number> {6}{4}

Specify the data value

- <Data> {1}{2}{7}

Press {OK} to save the event

- {OK}

Specify the action for the event

- <Event> [4] [Sub] [1] {On} [Enter]

## Sending MIDI

MIDI messages can be sent from cues and subs (using {Execute}) or from a Macro.

### Cues and Submasters

After selecting a cue and pushing {Execute}, the {MIDI Raw} softkey becomes available. Notes can either be input using hexadecimal values (00 through FF) or decimal (0 through 255) values depending on the connected device. The console will default to hexadecimal format. To use decimal format, begin the MIDI string with "D" (D followed by a space).

The string will be sent any time the cue is executed or the submaster is bumped.

## **Sending a MIDI Raw String from a Cue or Submaster**

### ***Hexadecimal Format***

Select a cue or sub.

- [Cue] [1]

Press the {Execute} softkey.

- [Cue] [1] {Execute}

New softkeys will appear, press the {MIDI Raw} softkey.

- [Cue] [1] {Execute} {MIDI Raw}

Define the MIDI string, in this case we will use Hexadecimal to send a Note On command for note C3 to channel 1 with a velocity of 127.

- [Cue] [1] {Execute} {MIDI Raw} 91 3C 7F [Enter]

### ***Decimal Format***

Select a cue or sub.

- [Sub] [1]

Press the {Execute} softkey.

- [Sub] [1] {Execute}

New softkeys will appear, press the {MIDI Raw} softkey.

- [Sub] [1] {Execute} {MIDI Raw}

Define the MIDI string, in this case we will use decimal to send the same command as before - a Note On command for note C3 to channel 1 with a velocity of 127.

- [Sub] [1] {Execute} {MIDI Raw} D 145 60 127 [Enter]

## **Macros**

A {MIDI Raw} softkey is available in the macro editor display. Any text entered after the string command in the macro will be sent to all string interfaces when that macro is fired. The same syntax applies in macros as they would in cues – either hexadecimal or decimal values can be entered.

## Open Sound Control (OSC)

Open Sound Control (OSC) is a protocol that uses network communication (wired or wireless) to communicate between varying audio, video and lighting devices.

### Using OSC

An OSC command contains a method and an optional list of arguments, or additional data for a particular command.

For example:

OSC Method	Argument	Action
/eos/chan	1	[Chan] [1]
/eos/chan/1/full	None	[Chan] [1] [At] [FL]
/eos/chan/1/at	50	[Chan] [1] [At] [50]
/eos/user/5/chan	1	[Chan] [1] (as User 5)

A device that receives an OSC string will process the command as if the current user on that device typed the command.

All OSC commands directed to an Eos console must begin with **/eos/**. To direct an OSC to a particular user for a single command, the command must begin with **/eos/user/<number>/**

It is possible to set the OSC User ID via an OSC command, in which case that user ID remains as specified until changed again.

### Configuring OSC

#### *UDP and TCP*

Eos supports sending and receiving OSC through a TCP or UDP connection. The specific type used will depend on the other OSC device or software that you intend to use with Eos. You will need to check that documentation to confirm the connection types supported.

The console can be set to receive and/or transmit OSC messages. This is configured in **Setup>System>Show Control>OSC** with the **{OSC RX}** and **{OSC TX}** touchbuttons.

In addition, you must enable the **{UDP Strings & OSC}** option for the network interface you wish to use in the **ECU>Settings>Network>Interface Protocols**.

#### *TCP*

The preferred method for transmitting and receiving OSC packets is over a TCP connection. Eos will listen for incoming TCP connections on Port 3032. TCP communication still requires that **{OSC RX}** and **{OSC TX}** is enabled in the Show Control section of Setup.

In the **ECU>Settings>Network>Interface Protocols**, there is an option for changing the OSC TCP mode. By default, OSC 1.0 is selected. There are two TCP modes available – OSC 1.0 (packet-length headers) and OSC 1.1 (SLIP). Check the documentation for the OSC device you wish to use over a TCP connection to see which mode it supports.

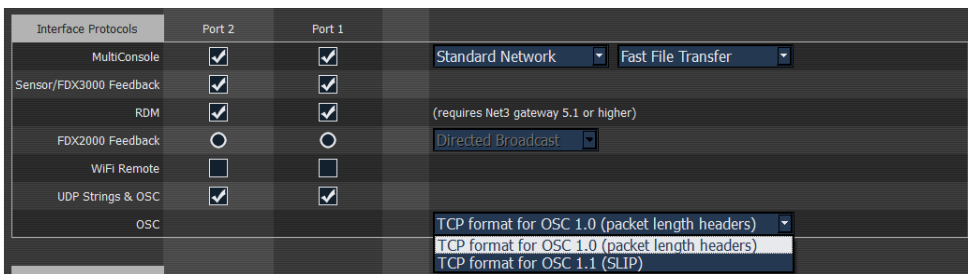

## UDP

UDP connections can be used but are not preferred, as messages may be dropped or delivered out of order. When using UDP, the appropriate IP address and ports must be configured in the Show Control section of Setup. For systems without specific networking requirements, ETC recommends UDP port assignments in the range 4703 to 4727 or 8000 and 8001.

The UDP port settings are configured in **Setup>System>Show Control**. In addition to the OSC TX (Transmit) and RX (Receive) ports, you may wish to set the OSC TX IP address to match the OSC device you are using with your Eos system so that it can receive OSC messages from the console. It is not currently possible to specify multiple IP addresses. If you are using TCP OSC, these settings can be ignored.

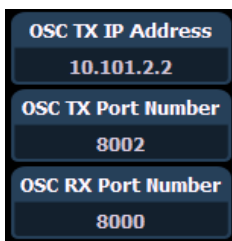

## Local

OSC commands entered in the console (via the Magic Sheet command object) that begin with **local:** will be looped back into the console.

### Example:

- `local:/eos/chan/1/at/50`

When executed, the console will send itself the OSC command to set Channel 1 to 50%.

## Ping

Once you believe that the OSC connection has been established, you can test the connection by sending a ping message to Eos and it will respond on its configured port. See [Implicit OSC Output \(on page 539\)](#) for more information.

OSC Method	Arguments	Examples/Comments
<b>Send a ping command</b>		
/eos/ping	None required, any number of arguments can be sent	/eos/ping /eos/ping="abcde" /eos/ping="abcde",4

OSC Method	Arguments	Examples/Comments
Ping response - see <a href="#">Implicit OSC Output (on page 539)</a> for more information		
/eos/out/ping	Same number of arguments that were sent	/eos/out/ping /eos/out/ping="abcde" /eos/out/ping/="abcde",4

## Supported OSC Input

All OSC commands must begin with "/eos/..." or "/eos/user/<number>/...".



**Note:** All of the command examples given can also use the "/eos/user/<number>/..." variant.

## Chan

Channel commands allow you to select Eos channels. You can directly change the channel level information in the same command, or use this as a selection tool for other controls like Absolute controls (see below).

OSC Method	Arguments	Examples/Comments
<b>Select a channel</b>		
/eos/chan	number for channel to select	/eos/chan=1
/eos/chan/<number>	number for channel level	/eos/chan/1=75 (useful for mapping to an OSC slider)
<b>Set channel intensity levels</b>		
/eos/chan/<number>/out	number for button edge: 1.0=down, 0.0=up (optional)	/eos/chan/1/out
/eos/chan/<number>/home	number for button edge: 1.0=down, 0.0=up (optional)	/eos/chan/1/home
/eos/chan/<number>/remdim	number for button edge: 1.0-0.0=down, 0.0=up (optional)	/eos/chan/1/remdim
/eos/chan/<number>/level	number for button edge: 1.0=down, 0.0=up (optional)	/eos/chan/1/level
/eos/chan/<number>/full	number for button edge: 1.0=down, 0.0=up (optional)	/eos/chan/1/full
/eos/chan/<number>/min	number for button edge: 1.0=down, 0.0=up (optional)	/eos/chan/1/min
/eos/chan/<number>/max	number for button edge: 1.0=down, 0.0=up (optional)	/eos/chan/1/max
/eos/chan/<number>/+%	number for button edge: 1.0=down, 0.0=up (optional)	/eos/chan/1/+%
/eos/chan/<number>/-%	number for button edge: 1.0=down, 0.0=up (optional)	/eos/chan/1/-%
<b>Set parameter or DMX information</b>		
/eos/chan/<number>/dmx	number for channel DMX level	/eos/chan/1/dmx=255
/eos/chan/<number>/param/<parameter>	number for parameter level	/eos/chan/1/param/pan=90 (useful for mapping to an OSC slider)
/eos/chan/<number>/param/	number for all parameter levels	/eos/chan/1/param/pan/tilt=90

OSC Method	Arguments	Examples/Comments
<parameter 1>/<parameter 2>/...	multiple numbers for each parameter level	(set channel 1 pan & tilt to 90)  /eos/chan/1/param/pan/tilt=45,90  (set channel 1 pan to 45 & tilt to 90)
/eos/chan/<number>/param/<parameter>/dmx	number for parameter DMX level	/eos/chan/1/param/pan/dmx=255
/eos/chan/<number>/param/<parameter 1>/<parameter 2>/.../ dmx	number(s) for parameter DMX level(s)	/eos/chan/1/param/pan/tilt/dmx=255
<b>Channel Output Information</b> – see <a href="#">Implicit OSC Output (on page 539)</a> for more information		
/eos/out/active/chan	String with active channels (selected) and current value from first channel	/eos/out/active/chan="1-2 [100]"

## Absolute Levels

Absolute level commands are used when there is an existing target already selected on the command line of the OSC user.

OSC Method	Arguments	Examples/Comments
<b>Set levels</b>		
/eos/at	number for the level (0-100)	/eos/at= 75 (useful for mapping to an OSC fader)
/eos/at/out	number for the button edge 1.0=down, 0.0=up (optional)	/eos/at/out
/eos/at/home	number for the button edge 1.0=down, 0.0=up (optional)	/eos/at/home
/eos/at/remdim	number for the button edge 1.0=down, 0.0=up (optional)	/eos/at/remdim
/eos/at/level	number for the button edge 1.0=down, 0.0=up (optional)	/eos/at/level
/eos/at/full	number for the button edge 1.0=down, 0.0=up (optional)	/eos/at/full
/eos/at/min	number for the button edge 1.0=down, 0.0=up (optional)	/eos/at/min
/eos/at/max	number for the button edge 1.0=down, 0.0=up (optional)	/eos/at/max
/eos/at/+%	number for the button edge 1.0=down, 0.0=up (optional)	/eos/at/+%

OSC Method	Arguments	Examples/Comments
/eos/at/-%	number for the button edge 1.0=down, 0.0=up (optional)	/eos/at/-%
<b>Set parameter or DMX information</b>		
/eos/at/dmx	number for the DMX level	/eos/at/dmx/128 (useful for mapping to an OSC slider)
/eos/param/<parameter>	number for the level	/eos/param/pan=270 (useful for mapping to an OSC slider)
/eos/param/<parameter>/out	number for the button edge 1.0=down, 0.0=up (optional)	/eos/param/pan/out
/eos/param/<parameter>/home	number for the button edge 1.0=down, 0.0=up (optional)	/eos/param/pan/home
/eos/param/<parameter>/level	number for the button edge 1.0=down, 0.0=up (optional)	/eos/param/pan/level
/eos/param/<parameter>/full	number for the button edge 1.0=down, 0.0=up (optional)	/eos/param/pan/full
/eos/param/<parameter>/min	number for the button edge 1.0=down, 0.0=up (optional)	/eos/param/pan/min
/eos/param/<parameter>/max	number for the button edge 1.0=down, 0.0=up (optional)	/eos/param/pan/max
/eos/param/<parameter>/+%	number for the button edge 1.0=down, 0.0=up (optional)	/eos/param/pan/+%
/eos/param/<parameter>/-%	number for the button edge 1.0=down, 0.0=up (optional)	/eos/param/pan/-%
/eos/param/<parameter 1>/ <parameter 2>	number for all parameter levels  multiple numbers for each parameter level	/eos/param/pan/tilt=45 (set pan & tilt to 45)  /eos/param/pan/tilt=45,90 (set pan to 45 & tilt to 90)

## Color

OSC Method	Arguments	Examples/Comments
/eos/color/hs	Argument 1: Hue (0.0-360.0) Argument 2: Saturation (0.0-100.0)	/eos/color/hs=330.0, 75.0 (pink color with 75% saturation)
/eos/color/hsxy	Argument 1: X (0.0-1.0) Argument 2: Y (0.0-1.0)	For simulating the Hue/Saturation wheel in a 2D XY graph where bottom-left corner is (0.0, 0.0) and top-right corner it (1.0, 1.0) /eos/color.hsxy=0.82, 0.31 (pink color with 75% saturation)
/eos/color/rgb	Argument 1: Red (0.0-	/eos/color/rgb=1.0, 0.25, 0.63 (pink color with 75%

OSC Method	Arguments	Examples/Comments
	1.0) Argument 2: Green (0.0-1.0) Argument 3: Blue (0.0-1.0)	saturation)
/eos/color/xy	Argument 1: x (0.0-1.0) Argument 2: y (0.0-1.0)	For setting (x, y) chromaticity point in the CIE 1931 xyY color space /eos/color/xy=0.464, 0.254 (pink color with 75% saturation)
/eos/color/xyz	Argument 1: X Argument 2: Y Argument 3: Z	For setting (X, Y, Z) color point in XYZ color space /eos/color/xyz=0.851, 0.466, 0.516 (pink color with 75% saturation)

## Wheel

A wheel can be used to adjust channel levels and parameters.

OSC Method	Arguments	Examples/Comments
/eos/pantilt/xy	Argument 1: X (0.0-1.0) Argument 2: Y (0.0-1.0)	For 2D Pan/Tilt graph where bottom-left corner is (0.0, 0.0) and top-right corner if (1.0, 1.0)
<b>Level Wheel</b>		
/eos/wheel/level	number for wheel ticks for the specified wheel mode (positive or negative)	/eos/wheel/level=1.0 (increase value)  /eos/wheel/level=-1.0 (decrease value)  /eos/wheel/level=4.0 (increase value rapidly)  (defaults to Coarse mode, but wheel mode can be changed with the /eos/wheel command below)
/eos/wheel	number for wheel mode: 0=coarse, 1=fine	/eos/wheel=1.0
<b>Wheel Output</b> - see <a href="#">Implicit OSC Output</a> for more information		
/eos/out/wheel	number for current wheel mode: 0=coarse, 1=fine	/eos/out/wheel=1.0
<b>Indexed Wheels</b> - see <a href="#">Active Parameters</a>		
/eos/wheel/<index>/level	number for wheel ticks for the specified wheel mode (positive or negative)	/eos/wheel/2/level=1.0 (increase value)  /eos/wheel/2/level=-1.0 (decrease value)  /eos/wheel/2/level=4.0 (increase value rapidly)



OSC Method	Arguments	Examples/Comments
		(defaults to Coarse mode, but wheel mode can be changed with the /eos/wheel command below)
/eos/wheel/<index>	number for wheel mode: 0=coarse, 1=fine	/eos/wheel=1.0
<b>Parameter wheels and encoders</b>		
/eos/wheel/<parameter>	number for wheel ticks (positive or negative)	/eos/wheel/pan=1.0
/eos/wheel/<parameter 1>/<parameter 2>/...	number for wheel ticks (positive or negative)	/eos/wheel/pan/tilt=1.0
/eos/wheel/fine/<parameter>	number for fine wheel ticks (positive or negative)	/eos/wheel/fine/pan=1.0
/eos/wheel/fine/<parameter 1>/<parameter 2>/...	number for fine wheel ticks (positive or negative)	/eos/wheel/fine/pan/tilt=1.0
/eos/wheel/course/<parameter>	number for coarse wheel ticks (positive or negative)	/eos/wheel/course/pan=1.0
/eos/wheel/course/<parameter 1>/<parameter 2>/...	number for coarse wheel ticks (positive or negative)	/eos/wheel/course/pan/tilt=1.0

## Switch



**Note:** *Switch* is a variant of *Wheel* with the added functionality of continuously repeating wheel ticks until a subsequent OSC switch command sets the wheel ticks to zero.

This may be used to continuously tick a wheel while a button is held down, for example. The expected argument range is -1.0 to 1.0, which affects the tick rate accordingly, but can be a smaller or larger range for more subtle or rapid movement.

OSC Method	Arguments	Examples/Comments
<b>Switch/Wheel Level</b>		
/eos/switch/level	X level wheel ticks	
/eos/switch	Set OSC wheel mode	0 = Course, 1 = Fine
<b>Switch Mode Output</b> – see <a href="#">Implicit OSC Output (on page 539)</a> for more information		
/eos/out/switch	Current OSC wheel mode	/eos/out/switch=1.0
<b>Swich/Wheel and Encoder Levels</b>		
/eos/switch/<parameter>	X OSC wheel mode ticks for specified parameter (ex: pan)	
/eos/switch/<parameter 1>/<parameter 2>/...	X OSC wheel mode ticks for specified parameters (ex: red, green, blue)	
/eos/switch/fine/<parameter>	X fine wheel ticks for specified parameter (ex: pan)	
/eos/switch/fine/<parameter 1>/<parameter 2>/...	X fine wheel mode ticks for specified parameters (ex: red, green, blue)	
/eos/switch/course/<parameter>	X course wheel ticks for specified parameter (ex: pan)	

OSC Method	Arguments	Examples/Comments
/eos/switch/course/<parameter 1>/ <parameter 2>/...	X course wheel mode ticks for specified parameters (ex: red, green, blue)	

## Active Parameters



**Note:** The parameter <index> is a 1-based index referencing the list of current parameters for the selected channel(s). Eos will send the parameter name and current value for each active parameter, so that the wheels on your OSC-enabled device may be labeled appropriately.

OSC Method	Arguments	Examples/Comments
<b>Wheel</b>		
/eos/active/wheel/<index>	number of wheel ticks for the specific wheel mode (positive or negative)	/eos/active/wheel/1=1.0 (increase value)  /eos/active/wheel/1=-1.0 (decrease value)  /eos/active/wheel/1=4.0 (increase value rapidly)  (defaults to Coarse mode, but wheel mode can be changed with the /eos/wheel command)
/eos/active/wheel/fine/<index>	number of fine wheel ticks (positive or negative)	/eos/active/wheel/fine/1=1.0
/eos/active/wheel/course/<index>	number of coarse wheel ticks (positive or negative)	/eos/active/wheel/course/ 1=1.0
<b>Switch</b>		
/eos/active/switch/<index>	number of wheel ticks for the specific switch mode (positive or negative)	/eos/active/switch/1=1.0 (increase value)  /eos/active/switch/1=-1.0 (decrease value)  /eos/active/switch/1=4.0 (increase value rapidly)  /eos/active/switch/1=0.25 (increase value slowly)  (defaults to Coarse mode, but wheel mode can be changed)

OSC Method	Arguments	Examples/Comments
		with the /eos/ switch command)
/eos/active/switch/fine/<index>	number of fine wheel ticks (positive or negative)	/eos/active/switch/fine/1=1.0
/eos/active/switch/coarse/<index>	number of coarse wheel ticks (positive or negative)	/eos/active/switch/coarse/ 1=1.0
<b>Active Wheel Data Sent by Eos</b> - see <a href="#">Implicit OSC Output (on page 539)</a> for more information		
/eos/out/active/wheel<number>	2 arguments: String with parameter name and current value from first channel	/eos/out/active/wheel/1="Intensity", 100

## Subscribe to Specific Parameters

Once subscribed, Eos will reply with an OSC packet per parameter as they change.

For Example:

- /eos/out/param/pan

See [Implicit OSC Output \(on page 539\)](#) for more information.

OSC Method	Arguments	Examples/Comments
/eos/subscribe/param/<parameter>	1=subscribe, 0=u- unsubscribe	/eos/subscribe/param/red=1
/eos/subscribe/param/<parameter 1>/<- parameter 2>/...	1=subscribe, 0=u- unsubscribe	/eos/subscribe/param/pan/tilt=1

## Direct Selects

OSC direct selects are virtual buttons and are mapped separately than direct selects visible on the console. To use direct selects, you must first send one of the direct select creation commands. Direct selects are mapped as a single target type.



**Note:** Eos will send the description and button labels for all OSC direct selects. See [Implicit OSC Output](#) for more information.

OSC Method	Arguments	Examples/Comments
<b>Direct Select Creation</b>		
/eos/ds/<index>/<target type>/ <button count>		/eos/ds/1/chan/10 (create OSC direct select bank #1 with 10 channel buttons)  /eos/ds/2/group/25 (create OSC direct select bank #2 with 25 group but- tons)
/eos/ds/<index>/<target type>/ flexi/<button count>		/eos/ds/1/chan/flexi/10 (create OSC direct select bank #1 with 10 channel buttons, in flexi mode)

OSC Method	Arguments	Examples/Comments
/eos/ds/<index>/<target type>/ <page number>/<button count>		/eos/ds/1/chan/3/10 (create OSC direct select bank #1 with 10 channel buttons on page 3)  Can also be used to quick jump to a specific page
/eos/ds/<index>/<target type>/ flexi/<page number>/<button count>		/eos/ds/1/chan/flexi/3/10 (create OSC direct select bank #1 with 10 channel buttons on page 3, in flexi mode)  Can also be used to quick jump to a specific page
<b>Direct Select Paging</b>		
/eos/ds/<index>/page/<delta>	number for page delta	/eos/ds/1/page/1 (page down by 1)  /eos/ds/1/page/-1 (page up by 1)  /eos/ds/1/page/10 (page down by 10)
<b>Using Direct Selects</b>		
/eos/ds/<index>/<button index>	number for button edge: 1.0=down, 0.0=up (optional)	/eos/ds/1/1=1.0 (press first button of OSC direct select bank #1)  /eos/ds/1/1=0.0 (release first button of OSC direct select bank #1)
<b>Direct Select Information sent by Eos</b> – see <a href="#">Implicit OSC Output (on page 539)</a> for more information		
/eos/out/ds/<index>	String argument containing descriptive text for direct select at <index>: target name, page number, mode	/eos/out/ds/1/1="Channels [1]"  /eos/ds/1/1="Groups [1 – Flexi]"
/eos/out/ds/<index>/<button index>	String argument containing target description (name/number)	/eos/out/ds/1/1="Cyc [1]"



**Note:** <index> is a 1-based index of any number of OSC direct select banks you wish to create.

<target type> may be one of the following:

- Chan
- Group
- Macro
- Sub
- Preset
- IP (intensity palette)
- FP (focus palette)
- CP (color palette)
- BP (beam palette)
- MS (Magic Sheet)
- Curve
- Snap (snapshot)
- FX (Effects)
- Pixmap

## Fader Banks

Fader banks share fader mapping with Eos, but since an OSC Fader Bank can have any number of faders per page, the paging will be different. Like Direct Selects, you must first send one of the OSC Fader Bank creation commands before the fader pages will work. Faders will be mapped to the same fader number as Eos.

Example:

- Create an OSC fader bank with 10 faders per page `/eos/fader/1/config/10`
- OSC Fader 1/1 is the same as console fader 1/1.
- OSC Fader 2/1 (Fader 11) is the same as console fader 2/1.

Another example:

- Create an OSC fader bank with 5 faders per page `/eos/fader/1/config/5`
- OSC Fader 2/1 (Fader 6) is the same as console fader 1/6 (Fader 6)
- OSC Fader 3/1 (Fader 11) is the same as console fader 2/1 (Fader 11)



**Note:** `<index>` is a 1-based index of any number of discrete sets of OSC fader banks you wish to create. Eos will send the description and fader labels for all OSC fader banks. See [Implicit OSC Output \(on page 539\)](#) for more information.



**Note:** Use an `<index>` of zero to reference the master fader.

OSC Method	Arguments	Examples/Comments
<b>Fader Page Creation</b>		
<code>/eos/fader/&lt;index&gt;/config/&lt;fader count&gt;</code>	none	<code>/eos/fader/1/config/10</code> (create OSC fader bank #1 with 10 faders)
<code>/eos/fader/&lt;index&gt;/config/&lt;page number&gt;/&lt;fader count&gt;</code>	none	<code>/eos/fader/1/config/2/10</code> (create OSC fader bank #1 with 10 faders on page 2) Can also be used to quick jump to a specific page
<b>Fader Controls</b>		
<code>/eos/fader/&lt;index&gt;/config/&lt;page number&gt;/&lt;fader count&gt;</code>	none	<code>/eos/fader/1/config/2/10</code> Jump to a specific fader page (OSC Fader Map 1, Page 2 of 10 faders)
<code>/eos/fader/&lt;index&gt;/page/&lt;delta&gt;</code>	none	<code>/eos/fader/1/page/1</code> (page down by 1)  <code>/eos/fader/1/page/-1</code> (page up by 1)  <code>/eos/fader/1/page/10</code> (page down by 10)
<code>/eos/fader/&lt;index&gt;/&lt;fader index&gt;</code>	floating point number to set sub percent to	<code>/eos/fader/1/2=0.75</code> (set the second fader in OSC fader bank #1 to 75%)
<code>/eos/fader/&lt;index&gt;/&lt;fader index&gt;/load</code>	none	<code>/eos/fader/1/2/load</code>
<code>/eos/fader/&lt;index&gt;/&lt;fader index&gt;/unload</code>	none	<code>/eos/fader/1/2/unload</code>
<code>/eos/fader/&lt;index&gt;/&lt;fader index&gt;/</code>	none	<code>/eos/fader/1/2/stop</code>

OSC Method	Arguments	Examples/Comments
stop		
/eos/fader/<index>/<fader index>/fire	none	/eos/fader/1/2/fire
/eos/fader/<index>/<fader index>/out	none	/eos/fader/1/2/out
/eos/fader/<index>/<fader index>/home	none	/eos/fader/1/2/home
/eos/fader/<index>/<fader index>/min	none	/eos/fader/1/2/min
/eos/fader/<index>/<fader index>/max	none	/eos/fader/1/2/max
/eos/fader/<index>/<fader index>/full	none	/eos/fader/1/2/full
/eos/fader/<index>/<fader index>/level	none	/eos/fader/1/2/level
/eos/fader/<index>/<fader index>/+%	none	/eos/fader/1/2/+%
/eos/fader/<index>/<fader index>/-%	none	/eos/fader/1/2/-%
<b>Fader Status Information</b> – see <a href="#">Implicit OSC Output (on page 539)</a> for more information		
/eos/out/fader/<index>/<fader>/name	String argument with fader label for OSC fader	/eos/out/fader/1/1="S 1 Label" Sub 1 with a label "Label" /eos/out/fader/1/2="IP 1 Label" IP 1 fader labeled "Label"
/eos/out/fader/<index>/<fader>/name	Floating point argument for fader percent (0.0-1.0)	/eos/out/fader/1/1=0.75 /eos/out/fader/1/2=0.0
/eos/out/fader/<index>	String argument, descriptive text for OSC fader bank at index	/eos/fader/1="1"

## Key



**Note:** For a list of supported key names, see [Eos OSC Keys](#).

OSC Method	Arguments	Examples/Comments
/eos/key/<name>	number for button edge: 1.0=down, 0.0=up (optional)	/eos/key/select active=1.0 (press [Select Active] but- ton)  /eos/key/select active=0.0 (release [Select Active] but- ton)  /eos/key/go 0

OSC Method	Arguments	Examples/Comments
		(press & release [Go] button)



**Note:** For the slash key, use a backslash /eos/key/

## Address

OSC Method	Arguments	Examples/Comments
<b>Selection</b>		
/eos/addr	number for address to select	/eos/addr=513
<b>Set Levels (Parks address while on the OSC command line)</b>		
/eos/addr/<address>	number for level to set address to (0-100)	/eos/addr/513=100 (useful for mapping to an OSC slider)
/eos/addr/<address>/dmx	number for DMX level to set address to (0-255)	/eos/addr/513/dmx=255 (useful for mapping to an OSC slider)

## Magic Sheet

OSC Method	Arguments	Examples/Comments
/eos/ms	number of the magic sheet to open	/eos/ms=1
/eos/ms/<ms number>	number of the magic sheet view to open (optional)	/eos/ms/1=2

## Group

Selects and controls channels in groups.



**Note:** Same syntax and behavior as Chan.

OSC Method	Arguments	Examples/Comments
/eos/group	number for group to select	/eos/group=1
/eos/group/<number>	number for channel level	/eos/group/1=75
/eos/group/<number>/out	number for button edge: 1.0=down, 0.0=up (optional)	/eos/group/1/out
/eos/group/<number>/home	number for button edge: 1.0=down, 0.0=up (optional)	/eos/group/1/home
/eos/group/<number>/level	number for button edge: 1.0=down, 0.0=up (optional)	/eos/group/1/level
/eos/group/<number>/full	number for button edge: 1.0=down, 0.0=up (optional)	/eos/group/1/full

OSC Method	Arguments	Examples/Comments
/eos/group/<number>/min	number for button edge: 1.0=down, 0.0=up (optional)	/eos/group/1/min
/eos/group/<number>/max	number for button edge: 1.0=down, 0.0=up (optional)	/eos/group/1/max
/eos/group/<number>/+ %	number for button edge: 1.0=down, 0.0=up (optional)	/eos/group/1/+ %
/eos/group/<number>/- %	number for button edge: 1.0=down, 0.0=up (optional)	/eos/group/1/- %
/eos/group/<number>/dmx	number for dmx level 1.0=down, 0.0=up (optional)	/eos/group/1/dmx=127
/eos/group/<number>/param/ <parameter>	number for parameter level	/eos/group/1/param/pan=90
/eos/group/<number>/param/ <parameter 1>/<parameter 2>/...	number(s) for parameter levels	/eos/group/1/param/pan/tilt=90,75
/eos/group/<number>/param/ <parameter>/dmx	number for parameter dmx level	/eos/group/1/param/pan=255
/eos/group/<number>/param/ <parameter 1>/<parameter 2>/.../ dmx	number(s) for dmx parameter levels	/eos/group/1/param/pan/tilt/dmx=255

## Macro

Selects and fires (executes) macros

OSC Method	Arguments	Examples/Comments
/eos/macro	number for macro to select	/eos/macro=1
/eos/macro/fire	number for macro to run	/eos/macro/fire=1
/eos/macro/<number>/fire	number for button edge: 1.0=down, 0.0=up (optional)	/eos/macro/1/fire=1.0

## Submaster

OSC Method	Arguments	Examples/Comments
<b>Select Submaster</b>		
/eos/sub	number for sub to select	/eos/sub=1
<b>Control Submaster</b>		
/eos/sub/<number>	floating point number to set sub percent to	/eos/sub/1=0.75 (useful for mapping to an OSC slider)
/eos/sub/<number>/out	number for button edge: 1.0=down,	/eos/sub/1/out



OSC Method	Arguments	Examples/Comments
	0.0=up (optional)	
/eos/sub/<number>/home	number for button edge: 1.0=down, 0.0=up (optional)	/eos/sub/home
/eos/sub/<number>/level	number for button edge: 1.0=down, 0.0=up (optional)	/eos/sub/1/level
/eos/sub/<number>/full	number for button edge: 1.0=down, 0.0=up (optional)	/eos/sub/1/full
/eos/sub/<number>/min	number for button edge: 1.0=down, 0.0=up (optional)	/eos/sub/1/min
/eos/sub/<number>/max	number for button edge: 1.0=down, 0.0=up (optional)	/eos/sub/max
/eos/sub/fire	number for sub to bump	/eos/sub/fire=1
/eos/sub/<number>/fire	number for button edge: 1.0=down, 0.0=up (optional)	/eos/sub/1/fire=1.0 (bump sub 1 on)  /eos/sub/1/fire=0.0 (bump sub 1 off)

### **Preset**

OSC Method	Arguments	Examples/Comments
<b>Select Preset</b>		
/eos/preset	number of preset to select	/eos/preset=1
<b>Recall Preset</b>		
/eos/preset/fire	number of preset to recall	/eos/preset/fire=1
/eos/preset/<number>/fire	number for button edge: 1.0=down, 0.0=up (optional)	/eos/preset/1/fire

### **Intensity Palette**

OSC Method	Arguments	Examples/Comments
<b>Select Intensity Palette</b>		
/eos/ip	number of intensity palette to select	/eos/ip=1
<b>Recall Intensity Palette</b>		
/eos/ip/fire	number of intensity palette to recall	/eos/ip/fire=1
/eos/ip/<number>/fire	number for button edge: 1.0=down, 0.0=up (optional)	/eos/ip/1/fire

### **Focus Palette**

OSC Method	Arguments	Examples/Comments
<b>Select Focus Palette</b>		
/eos/fp	number of focus palette to select	/eos/fp=1
<b>Recall Focus Palette</b>		
/eos/fp/fire	number of focus palette to recall	/eos/fp/fire=1
/eos/fp/<number>/fire	number for button edge: 1.0=down, 0.0=up (optional)	/eos/fp/1/fire

## Color Palette

OSC Method	Arguments	Examples/Comments
<b>Select Color Palette</b>		
/eos/cp	number of color palette to select	/eos/cp=1
<b>Recall Color Palette</b>		
/eos/cp/fire	number of color palette to recall	/eos/cp/fire=1
/eos/cp/<number>/fire	number for button edge: 1.0=down, 0.0=up (optional)	/eos/cp/1/fire

## Beam Palette

OSC Method	Arguments	Examples/Comments
<b>Select Beam Palette</b>		
/eos/bp	number of beam palette to select	/eos/bp=1
<b>Recall Beam Palette</b>		
/eos/bp/fire	number of beam palette to recall	/eos/bp/fire=1
/eos/bp/<number>/fire	number for button edge: 1.0=down, 0.0=up (optional)	/eos/bp/1/fire

## Cue

OSC Method	Arguments	Examples/Comments
<b>Select Cue or Cue Parts</b>		
/eos/cue	Number of cue to select	/eos/cue=1.5
/eos/cue/<list number>	Number of cue to select (in the specified cue list)	/eos/cue/1=1.5
/eos/cue/<list number>/<cue number>	Number of cue part to select (in the specified cue list and cue number)	/eos/cue/1/1.5=2
<b>Run Cues</b>		
/eos/cue/fire	Number of cue to run	/eos/cue/fire=1
/eos/cue/<cue number>/fire	Number for button edge: 1.0=down, 0.0=up (optional)	/eos/cue/1.5/fire
/eos/cue/<list number>/<cue number>/fire	Number for button edge: 1.0=down, 0.0=up (optional)	/eos/cue/1/1.5/fire
/eos/cue/<list number>/<cue number>/<part number>/fire	Number for button edge: 1.0=down, 0.0=up (optional)	/eos/cue/1/1.5/2/fire
<b>Cue Information Sent by Eos</b> – see <a href="#">Implicit OSC Output (on page 539)</a> for more information		
/eos/out/active/cue/<list>/<cue>	Float argument with percent complete 0.0=started, 1.0 complete	/eos/out/active/cue/5/1=0.75  Updated once per second
/eos/out/active/cue	Float argument with percent complete 0.0=started, 1.0 complete	/eos/out/active/cue=0.75  Updated once per second

OSC Method	Arguments	Examples/Comments
/eos/out/active/cue/text	String argument with descriptive text about active cue	/eos/out/active/cue/text="1/1 Label 5.00 100%"
/eos/out/pending/cue/<list>/<cue>	None	/eos/out/pending/cue/5/1.5
/eos/out/pending/cue/<list>/<cue>/text	String argument with descriptive text about active cue	/eos/out/pending/cue/text="1/1.5 Label 5.00"

## Cue List Banks



**Note:** <index> is a 1-based index of any number of OSC cue list banks you wish to create. Eos will send the cue list label and cue information for all OSC cue list banks. See [Explicit OSC Output](#) for more information.

OSC Method	Arguments	Examples/Comments
/eos/cuelist/<index>/config/<cue list number>/<num prev cues>/<num pending cues>		/eos/cuelist/1/2/3/6 (create OSC cue list bank #1 for cue list 2, showing 3 previous cues, the current cue, and 6 pending cues)  NOTE: set <cue list number> to zero to follow the current cue list
/eos/cuelist/<index>/config/<cue list number>/<num prev cues>/<num pending cues>/<offset>		/eos/cuelist/1/2/3/6/10 (create OSC cue list bank #1 for cue list 2, showing 3 previous cues, the current cue, and 6 pending cues, starting at offset 10 into the cue list) offset is a zero-based index into the entire cue list, where each cue counts as one item and each cue part counts as one item  NOTE: set <cue list number> to zero to follow the current cue list
/eos/cuelist/<index>/page/<delta>		/eos/cuelist/1/page/1 (page OSC cue list bank down 1 row)  /eos/cuelist/1/page/-1 (page OSC cue list bank up 1 row)  /eos/cuelist/1/page/0 (jump back to the current cue and follow it)
/eos/cuelist/<index>/select/<cue number>		/eos/cuelist/1/select/100.4 (jump to cue 100.4)

## Softkey



**Note:** <index> is 1-based index into the softkey list. There are 6 softkeys and 2 pages, so valid <index> numbers are 1-12.

OSC Method	Arguments	Examples/Comments
/eos/softkey/<index>	number for button edge: 1.0=down, 0.0-0=up (optional)	/eos/softkey/1=1.0 (press 1st softkey)  /eos/softkey/1=0.0 (release 1st softkey)

## Other Targets - Selection

OSC Method	Arguments	Examples/Comments
/eos/curve	number of curve to select	/eos/curve=1
/eos/fx	number of effect to select	/eos/fx=1
/eos/snap	number of snapshot to recall	/eos/snap=1
/eos/pixmap	number of pixel map to select	/eos/pixmap=1

## User

Use this command to set the OSC user ID. User 0 represents the background user (used in Background macros and elsewhere). User -1 represents the current user on the console receiving OSC commands.

OSC Method	Arguments	Examples/Comments
/eos/user	number for OSC user ID	/eos/user=1 (set OSC user ID to 1)  /eos/user=-1 (set OSC user to match con-sole)  /eos/user=0 (set OSC user as background user)
<b>Current User ID Output</b> – see <a href="#">Implicit OSC Output (on page 539)</a> for more information		
/eos/out/user	number for current OSC user ID	/eos/out/user=1

## Command Line

Command line instructions can be sent directly. String substitution with arguments is also allowed. To add a substitution, add %1 (or %2, %3, etc...) where the number given is the argument number where the actual value should be found.

### Example:

- **"Chan %1 At FL", 101** - Eos will substitute 101 in place of %1, meaning the command is interpreted as Chan 101 At FL
- **"Chan %1 At %2", 75, 50** - Eos will substitute 75 in place of %1 (as it is the first argument), and 50 in place of %2. The command is interpreted as Chan 75 At 50.

OSC Method	Arguments	Examples/Comments
<b>Direct command line entry</b>		
/eos/cmd	string with command line text	/eos/cmd="Chan 1 At 75" (unterminated command)  /eos/cmd="Chan 1 At 75#" (terminated command)  /eos/cmd="Chan 1 At 75 Enter" (terminated command)

OSC Method	Arguments	Examples/Comments
/eos/cmd	in-line command line	/eos/cmd="Chan 1 At
	arguments	%1#", 75
		(results in command line
		"Chan 1 At 75#"
		/eos/cmd="Chan %1 At
		%2#", 1, 75
/eos/cmd/<text>/<text>/<text>/...	in-line command line arguments (optional)	/eos/cmd/Chan/1/At/75 /eos/cmd/Chan/%1/At/ %2#=1, 75
<b>Clear command line each time</b>		
/eos/newcmd	Same behavior as /eos/ cmd, but it resets the command line first	
<b>Direct event entry</b>		
/eos/event	Same behavior as /eos/ cmd, but treated as con- sole event	
/eos/newevent	Same behavior as /eos/ cmd, but it resets the command line first	
<b>Command Line Output</b> - see <a href="#">Implicit OSC Output (on the facing page)</a> for more information		
/eos/out/user/<number>/cmd	String with current command line text for current console user	
/eos/out/cmd	String with current command line text	

## Other

OSC Method	Arguments	Examples/Comments
/eos/reset		clears any active switches resets all persistent OSC set- tings (like OSC user ID & wheel modes) send ALL implicit OSC out- put commands

## Explicit OSC Output

OSC outputs exactly like Serial String outputs, but the string must start with an OSC address (ex: "/ device/fader").

Optionally, you may add arguments by adding "=" to the string, followed by a comma-delimited list of arguments.

For example, to send a Playback fire command to a ColorSource AV console:

/cs/playback/1/fire=1 would send "/cs/playback/1/fire" as the command and 1 as the first (and only) integer argument

Numeric arguments with a decimal are treated as 32-bit floating point numbers. Numeric arguments without a decimal are treated as 32-bit integer numbers. Non-numeric arguments are treated as strings.

Examples:

- `"/device/command"` No arguments
- `"/device/command=1"` One integer argument
- `"/device/command=1.5"` One floating point argument
- `"/device/command=1.5,3.0"` Two floating point arguments
- `"/device/command=1.5,3.0,text"` Two floating point arguments, one string argument

## Implicit OSC Output

When UDP transmit is enabled, certain OSC commands are sent out as appropriate. These events are typically generated as the target changes or in response to user input.

### Command Lines

- `"/eos/out/user/<number>/cmd"`, <string argument with current command line text for the current console user>
- `"/eos/out/cmd"`, <string argument with current command line text>

### OSC Settings

- `"/eos/out/user"`, <integer argument with current OSC user ID>
- `"/eos/out/wheel"`, <float argument with current OSC wheel mode: 0.0=Coarse, 1.0=Fine>
- `"/eos/out/switch"`, <float argument with current OSC switch mode: 0.0=Coarse, 1.0=Fine>

### Active Channels and Parameters

- `"/eos/out/active/chan"`, <string argument with active channels and current value from the 1st channel>
- `"/eos/out/active/wheel/<number>`, <string argument with parameter name and current value from the 1st channel><integer argument category>
  - Null / Unassigned = 0
  - Intensity = 1
  - Focus = 2
  - Color = 3
  - Image = 4
  - Form = 5
  - Shutter = 6



**Note:** This allows you to create a ML Controls style interface via OSC. For example, on the OSC-enabled device, setup 10 wheels (`/eos/active/wheel/<1-10>`) with matching labels. If using in conjunction with `"/eos/active/switch/<number>`", you should still use `"/eos/out/active/wheel/<number>`" to display feedback for that switch.

---

### Active Cue



**Note:** Updated once per second.

---

- `"/eos/out/active/cue/<cue list number>/<cue number>`", <float argument with percent complete (0.0-1.0)>
- `"/eos/out/active/cue"`, <float argument with percent complete (0.0-1.0)>
- `"/eos/out/active/cue/text"`, <string argument with descriptive text about the active cue, ex: `"1/ 2.3 Label 0:05 75%"`>
- `"/eos/out/pending/cue/<cue list number>/<cue number>`"

- `"/eos/out/pending/cue/text"`, <string argument with descriptive text about the pending cue, ex: `"1/2.4 Label 0:30">`

### **OSC Direct Select Banks**

- `"/eos/out/ds/<index>"`, <string argument with descriptive text for the OSC direct select at <index>: target name, page number, and mode>>
- `"/eos/out/ds/<index>/<button index>"`, <string argument with button label for OSC direct select at <index> for button <button index>>

### **OSC Fader Banks**

- `"/eos/out/fader/<index>"`, <string argument with descriptive text for the OSC fader bank at <index>>
- `"/eos/out/fader/<index>/<fader index>/name"`, <string argument with fader label for OSC fader bank at <index> for fader <fader index>>
- `"/eos/fader/<index>/<fader index>"`, <floating point number for fader percent: 0.0-1.0>



**Note:** *Eos will delay sending fader levels for faders that have been moved via OSC commands for 3 seconds. If you move a fader on an OSC remote control, Eos will send the actual fader level 3 seconds later.*

---

### **OSC Show Control Events**

Show control events are fired as the console executes the corresponding action, much like MIDI Show Control output events.

- `"/eos/out/event/cue/<cue list number>/<cue number>/fire"`
- `"/eos/out/event/cue/<cue list number>/<cue number>/stop"`
- `"/eos/out/event/sub/<sub number>"`, <integer argument, 0=Bump Off, 1=Bump On>
- `"/eos/out/event/macro/<macro number>"`
- `"/eos/out/event/relay/<relay number>/<group number>"`, <integer argument, 0=On, 1=Off>
- `"/eos/out/event"` (used for time code learn)

### **Show File Information**

- `"/eos/out/show/name"`, <string argument with show title>
- `"/eos/out/event/show/saved"`, <string argument with file path>
- `"/eos/out/event/show/loaded"`, <string argument with file path>
- `"/eos/out/event/show/cleared"`

### **Miscellaneous Console Events**

- `"/eos/out/event/state"`, <integer argument, 0=Blind, 1=Live>



**Note:** *When Eos receives the command `"/eos/ping"` it will reply with `"/eos/out/ping"`. You may optionally add any number of arguments and Eos will reply with the same arguments. This may be useful for testing latency.*

---



## Eos Family Show Control Capabilities



**Note:** Net3 Show Control Gateway has been abbreviated to SC GW for this table.

	Hardware MIDI Connections	MIDI Show Control (MSC)	MIDI Time Code (MTC)	MIDI Notes	SMPTE
Eos Titanium (Ti)	Yes, In/Out	Local In/Out Also via SC GW	Local In Only Also via SC GW	Local Out Only Also via SC GW	Via SC GW In Only
Eos Console	No	Via SC GW	Via SC GW In Only	Via SC GW Out Only	Via SC GW In Only
Eos RPU	No	Via SC GW	Via SC GW In Only	Via SC GW Out Only	Via SC GW In Only
Gio	Yes, In/Out	Local In/Out Also via SC GW	Local In Only Also via SC GW	Local Out Only Also via SC GW	Via SC GW In Only
Gio @ 5	No	Via SC GW	Via SC GW In Only	Via SC GW Out Only	Via SC GW In Only
Ion	Yes, In/Out	Local In/Out Also via SC GW	Local In Only Also via SC GW	Local Out Only Also via SC GW	Via SC GW In Only
Ion RPU & Eos Family RPU3	Yes, In/Out	Local In/Out Also via SC GW Or Programming Wing (Win7 only)	Local In Only Also via SC GW Or Programming Wing (Win7 only)	Local Out Only Also via SC GW Or Programming Wing (Win7 only)	Via SC GW In Only
Element	Yes, In/Out	Local In/Out Also via SC GW	Local In Only Also via SC GW	Local Out Only Also via SC GW	Via SC GW In Only
ETCnomad (PC/Mac) and ETCnomad Puck	No	Via SC GW Or Programming Wing	Via SC GW In Only Or Programming	Via SC GW Out Only Or Programming	Via SC GW In Only

	Hardware MIDI Connections	MIDI Show Control (MSC)	MIDI Time Code (MTC)	MIDI Notes	SMPTE
			Wing	Wing	
Eos Programming Wing	Yes, In/Out	Local In/Out Also via SC GW	Local In Only Also via SC GW	Local Out Only Also via SC GW	Via SC GW In Only
Net3 Show Control GW	Yes In/Out/Thru	Yes In/Out	Yes In Only	Yes Out Only	Yes In Only
Net3 I/O GW	n/a	n/a	n/a		n/a

	Analog	Contact Closure	Relay Out	RS-232	UDP Strings
Eos Titanium (Ti)	Via I/O GW	4 closures, others via I/O	1 local SPDT, others via I/O	Via I/O GW	Rx & Tx
Eos Console	Via I/O GW	Via I/O GW	Via I/O GW	Via I/O GW	Rx & Tx
Eos RPU	Via I/O GW	Via I/O GW	Via I/O GW	Via I/O GW	Rx & Tx
Gio	Via I/O GW	4 closures, others via I/O	1 local SPDT, others via I/O	Via I/O GW	Rx & Tx
Gio @ 5	Via I/O GW	4 closures, others via I/O	1 local SPDT, others via I/O	Via I/O GW	Rx & Tx
Ion	Via I/O GW	4 closures, others via I/O	1 local SPDT, others via I/O	Via I/O GW*	Rx & Tx
Ion RPU & Eos Family RPU3	Via I/O GW	4 closures, others via I/O	1 local SPDT, others via I/O	Via I/O GW*	Rx & Tx
ETCnomad (PC/Mac) and ETCnomad Puck	Via I/O GW	Via I/O GW	Via I/O GW	Via I/O GW	Rx & Tx
Eos Programming Wing	Via I/O GW	4 closures, others via I/O	1 local SPDT, others via I/O	Via I/O GW	n/a
Element	Via I/O GW	4 closures, others via I/O	1 local SPDT, others via I/O	Via I/O GW	Rx & Tx
Net3 Show Control GW	n/a	n/a	n/a	n/a	n/a
Net3 I/O GW	Yes 24 shared circuits- analog or digital		Yes 16 SPDT relays	Yes	n/a

\*Ion consoles that have a DVI splitter and any Ion RPU have a local RS-232 port that is not enabled. For questions, please contact ETC Technical Services. See [Help from ETC Technical Services \(on page 1\)](#) to find the office closest to you.

## Advanced OSC

### OSC List Convention

The OSC List convention is used to send OSC commands that may exceed 512 bytes of data.

To add an OSC List of items to an OSC Command, append the OSC Command Path with `/list/<index>/<count>`, where `<index>` is the zero-based index offset into the entire list and `<total>` is the total number of elements in the entire list.

#### Example:

- OSC List that fits in a single packet

```
/eos/out/get/curve/901/list/0/3 = <uint32: 0> <string: 0DF9082C-4A39-40FC-9532-6C3AC01BC6B5> <string: IES Square>
```

- OSC List that spans 2 packets

```
/eos/out/get/curve/901/list/0/3 = <uint32: 0> <string: 0DF9082C-4A39-40FC-9532-6C3AC01BC6B5> /eos/out/get/curve/901/list/2/3 = <string: IES Square>
```

### OSC UID

UIDs uniquely identify each show data target, and are preserved in the show file. This allows you to synchronize with a show file once and then again at a later time, even if changes were made in between.

UIDs will be specified as strings in the following format:

```
XXXXXXXX-XXXX-XXXX-XXXX-XXXXXXXXXXXX
```

#### Example:

- BOBAEOA0-3BBE-4004-888B-F61CA125D0B0

### OSC Numbers and Number Ranges

OSC Arguments that contains numbers or number ranges will be sent as follows:

Eos target numbers will be sent as 32-bit integers when possible. If they are not whole numbers (ex: Cue 1.23), they will be sent as strings.

#### Example:

- 10
- "1.23"

When a range numbers contains 2 or more consecutive whole numbers, they will be represented as strings in the following format:

```
X-Y
```

#### Example:

- "1-100"

## OSC Gel

Gels will be represented as strings in the following format:

<Gel Manufacturer Abbreviation><Gel Number>

### Example:

"AP1150" (Apollo 1150)  
"G101" (Gam 101)  
"L2" (Lee 2)  
"R80" (Rosco 80)  
"SG1" (Rosco Super Gel 1)  
"E194" (Rosco E Color 194)  
"T12" (TokyoBS Poly Color 12)

## Integrating Your App with Eos

There are four steps to integrating an OSC App with Eos.

Those steps are covered in the following topics:

- [Integrating Your App with Eos: Step 1 – Request Eos Software Version \(below\)](#)
- [Integrating Your App with Eos: Step 2 - Synchronize \(below\)](#)
- [Integrating Your App with Eos: Step 3 – Staying in Sync \(on page 546\)](#)
- [Integrating Your App with Eos: Step 4 – Modifying Eos Show Data \(on page 548\)](#)

### **Integrating Your App with Eos: Step 1 – Request Eos Software Version**

Request the version number of the Eos by sending the following command: `/eos/get/version`.

Eos will reply with:

`/eos/out/get/version = <string: X.X.X.X.X>`

### Example:

- `<string: 2.3.0.1.0.111>`



**Note:** *This is useful if future versions of Eos software change the way OSC integration commands are handled.*

### **Integrating Your App with Eos: Step 2 - Synchronize**

Request the number of items of a specific type of data you are interested with one of the following commands:

- `/eos/get/patch/count`
- `/eos/get/cuelist/count`
- `/eos/get/cue/<cue list number>/count`
- `/eos/get/group/count`
- `/eos/get/group/displayed/count`
- `/eos/get/macro/count`
- `/eos/get/sub/count`
- `/eos/get/preset/count`

- /eos/get/ip/count (ip = Intensity Palette)
- /eos/get/fp/count (fp = Focus Palette)
- /eos/get/cp/count (cp = Color Palette)
- /eos/get/bp/count (bp = Beam Palette)
- /eos/get/curve/count
- /eos/get/fx/count (fx = Effect)
- /eos/get/snap/count (snap = Snapshot)
- /eos/get/pixmap/count
- /eos/get/ms/count (ms = Magic Sheet)

Eos will reply with the matching command:

- /eos/out/get/patch/count = <uint32: count>
- /eos/out/get/cuelist/count = <uint32: count>
- /eos/out/get/cue/<cue list number>/count = <uint32: count>
- /eos/out/get/group/count = <uint32: count>
- /eos/out/get/group/displayed/count = <uint32: count>
- /eos/out/get/macro/count = <uint32: count>
- /eos/out/get/sub/count = <uint32: count>
- /eos/out/get/preset /count = <uint32: count>
- /eos/out/get/ip/count = <uint32: count>
- /eos/out/get/fp/count = <uint32: count>
- /eos/out/get/cp/count = <uint32: count>
- /eos/out/get/bp/count = <uint32: count>
- /eos/out/get/curve/count = <uint32: count>
- /eos/out/get/fx/count = <uint32: count>
- /eos/out/get/snap/count = <uint32: count>
- /eos/out/get/pixmap/count = <uint32: count>
- /eos/out/get/ms/count = <uint32: count>

Now you can request detailed information for each item form index 0 to count as follows:

- /eos/get/patch/index/<index number>
- /eos/get/cuelist/index/<index number>
- /eos/get/cue/<cue list number>/index/<index number>
- /eos/get/group/index/<index number>
- /eos/get/group/displayed/index/<index number>
- /eos/get/macro/index/<index number>
- /eos/get/sub/index/<index number>
- /eos/get/preset/index/<index number>
- /eos/get/ip/index/<index number>
- /eos/get/fp/index/<index number>
- /eos/get/cp/index/<index number>
- /eos/get/bp/index/<index number>
- /eos/get/curve/index/<index number>
- /eos/get/fx/index/<index number>
- /eos/get/snap/index/<index number>
- /eos/get/pixmap/index/<index number>
- /eos/get/ms/index/<index number>

Eos will reply with the matching command: (detailed OSC arguments for each data type listed below)

- /eos/out/get/patch/<channel number>/<part number>/list/<list index>/<list count> = <uint32: list index> <string: UID> ...

- `/eos/out/get/cuelist/<cue list number>/list/<list index>/<list count>` = <uint32: list index> <string: UID> ...
- `/eos/out/get/cue/<cue list number>/<cue number>/<cue part number>/list/<list index>/<list count>` = <uint32: list index> <string: UID> ...
- `/eos/out/get/group/<group number>/list/<list index>/<list count>` = <uint32: list index> <string: UID> ...
- `/eos/out/get/group/displayed/<group number>/list/<list index>/<list count>` = <uint32: list index> <string: UID> ...
- `/eos/get/macro/<macro number>/list/<list index>/<list count>` = <uint32: list index> <string: UID> ...
- `/eos/get/sub/<sub number>/list/<list index>/<list count>` = <uint32: list index> <string: UID> ...
- `/eos/get/preset/<preset number>/list/<list index>/<list count>` = <uint32: list index> <string: UID> ...
- `/eos/get/ip/<ip number>/list/<list index>/<list count>` = <uint32: list index> <string: UID> ...
- `/eos/get/fp/<fp number>/list/<list index>/<list count>` = <uint32: list index> <string: UID> ...
- `/eos/get/cp/<cp number>/list/<list index>/<list count>` = <uint32: list index> <string: UID> ...
- `/eos/get/bp/<bp number>/list/<list index>/<list count>` = <uint32: list index> <string: UID> ...
- `/eos/get/curve/<curve number>/list/<list index>/<list count>` = <uint32: list index> <string: UID> ...
- `/eos/get/fx/<fx number>/list/<list index>/<list count>` = <uint32: list index> <string: UID> ...
- `/eos/get/snap/<snap number>/list/<list index>/<list count>` = <uint32: list index> <string: UID> ...
- `/eos/get/pixmap/<pixmap number>/list/<list index>/<list count>` = <uint32: list index> <string: UID> ...
- `/eos/get/ms/<ms number>/list/<list index>/<list count>` = <uint32: list index> <string: UID> ...

### ***Integrating Your App with Eos: Step 3 – Staying in Sync***

Your app can now request all of the show data from Eos, but if a user is editing show data, your app would become out of sync. The solution to this is to subscribe to Eos show data changes with the following command: `/eos/subscribe` = <uint32: X> (where 0=unsubscribe, 1=subscribe)

While subscribed, Eos will send the following commands when Eos show data changes:

In the reply, the first argument will be a sequence number, followed by a list of the targets that changed. The targets are specified OSC Numbers and/or OSC Number Ranges

- `/eos/out/notify/patch/list/<list index>/<list count>` = <uint32: sequence number>, ...
- `/eos/out/notify/cuelist/list/<list index>/<list count>` = <uint32: sequence number>, ...
- `/eos/out/notify/cue/<cue list number>/list/<list index>/<list count>` = <uint32: sequence number>, ...
- `/eos/out/notify/group/list/<list index>/<list count>` = <uint32: sequence number>, ...
- `/eos/out/notify/macro/list/<list index>/<list count>` = <uint32: sequence number>, ...
- `/eos/out/notify/sub/list/<list index>/<list count>` = <uint32: sequence number>, ...
- `/eos/out/notify/preset/list/<list index>/<list count>` = <uint32: sequence number>, ...
- `/eos/out/notify/ip/list/<list index>/<list count>` = <uint32: sequence number>, ...
- `/eos/out/notify/fp/list/<list index>/<list count>` = <uint32: sequence number>, ...
- `/eos/out/notify/cp/list/<list index>/<list count>` = <uint32: sequence number>, ...

- /eos/out/notify/bp/list/<list index>/<list count> = <uint32: sequence number>, ...
- /eos/out/notify/curve/list/<list index>/<list count> = <uint32: sequence number>, ...
- /eos/out/notify/fx/list/<list index>/<list count> = <uint32: sequence number>, ...
- /eos/out/notify/snap/list/<list index>/<list count> = <uint32: sequence number>, ...
- /eos/out/notify/pixmap/list/<list index>/<list count> = <uint32: sequence number>, ...
- /eos/out/notify/ms/list/<list index>/<list count> = <uint32: sequence number>, ...

When your app receives a notification that Eos show data has changed, you should then request detailed information about the modified show data. You may request detailed show data via target number or UID. (From the initial sync, you should be able to build a mapping of each type of show data to correlate target number with UID)

Request detailed show data information via target number:

- /eos/get/patch/<channel number> (Eos returns ALL parts)
- /eos/get/patch/<channel number>/<part number> (specific channel part)
- /eos/get/cuelist/<cue list number>
- /eos/get/cue/<cue list number>/<cue number> (Eos returns base cue and ALL parts)
- /eos/get/cue/<cue list number>/<cue number>/0 (base cue)
- /eos/get/cue/<cue list number>/<cue number>/<cue part number> (specific cue part)
- /eos/get/group/<group number>
- /eos/get/macro/<macro number>
- /eos/get/sub/<sub number>
- /eos/get/preset/<preset number>
- /eos/get/ip/<ip number>
- /eos/get/fp/<fp number>
- /eos/get/cp/<cp number>
- /eos/get/bp/<bp number>
- /eos/get/curve/<curve number>
- /eos/get/fx/<fx number>
- /eos/get/snap/<snap number>
- /eos/get/pixmap/<pixmap number>
- /eos/get/ms/<ms number>

Request detailed show data information via UID:

- /eos/get/patch/uid/<UID>
- /eos/get/cuelist/uid/<UID>
- /eos/get/cue/uid/<UID>
- /eos/get/group/uid/<UID>
- /eos/get/group/displayed/uid/<UID>
- /eos/get/macro/uid/<UID>
- /eos/get/sub/uid/<UID>
- /eos/get/preset/uid/<UID>
- /eos/get/ip/uid/<UID>
- /eos/get/fp/uid/<UID>
- /eos/get/cp/uid/<UID>
- /eos/get/bp/uid/<UID>
- /eos/get/curve/uid/<UID>
- /eos/get/fx/uid/<UID>
- /eos/get/snap/uid/<UID>
- /eos/get/pixmap/uid/<UID>
- /eos/get/ms/uid/<UID>

Eos will reply with the same command as if the detailed information were requested via index as shown in [Step 2](#).

## **Integrating Your App with Eos: Step 4 – Modifying Eos Show Data**

You can modify Eos show data. Typically you should build Eos command lines and send them with the command `/eos/cmd` or `/eos/newcmd`.

However, you can use the following convenience commands for editing the most common show data attributes:

- `/eos/set/patch/<channel number>/label` = <string: text> (include part number in the path when necessary)
- `/eos/set/patch/<channel number>/text1` = <string: text>
- `/eos/set/patch/<channel number>/text2` = <string: text>
- `/eos/set/patch/<channel number>/text3` = <string: text>
- `/eos/set/patch/<channel number>/text4` = <string: text>
- `/eos/set/patch/<channel number>/text5` = <string: text>
- `/eos/set/patch/<channel number>/text6` = <string: text>
- `/eos/set/patch/<channel number>/text7` = <string: text>
- `/eos/set/patch/<channel number>/text8` = <string: text>
- `/eos/set/patch/<channel number>/text9` = <string: text>
- `/eos/set/patch/<channel number>/text10` = <string: text>
- `/eos/set/patch/<channel number>/notes` = <string: text>
- `/eos/set/patch/<channel number>/gel` = <string: text>
- `/eos/set/cuelist/<cue list number>/label` = <string: text>
- `/eos/set/cue/<cue list number>/<cue number>/label` = <string: text> (base data)
- `/eos/set/cue/<cue list number>/<cue number>/<cue part number>/label` = <string: text> (part data)
- `/eos/set/group/<group number>/label` = <string: text>
- `/eos/set/macro/<macro number>/label` = <string: text>
- `/eos/set/sub/<sub number>/label` = <string: text>
- `/eos/set/preset/<preset number>/label` = <string: text>
- `/eos/set/ip/<ip number>/label` = <string: text>
- `/eos/set/fp/<fp number>/label` = <string: text>
- `/eos/set/cp/<cp number>/label` = <string: text>
- `/eos/set/bp/<bp number>/label` = <string: text>
- `/eos/set/curve/<curve number>/label` = <string: text>
- `/eos/set/fx/<fx number>/label` = <string: text>
- `/eos/set/snap/<snap number>/label` = <string: text>
- `/eos/set/pixmap/<pixmap number>/label` = <string: text>
- `/eos/set/ms/<ms number>/label` = <string: text>

### **Detailed Information Packet Contents**



**Note:** < index > is only valid when detailed information is requested via /index (for performance reasons)

---

*PATCH (1 OF 2):*

```
/eos/out/get/patch/<channel number>/<part number>/list/<list index>/<list count> =  
<uint32: index>
```



<string: OSC UID>  
<string: label>  
<string: fixture manufacturer>  
<string: fixture model>  
<uint32: address>  
<uint32: address of intensity parameter> (useful for monitoring streaming output to see live levels)  
<uint32: current level>  
<string: OSC Gel>  
<string: text 1>  
<string: text 2>  
<string: text 3>  
<string: text 4>  
<string: text 5>  
<string: text 6>  
<string: text 7>  
<string: text 8>  
<string: text 9>  
<string: text 10>  
<uint32: part count>

**Example:**

```
/eos/out/get/patch/1/1/list/0/20 = 0, "00000000-0000-0000-0000-000000000000",  
"My Fixture Label", "ETC_Fixtures", "S4_LED_S2_Lustr_Direct", 1, 1, 0, "R80", "My_  
Text_One", "My_Text_Two", "My_Text_Three", "My_Text_Four", "My_Text_Five",  
"My_Text_Six", "My_Text_Seven", "My_Text_Eight", "My_Text_Nine", "My_Text_  
Ten", 1
```

*PATCH (2 OF 2):*

```
/eos/out/get/patch/<channel number>/<part number>/notes =  
<uint32: index>  
<string: OSC UID>  
<string: notes>
```

**Example:**

```
/eos/out/get/patch/1/1/notes = 0, "00000000-0000-0000-0000-000000000000", "My  
Notes"
```

*CUELIST (1 OF 2):*

```
/eos/out/get/cuelist/<cue list number>/list/<list index>/<list count> = <uint32: index>  
<string: OSC UID>  
<string: label>  
<string: playback mode>  
<string: fader mode> <bool: independent>  
<bool: HTP>  
<bool: assert>  
<bool: block>  
<bool: background>  
<bool: solo mode>  
<uint32: timecode list>  
<bool: OOS sync>
```

**Example:**

```
/eos/out/get/cuelist/1/list/0/13 = 0, "00000000-0000-0000-0000-000000000000", "My  
Cue List One Label", "Master", "Proportional", True, False, True, False, False, False,  
1, False
```

*CUELIST (2 OF 2):*

```
/eos/out/get/cuelist/<cue list number>/links/list/<list index>/<list count> =  
<uint32: index>  
<string: OSC UID>  
<OSC Number Range: linked cue lists list>
```

**Example:**

```
/eos/out/get/cuelist/1/links/list/0/3 = 0, "00000000-0000-0000-0000-000000000000",  
2
```

*CUE (1 OF 4):*

```
/eos/out/get/cue/<cue list number>/<cue number>/<cue part number>/list/<list index>/<list  
count> =  
<uint32: index>  
<string: OSC UID>  
<string: label>  
<uint32: up time duration (ms)>  
<uint32: up time delay (ms)>  
<uint32: down time duration (ms)>
```

<uint32: down time delay (ms)>  
 <uint32: focus time duration (ms)>  
 <uint32: focus time delay (ms)>  
 <uint32: color time duration (ms)>  
 <uint32: color time delay (ms)>  
 <uint32: beam time duration (ms)>  
 <uint32: beam time delay (ms)>  
 <bool: preheat>  
 <OSC Number: curve>  
 <uint32: rate>  
 <string: mark>  
 <string: block>  
 <string: assert>  
 <OSC Number: link> or <string: link> (string if links to a separate cue list)  
 <uint32: follow time (ms)>  
 <uint32: hang time (ms)>  
 <bool: all fade>  
 <uint32: loop>  
 <bool: solo>  
 <string: timecode>  
 <uint32: part count> (not including base cue, so zero for cues with no parts)  
 <notes>  
 <scene (text)>  
 <bool: scene end>  
 <cue part index> (-1 if not a part of a cue, the index otherwise)

**Example:**

```

/eos/out/get/cue/1/1/0/list/0/27 = 0, "00000000-0000-0000-0000-000000000000",
  "My Cue One Label", 0, 0, 0, 0, 0, 0, 6000, 0, 0, 0, True, 901, 90, "", "B", "A", 3, 0,
  0, True, 1, False, "00:00:00:02", 0
  
```

**CUE (2 OF 4):**

```

/eos/out/get/cue/<cue list number>/<cue number>/<cue part number>/fx/list/<list index>/<list
count> =
<uint32: index>
<string: OSC UID>
<OSC Number Range: effect list>
  
```

**Example:**

```
/eos/out/get/cue/1/1/0/fx/list/0/3 = 0, "00000000-0000-0000-0000-000000000000",  
"1-3"
```

*CUE (3 OF 4):*

```
/eos/out/get/cue/<cue list number>/<cue number>/<cue part number>/links/list/<list  
index>/<list count> =
```

<uint32: index>

<string: OSC UID>

<OSC Number Range: linked cue lists list>

**Example:**

```
/eos/out/get/cue/1/1/0/links/list/0/3 = 0, "00000000-0000-0000-0000-000000000000",  
2
```

*CUE (4 OF 4):*

```
/eos/out/get/cue/<cue list number>/<cue number>/<cue part number>/actions/list/<list  
index>/<list count> =
```

<uint32: index>

<string: OSC UID>

<string: ext link action>

**Example:**

```
/eos/out/get/cue/1/1/0/actions/list/0/3 = 0, "00000000-0000-0000-0000-  
000000000000", "Chan 90 At Full"
```

*GROUP (1 OF 2):*

```
/eos/get/group/<group number>/list/<list index>/<list count> =
```

<uint32: index>

<string: OSC UID>

<string: label>

**Example:**

```
/eos/out/get/group/1.2/list/0/3 = 0, "00000000-0000-0000-0000-000000000000", "My  
Group One Point Two Label"
```

*GROUP (2 OF 2):*

```
/eos/get/group/<group number>/channels/list/<list index>/<list count> = <uint32: index>
```

<string: OSC UID>

<string: label>

**Example:**

```
/eos/out/get/group/1.2/channels/list/0/5 = 0, "00000000-0000-0000-0000-000000000000", "1-100", 200, 300
```

*MACRO (1 OF 2):*

```
/eos/get/macro/<macro number>/list/<list index>/<list count> =
```

<uint32: index>

<string: OSC UID>

<string: label>

<string: mode>

**Example:**

```
/eos/out/get/macro/1/list/0/4 = 0, "00000000-0000-0000-0000-000000000000", "My Macro One Label", ""
```

*MACRO (2 OF 2):*

```
/eos/get/macro/<macro number>/text/list/<list index>/<list count> =
```

<uint32: index>

<string: OSC UID>

<string: command text> (split into multiple packets via OSC List convention if necessary)

**Example:**

```
/eos/out/get/macro/1/text/list/0/3 = 0, "00000000-0000-0000-0000-000000000000", "Go_To_Cue Out Time 0"
```

*SUB (1 OF 2):*

```
/eos/get/sub/<sub number>/list/<list index>/<list count> =
```

<uint32: index>

<string: OSC UID>

<string: label>

<string: mode>

<string: fader mode>

<bool: HTP>

<bool: exclusive>

<bool: background>

<bool: restore>

<string: priority>

<string: up time>  
<string: dwell time>  
<string: down time>

**Example:**

`/eos/out/get/sub/3/list/0/13 = 0, "00000000-0000-0000-0000-000000000000", "My Sub Three Label", "Additive", "Proportional", True, False, True, False, "", "0", "Man", "0"`

*SUB (2 OF 2):*

`/eos/get/sub/<sub number>/fx/list/<list index>/<list count> =`  
<uint32: index>  
<string: OSC UID>  
<OSC Number Range: effect list>

**Example:**

`/eos/out/get/sub/3/fx/list/0/3 = 0, "00000000-0000-0000-0000-000000000000", 10`

*PRESET (1 OF 4):*

`/eos/get/preset/<preset number>/list/<list index>/<list count> =`  
<uint32: index>  
<string: OSC UID>  
<string: label>  
<bool: absolute>  
<bool: locked>

**Example:**

`/eos/out/get/preset/10/list/0/5 = 0, "00000000-0000-0000-0000-000000000000", "My Preset Ten Label", True, True`

*PRESET (2 OF 4):*

`/eos/get/preset/<preset number>/channels/list/<list index>/<list count> =`  
<uint32: index>  
<string: OSC UID>  
<OSC Number Range: channel list>

**Example:**

`/eos/out/get/preset/10/channels/list/0/3 = 0, "00000000-0000-0000-0000-000000000000", "1-5"`

*PRESET (3 OF 4):*

```
/eos/get/preset/<preset number>/byType/list/<list index>/<list count> =  
<uint32: index>  
<string: OSC UID>  
<OSC Number Range: by type channel list>
```

**Example:**

```
/eos/out/get/preset/10/byType/list/0/2 = 0, "00000000-0000-0000-0000-  
000000000000"
```

*PRESET (4 OF 4):*

```
/eos/get/preset/<preset number>/fx/list/<list index>/<list count> =  
<uint32: index>  
<string: OSC UID>  
<OSC Number Range: effect list>
```

**Example:**

```
/eos/out/get/preset/10/fx/list/0/0 = 0, "00000000-0000-0000-0000-000000000000"
```

*PALETTE (1 OF 3):*

```
/eos/get/<palette type>/<palette number>/list/<list index>/<list count> =  
<uint32: index>  
<string: OSC UID>  
<string: label>  
<bool: absolute>  
<bool: locked>
```

**Example:**

```
/eos/out/get/ip/1/list/0/5 = 0, "00000000-0000-0000-0000-000000000000", "My IP  
One Label", False, False
```

*PALETTE (2 OF 3):*

```
/eos/get/<palette type>/<palette number>/channels/list/<list index>/<list count> =  
<uint32: index>  
<string: OSC UID>  
<OSC Number Range: channel list>
```

**Example:**

```
/eos/out/get/ip/1/channels/list/0/3 = 0, "00000000-0000-0000-0000-000000000000",
1-5(s)
```

*PALETTE (3 OF 3):*

```
/eos/get/<palette type>/<palette number>/byType/list/<list index>/<list count> =
<uint32: index>
<string: OSC UID>
<OSC Number Range: by type channel list>
```

**Example:**

```
/eos/out/get/ip/1/byType/list/0/2 = 0, "00000000-0000-0000-0000-000000000000"
```

*CURVE (1 OF 1):*

```
/eos/get/curve/<curve number>/list/<list index>/<list count> =
<uint32: index>
<string: OSC UID>
<string: label>
```

**Example:**

```
/eos/out/get/curve/901/list/0/2 = 0, "00000000-0000-0000-0000-000000000000", "IES
Square"
```

*EFFECT (1 OF 1):*

```
/eos/get/fx/<fx number>/list/<list index>/<list count> =
<uint32: index>
<string: OSC UID>
<string: label>
<string: effect type>
<string: entry>
<string: exit>
<string: duration>
<uint32: scale>
```

**Example:**

```
/eos/out/get/fx/901/list/0/8 = 0, "00000000-0000-0000-0000-000000000000",
"Circle", "Focus", "Immediate", "Immediate", "Infinite", 25
```



*SNAPSHOT (1 OF 1):*

`/eos/get/snap/<snap number>/list/<list index>/<list count> =`

<uint32: index>

<string: OSC UID>

<string: label>

**Example:**

`/eos/out/get/snap/1/list/0/2 = 0, "00000000-0000-0000-0000-000000000000", "My Snap One Label"`

*PIXEL MAP (1 OF 2):*

`/eos/get/pixmap/<pixmap number>/list/<list index>/<list count> =`

<uint32: index>

<string: OSC UID>

<string: label>

<uint32: server channel>

<string: interface>

<uint32: width>

<uint32: height>

<uint32: pixel count>

<uint32: fixture count>

**Example:**

`/eos/out/get/pixmap/1/list/0/9 = 0, "00000000-0000-0000-0000-000000000000", "My Pixmap One Label", 100, "sACN", 32, 32, 1024, 1024`

*PIXEL MAP (2 OF 2):*

`/eos/get/pixmap/<pixmap number>/channels/list/<list index>/<list count> =`

<uint32: index>

<string: OSC UID>

<OSC Number Range: layer channel list>

**Example:**

`/eos/out/get/pixmap/1/channels/list/0/3 = 0, "00000000-0000-0000-0000-000000000000", "101-105"`

*MAGIC SHEET (1 OF 1):*

`/eos/get/ms/<ms number>/list/<list index>/<list count> =`

<uint32: index>

<string: OSC UID>

<string: label>

### **Example:**

```
/eos/out/get/ms/1/list/0/2 = 0, "00000000-0000-0000-0000-000000000000", "My MS  
One Label"
```

## **OSC Troubleshooting**

In Eos, open the Diagnostics tab (Hold **[Tab]** and press **[9][9]**). Click **{Incoming OSC}** to enable logging of incoming OSC commands and **{Outgoing OSC}** to log outgoing OSC commands.

To verify that basic OSC communication is working, you may send the command **/eos/ping** and Eos will reply with **/eos/out/ping**. You may also add any number of arguments to the command, for example, if you want to measure latency.

## Eos OSC Keys

The following is a list of the supported key names for use with OSC:

/eos/key/	Internal Eos Command
(	CHAN_SUBGROUP_BEGIN
)	CHAN_SUBGROUP_END
+	PLUS
-	MINUS
.	POINT
\	SLASH
:	COLON
@	AT
+%	PLUS10
-%	MINUS10
0	0
1	1
2	2
3	3
4	4
5	5
6	6
7	7
8	8
9	9
100_channel_display	100_CHANNEL_DISPLAY
_last	SLOTLAST
_next	SLOTNEXT
a	DIMMER_A
about	ABOUT
absolute	ABSOLUTE_EFFECT
acn_device_disconnect	ACN_DEVICE_DISCONNECT
action	ACTION
add_favorite	PATCH_ADD_FAVORITE
addfiltercat	ADD_FILTER_CAT
addfilterparam	ADD_FILTER_PARAM
additive	ADDITIVE
address	ADDRESS
after_sunrise	RTC_AFTER_SUNRISE
after_sunset	RTC_AFTER_SUNSET
all	UPDATE_ALL
all_speed	ALL_SPEED_PARAMS
all_workspaces	ALL_WORKSPACES
allfade	ALLFADE
allnps	ALL_NIPS
alternate	ALTERNATE
always_absolute	ABSOLUTE_PALETTE

/eos/key/	Internal Eos Command
analog	ANALOG
analog_input	ANALOG_INPUT
and	AND
apply	EFFECT_PATTERN_APPLY
arrow_down	ARROW_DOWN
arrow_left	ARROW_LEFT
arrow_right	ARROW_RIGHT
arrow_up	ARROW_UP
artnet	ARTNET_INTERFACE
ascii_case	ASCII_CASE
ascii_delims	ASCII_DELIMS
ascii_levels	ASCII_LEVELS
ascii_manuf	ASCII_MANUF
assert	ASSERT
asserttime	ASSERT_TIME
at	AT_TEXT
attach	ATTACH_DEVICE
attribute_mode	CIAPATCH_ATTRIB_MODE
attributes	EFFECT_ATTRIBUTES
attributewheel	ATTRIBUTE_WHEEL
auto_dim	COLOR_FADE_AUTO_BRIGHTNESS
autoblock_clean	AUTOBLOCK_CLEANUP
automark	AUTO_MARK
automark_off	AUTOMARK_OFF
autoplayback	AUTOPLAYBACK
autosave	AUTOSAVE
autosavetime	AUTOSAVE_TIME
avab/udp	AVAB_INTERFACE
axis	AXIS
b	DIMMER_B
back	BACK
background	BACKGROUND_FADER
background_mode	MACRO_BACKGROUND
backspace	BACKSPACE
backtime	BACK_TIME
beam	BEAM_CAT
beam_palette	BEAM_PALETTE
before_sunrise	RTC_BEFORE_SUNRISE
before_sunset	RTC_BEFORE_SUNSET
blackout	BLACKOUT_BUTTON
blackout_enable	BLACKOUT_ENABLE
blind	PREVIEW
block	BLOCK
bounce	BOUNCE
bpm	BPM

/eos/key/	Internal Eos Command
break_nested	BREAK_NESTED
break_nested_off	BREAK_NESTED_OFF
build	BUILD
bump	SC_BUMP
bump_1	BUMP01
bump_10	BUMP10
bump_2	BUMP02
bump_3	BUMP03
bump_4	BUMP04
bump_5	BUMP05
bump_6	BUMP06
bump_7	BUMP07
bump_8	BUMP08
bump_9	BUMP09
by_type	BY_TYPE_PALETTE
calibrate	CALIBRATE
can't_be	CANT_BE
can_be	CAN_BE
cancel_command	CANCEL
capture	CAPTURE
cascade_entry	CASCADE_ENTRY
cascade_exit	CASCADE_EXIT
center	FAN_CENTER
chan	CHAN
chan_per_group	FAN_CHANNELS_PER_GROUP
channel_filter	CHANNEL_FILTER
channelfader	CHANNEL_FADER
channelparam	CHANNEL_PARAM
check	CHANNEL_CHECK
cia_softkey1	CIA_SOFTKEY1
cia_softkey2	CIA_SOFTKEY2
cia_softkey3	CIA_SOFTKEY3
cia_softkey4	CIA_SOFTKEY4
cia_softkey5	CIA_SOFTKEY5
cia_softkey6	CIA_SOFTKEY6
cie_xyy	COLOR_FADE_CIE_XYY
cleanup	CLEANUP_PALETTE
clear	CLEAR_DATA
clear_all	CLEAR_ALL
clear_all_tabs	CLEAR_ALL_TABS
clear_all_visible_tabs	CLEAR_ALL_VISIBLE_TABS
clear_all_workspace_tabs	CLEAR_ALL_WORKSPACE_TABS
clear_calibration	CLEAR_CALIBRATION
clear_cmd	CLEAR
clear_cmdline	RESET_COMMAND_LINE

/eos/key/	Internal Eos Command
clear_effect	EFFECT_PATTERN_CLEAR
clear_errors	DIMRACK_CLR_ERRS
clear_filters	CLEAR_FILTER_COMMAND
clear_hold_color_point_origin	CLEAR_HOLD_COLOR_POINT_ORIGIN
clear_midi	CLEAR_MIDI
clear_module	SS_CLEAR
clear_patch	CLEAR_PATCH
clear_rig_check	DIMRACK_CLR_RIG_CHK
clear_show	CLEAR_SHOW
clear_smpte	CLEAR_SMPTE
clear_subs_1to1_	CLEAR_SUBS_1TO1
clear_targets	CLEAR_TARGETS
clear_text	CLEAR_TEXT
close	OFFSET_CIA_CLOSE
close_fader_controls	CLOSE_FADER_CONTROLS
cluster	FAN_CLUSTER
cmy	COLOR_FADE_CMY
color	COLOR_CAT
color_effect	COLOR_EFFECT
color_fade_times	COLOR_FADE_TIMES
color_fade_type	COLOR_FADE_TYPE
color_gel	COLOR_GEL
color_gel_match_hybrid	COLOR_GEL_MATCH_HYBRID
color_gel_match_spectrum	COLOR_GEL_MATCH_SPECTRUM
color_palette	COLOR_PALETTE
color_path	COLOR_PATH
color_scrub	COLOR_SCRUB
color_scrub_replay	COLOR_SCRUB_REPLAY
column_move_left	COLUMN_MOVE_LEFT
column_move_right	COLUMN_MOVE_RIGHT
column_resize_larger	COLUMN_RESIZE_LARGER
column_resize_smaller	COLUMN_RESIZE_SMALLER
command_history	OPENCMDHISTORY
commandline_on_psd	CMDLNONPSD
complete	GOTO_CUE_COMPLETE
confirm_command	CONFIRMED
continuous_run	CONTINUOUS_RUN
control	CONTROL_CAT
control_cat	CONTROL_FILTER
copy_to	COPY_TO
create_type	NEW_EFFECT_TYPE
create_virtual_hsb	CREATE_VIRTUAL_HSB
cue	CUE
cue_beam_time	SETUP_CUE_BEAM_TIME
cue_color_time	SETUP_CUE_COLOR_TIME

/eos/key/	Internal Eos Command
cue_down_time	SETUP_CUE_DOWN_TIME
cue_focus_time	SETUP_CUE_FOCUS_TIME
cue_list	SFF_CUELIST
cue_sheet	CUE_SHEET
cue_up_time	SETUP_CUE_UP_TIME
cueonly	Q_ONLY
cueonlytrack	CUE_ONLY_TRACK
cues	SFF_CUES
curve	CURVE
curve_edit	EDIT_CONTROL
curves	SFF_CURVES
cycles	NUM_CYCLES
cycletime	CYCLE_TIME
data	DATA
data_mode_latch	DATA_MODE_LATCH
database_mode	CIAPATCH_DB_MODE
date	RTC_DATE
days	RTC_DAYS
decaytime	EFFECT_STEP_OUT_TIME
default	DEFAULT_INTERFACE
default_mode	MACRO_DEFAULT_MODE
degrees_per_rev	ENCODER_DEGREES_PER_REVOLUTION
delay	DELAY
delete	DELETE
delete_device	DELETE_DEVICE
delete_effect	DELETE_EFFECT
deleteconfirm	DELETE_CONFIRM
desk_settings	DESK_SETTINGS
detach	DETACH_DEVICE
device_clear_errors	DEVICE_CLEAR_ERRORS
device_dimmers	CIAPATCH_DEVICE_DIMMERS
device_disconnected	DEV_DISCONNECT
device_discovered	DEV_DISCOVERED
device_discovery	RDM_DISCOVERY_ENABLED
device_errors	DEVICE_ERRORS
device_ignore_errors	DEVICE_IGNORE_ERRORS
device_lamp_controls	DEVICE_LAMP_CONTROLS
device_mode	CIAPATCH_DEVICE_MODE
device_properties	DEVICE_PROPERTIES
device_rdm	CIAPATCH_DEVICE_RDM
device_sensors	DEVICE_SENSORS
device_system	CIAPATCH_DEVICE_SYSTEM
dimmer_double_offset	DIM_DOUBLE_OFFSET
direct_selectdc_recall_from	DIRECTSELECTDCRECALLFROM
direct_selects	SNAPSHOT_DIRECT_SELECTS

/eos/key/	Internal Eos Command
disable	DISABLE
disconnect_macro	DISCONNECT_MACRO
discrete	DISCRETE_PALETTE
display_beam_palettes	SS_DISPLAY_GX_PALETTES
display_channels	SS_DISPLAY_CHANNELS
display_color_palettes	SS_DISPLAY_COL_PALETTES
display_color_path	DISPLAY_COLOR_PATH_MODE
display_color_path_mode_latch	DISPLAY_COLOR_PATH_MODE_LATCH
display_effects	SS_DISPLAY_RCES
display_focus_palettes	SS_DISPLAY_POS_PALETTES
display_groups	SS_DISPLAY_GROUPS
display_intensity_palettes	SS_DISPLAY_INT_PALETTES
display_macros	SS_DISPLAY_MACROS
display_magic_sheets	SS_DISPLAY_MAGIC_SHEETS
display_palettes	SS_DISPLAY_PALETTES
display_presets	SS_DISPLAY_PRESETS
display_snapshots	SS_DISPLAY_SNAPSHOTS
display_time_mode_latch	DISPLAY_TIME_MODE_LATCH
display_timing	DISPLAY_TIME_MODE
displays	DISPLAYS
dmx	DMX_LEVEL
dmx_	DMX_INTERFACE
dmx_patch	SFF_DMXPATCH
done	DONE
douse	DOUSE
down	DOWN
duration	EFFECT_DURATION
duration	DURATION_NUM_CYCLES
dwel	DWELL
earliest	EARLIEST
earliest_m	EARLIEST_MARK_CUE
edit	EDIT
edit_frame	EDIT_FRAME
edit_mode	EDIT_MODE
edit_target	TARGET_EDIT_EVENT
edmx	EDMX
effect	EFFECT
effect_axis_wheel	EFFECT_AXIS_WHEEL
effect_edit	EFFECT_PATTERN_EDIT
effect_form_horizontal_wheel	EFFECT_FORM_HORIZONTAL_WHEEL
effect_form_vertical_wheel	EFFECT_FORM_VERTICAL_WHEEL
effect_rate_wheel	EFFECT_RATE_WHEEL
effect_rotate_wheel	EFFECT_ROTATE_WHEEL
effect_scale_wheel	EFFECT_SCALE_WHEEL
effect_shape_horizontal_wheel	EFFECT_SHAPE_HORIZONTAL_WHEEL



/eos/key/	Internal Eos Command
effect_shape_vertical_wheel	EFFECT_SHAPE_VERTICAL_WHEEL
effect_size_wheel	EFFECT_SIZE_WHEEL
effect_time_wheel	EFFECT_TIME_WHEEL
effects	SFF_EFFECTS
effectsub	EFFECT_SUB
element_bump_1	ELEMENT_BUMP_1
element_bump_10	ELEMENT_BUMP_10
element_bump_11	ELEMENT_BUMP_11
element_bump_12	ELEMENT_BUMP_12
element_bump_13	ELEMENT_BUMP_13
element_bump_14	ELEMENT_BUMP_14
element_bump_15	ELEMENT_BUMP_15
element_bump_16	ELEMENT_BUMP_16
element_bump_17	ELEMENT_BUMP_17
element_bump_18	ELEMENT_BUMP_18
element_bump_19	ELEMENT_BUMP_19
element_bump_2	ELEMENT_BUMP_2
element_bump_20	ELEMENT_BUMP_20
element_bump_21	ELEMENT_BUMP_21
element_bump_22	ELEMENT_BUMP_22
element_bump_23	ELEMENT_BUMP_23
element_bump_24	ELEMENT_BUMP_24
element_bump_25	ELEMENT_BUMP_25
element_bump_26	ELEMENT_BUMP_26
element_bump_27	ELEMENT_BUMP_27
element_bump_28	ELEMENT_BUMP_28
element_bump_29	ELEMENT_BUMP_29
element_bump_3	ELEMENT_BUMP_3
element_bump_30	ELEMENT_BUMP_30
element_bump_31	ELEMENT_BUMP_31
element_bump_32	ELEMENT_BUMP_32
element_bump_33	ELEMENT_BUMP_33
element_bump_34	ELEMENT_BUMP_34
element_bump_35	ELEMENT_BUMP_35
element_bump_36	ELEMENT_BUMP_36
element_bump_37	ELEMENT_BUMP_37
element_bump_38	ELEMENT_BUMP_38
element_bump_39	ELEMENT_BUMP_39
element_bump_4	ELEMENT_BUMP_4
element_bump_40	ELEMENT_BUMP_40
element_bump_41	ELEMENT_BUMP_41
element_bump_42	ELEMENT_BUMP_42
element_bump_43	ELEMENT_BUMP_43
element_bump_44	ELEMENT_BUMP_44
element_bump_45	ELEMENT_BUMP_45

/eos/key/	Internal Eos Command
element_bump_46	ELEMENT_BUMP_46
element_bump_47	ELEMENT_BUMP_47
element_bump_48	ELEMENT_BUMP_48
element_bump_49	ELEMENT_BUMP_49
element_bump_5	ELEMENT_BUMP_5
element_bump_50	ELEMENT_BUMP_50
element_bump_51	ELEMENT_BUMP_51
element_bump_52	ELEMENT_BUMP_52
element_bump_53	ELEMENT_BUMP_53
element_bump_54	ELEMENT_BUMP_54
element_bump_55	ELEMENT_BUMP_55
element_bump_56	ELEMENT_BUMP_56
element_bump_57	ELEMENT_BUMP_57
element_bump_58	ELEMENT_BUMP_58
element_bump_59	ELEMENT_BUMP_59
element_bump_6	ELEMENT_BUMP_6
element_bump_60	ELEMENT_BUMP_60
element_bump_7	ELEMENT_BUMP_7
element_bump_8	ELEMENT_BUMP_8
element_bump_9	ELEMENT_BUMP_9
element_pos_1	ELEMENT_POS_1
element_pos_2	ELEMENT_POS_2
element_pos_3	ELEMENT_POS_3
element_pps_4	ELEMENT_POS_4
enable	ENABLE
encoder_1	ENCODER1
encoder_2	ENCODER2
encoder_3	ENCODER3
encoder_4	ENCODER4
encoder_5	ENCODER5
encoder_6	ENCODER6
encoder_category_color	ENCODER_CAT_COLOR
encoder_category_custom	ENCODER_CAT_CUSTOM
encoder_category_focus	ENCODER_CAT_SPARE
encoder_category_form	ENCODER_CAT_BEAM
encoder_category_image	ENCODER_CAT_GRAPHIC
encoder_category_intensity	ENCODER_CAT_OTHER
encoder_category_shutter	ENCODER_CAT_SHUTTER
encoder_ext_1	ENCODER_EXT_1
encoder_ext_2	ENCODER_EXT_2
encoder_ext_3	ENCODER_EXT_3
encoder_ext_4	ENCODER_EXT_4
encoder_ext_5	ENCODER_EXT_5
encoder_ext_6	ENCODER_EXT_6
encoder_flexi	ENCODER_FLEXI

/eos/key/	Internal Eos Command
encoder_lockout	ENCODER_LOCKOUT
encoder_mode_1	ENCODER_MODE_1
encoder_mode_2	ENCODER_MODE_2
encoder_mode_3	ENCODER_MODE_3
encoder_mode_4	ENCODER_MODE_4
encoder_mode_5	ENCODER_MODE_5
encoder_wheel_move	ENCODER_WHEEL_MOVE
encoders	SNAPSHOT_ENCODERS
end_query	QUERY_COMPLETE
enter	ENTER
entry	ENTRY_MODE
entrytime	ENTRY_TIME
escape	ESCAPE
even	EVEN
even_effect	EFFECT_EVEN
event	SC_EVENT
eventlist	SC_EVENT_LIST
exclusive	EXCLUSIVE
execute	EXECUTE
exit	EXIT_MODE
exittime	EXIT_TIME
expand	EXPAND
expand_collapse_left	EXPAND_COLLAPSE_LEFT
expand_collapse_up	EXPAND_COLLAPSE_UP
expand_down	EXPAND_DOWN
expand_right	EXPAND_RIGHT
export_file	EXPORTFILE
export_folder	EXPORTFOLDER
export_media	EXPORTMEDIA
external	EXTERNAL
external_relationship	EXTERNAL_RELATIONSHIP
fade_by_rate	FADE_BY_RATE
fade_by_size	FADE_BY_SIZE
fade_by_size_and_rate	FADE_BY_SIZE_AND_RATE
fader	SC_SUB_FADER
fader_1	FADER01
fader_10	FADER10
fader_2	FADER02
fader_3	FADER03
fader_4	FADER04
fader_5	FADER05
fader_6	FADER06
fader_7	FADER07
fader_8	FADER08
fader_9	FADER09

/eos/key/	Internal Eos Command
fader_ab	FADER_AB
fader_assert	SLIDER_ASSERT
fader_control	FADER_CONTROLS
fader_display	FADER_DISPLAY
fader_mode	FADER_MODE
fader_off	FADER_OFF
fader_page_back	FADER_PAGE_BACK
fader_pages	FADER_PAGES
fader_rate	FADER_RATE
fadermodule_1_connected	SLIDER_MODULE1_CONNECTED
fadermodule_2_connected	SLIDER_MODULE2_CONNECTED
fadermodule_3_connected	SLIDER_MODULE3_CONNECTED
faderpagepress	FADER_PAGE_DOWN
faderpagerelease	FADER_PAGE_UP
faders	SNAPSHOT_SLIDERS
faderwing_page	FADER_PAGE_WING
fan_	FAN
fan_curve	FAN_CURVE
feedback_errors	SFF_ERRORS
filter	FILTER
filter_mode	FILTER_MODE
filters	SNAPSHOT_FILTERS
fine	FINE
finewheel	FINE_WHEEL
finewheelandencoderbutton	FINE_WHEEL_AND_ENCODER_BUTTON
first_time	START_TIME
fixtures	SFF_FIXTURELIST
flash	DIMMER_FLASH
flash_off	FLASH_OFF
flash_on	FLASH_ON
flexi_all	FLEXI_ALL
flexi_channel_partition_toggle	FLEXI_PARTITION_TOGGLE
flexi_in_use	FLEXI_ACTIVE
flexi_manual	FLEXI_MANUAL
flexi_moved	FLEXI_MOVED
flexi_patch	FLEXI_PATCH
flexi_selected	FLEXI_SEL
flexi_show	FLEXI_SHOW
flexi_time	FLEXI_TIME
flexichannel_mode	FLEXI_MODE
flip	FLIP
flip_h	PIXELMAP_FLIP_HORIZONTAL
flip_v	PIXELMAP_FLIP_VERTICAL
focus	FOCUS_CAT
focus_effect	FOCUS_EFFECT

/eos/key/	Internal Eos Command
focus_palette	FOCUS_PALETTE
follow	FOLLOW
force_grandmaster_move	FORCE_GRANDMASTER_MOVE
foreground_mode	MACRO_USER
form	FORM_CAT
format	FORMAT
forward	FORWARD
frame_rate	FRAME_RATE
freeze	PLAYBACK_FREEZE
friday	RTC_FRIDAY
full	FULL
gel	DB_GEL
gel_	COLOR_FADE_GEL_SIM
gel_match_setting_brightest	GEL_MATCH_BRIGHTEST_SETTING
gel_match_setting_hybrid	GEL_MATCH_HYBRID_SETTING
gel_match_setting_spectrum	GEL_MATCH_SPECTRUM_SETTING
gio_encoder_display	GIO_ENCODER_DISPLAY
global	GLOBAL_PALETTE
gm_exempt	GM_EXEMPT
go	PLAYBACK_GO (Master Fader)
go_0	GO (Master Fader)
go_to_cue	GO_TO_CUE
go_to_cue_0	FADER_GO_TO_CUE_0
gocue0	PLAYBACK_CUE_ZERO
gotocue	PLAYBACK_GOTOCUE
gotocuetime	GOTO_CUE_TIME
grandmaster	GRANDMASTER_MOVE
greater_than	GREATER_THAN
group	GROUP
group_channels_by_5	GROUP_CHANNELS_BY_5
grouping	GROUPING
groups	SFF_GROUPS
hang	HANG
haptic_encoder_wheel_move	HAPTIC_ENCODER_WHEEL_MOVE
haptic_level_wheel_move	HAPTIC_LEVEL_WHEEL_MOVE
haptic_rate_wheel_move	HAPTIC_RATE_WHEEL_MOVE
hard_poweroff	HARD_POWEROFF
height	PIXEL_HEIGHT
help	HELP
hform	HORIZ_FORM
hide_cia	CIA_HIDE
hide_mouse	HIDE_MOUSE
high_contrast_displays	HIGH_CONTRAST_DISPLAYS
highlight	HIGHLIGHT
highlight_append	HIGHLIGHT_APPEND

/eos/key/	Internal Eos Command
highlight_preset	HIGHLIGHT_PRESET
highlight_remdim	HIGHLIGHT_REM_DIM
hold	HOLD
home	HOME
home_preset	HOME_PRESET
hs	COLOR_FADE_HS
htp	HTP
htp_	ONLY_HTP
image	IMAGE_CAT
import_all_media	IMPORTALLMEDIA
import_ascii_file	IMPORTASCIIFILE
import_asciifile_custom	IMPORTASCIIFILE_CUSTOM
import_file	IMPORTFILE
import_gobo	IMPORTGOBO
import_path	IMPORT_PATH
import_show_media	IMPORTSHOWMEDIA
in_time	TIME_EFFECT
include_color_fade	INCLUDE_COLOR_FADE
independent	INDEPENDENT
infinite	EFFECT_INFINITE
inhibitive	INHIBITIVE
input_string	SC_INPUT_STRING
insert	INSERT
insert_after	INSERT_AFTER
insert_before	INSERT_BEFORE
insert_channel	INSERT_CHANNEL
int	INT
intensity	INTENSITY_CAT
intensity_block	INTENSITY_BLOCK
intensity_master	INTENSITY_MASTER
intensity_palette	INTENSITY_PALETTE
intensitydown	INTENSITY_DOWN
intensityup	INTENSITY_UP
interface	INTERFACE
interleave	FAN_INTERLEAVE
internal	INTERNAL
interpolate	INTERPOLATE
intime	EFFECT_STEP_IN_TIME
intime_effect	INTIME_EFFECT
invert	PIXELMAP_SELECT_INVERT
invert_pan	INVERT_PAN
invert_tilt	INVERT_TILT
ion_encoder_1	ION_ENCODER_1
ion_encoder_2	ION_ENCODER_2
ion_encoder_3	ION_ENCODER_3

/eos/key/	Internal Eos Command
ion_encoder_4	ION_ENCODER_4
is_in	IS_IN
isn't_in	ISNT_IN
jump	FAN_JUMP
keyboard_shortcuts	KEYBOARD_SHORTCUTS
keywords	KEYWORDS
label	LABEL
lamp_control	LAMP_CONTROLS
lamp_controls_edit	CIAPATCH_LAMPCMDS
lamp_ctrls	LAMP_CONTROL_KEYS
lamp_on	LAMP_ON
landscape	LANDSCAPE
last	LAST
last_ref	LAST_REF
last_ref_off	LAST_REF_OFF
last_time	END_TIME
layer_chan	LAYER_CHAN
ld_flags	PATCH_LD_FLAGS
learn	LEARN
learn_time_discrete_steps	LEARN_DISCRETE_TIME
learn_time_sample_bpm	LEARN_TIME
left_side_sk_1	LEFT_SIDE_SK_1
left_side_sk_2	LEFT_SIDE_SK_2
left_side_sk_3	LEFT_SIDE_SK_3
left_side_sk_4	LEFT_SIDE_SK_4
left_side_sk_5	LEFT_SIDE_SK_5
left_side_sk_6	LEFT_SIDE_SK_6
left_side_sk_7	LEFT_SIDE_SK_7
less_than	LESS_THAN
level	LEVEL
level_	VALUE
level_wheel_move	LEVEL_WHEEL_MOVE
lightwright	LW_FIELDS
linear	LINEAR_EFFECT
link	LINK
list_partition	CUE_PARTITION
listview	LIST_VIEW
live	LIVE
live_	FROM_LIVE
live_remdim_level	REM_DIM_LEVEL
load	LOAD_PLAYBACK
loadcue	LOAD
loadforgo	LOAD_AS_ENTER
lock	LOCKED_PALETTE
loop	LOOP

/eos/key/	Internal Eos Command
lowlight_preset	LOWLIGHT_PRESET
ltp	LTP
luminaire	LUMINAIRE
macro	MACRO
macro_1	MACRO1
macro_2	MACRO2
macro_3	MACRO3
macro_4	MACRO4
macro_5	MACRO5
macro_6	MACRO6
macro_7	MACRO7
macro_8	MACRO8
macro_801	MACRO_801
macro_802	MACRO_802
macro_803	MACRO_803
macro_804	MACRO_804
macro_805	MACRO_805
macro_806	MACRO_806
macro_807	MACRO_807
macro_808	MACRO_808
macro_809	MACRO_809
macro_810	MACRO_810
macro_811	MACRO_811
macro_812	MACRO_812
macro_813	MACRO_813
macro_814	MACRO_814
macro_815	MACRO_815
macro_816	MACRO_816
macro_817	MACRO_817
macro_818	MACRO_818
macro_819	MACRO_819
macro_820	MACRO_820
macro_button	MACRO_STAR
macro_entry_delete	MACRO_ENTRY_DELETE
macro_loop_begin	MACRO_LOOP_BEGIN
macro_loop_end	MACRO_LOOP_END
macro_loop_num	MACRO_LOOP_NUM_BEGIN
macro_mode	MACRO_MODE
macro_wait	MACRO_WAIT
macros	SFF_MACROS
magic_sheet	MAGIC_SHEET
magic_sheet_apply	MAGICSHHEET_APPLY
magic_sheet_edit	MAGICSHHEET_EDIT
magic_sheet_recall	MAGICSHHEET_RECALL
magic_sheets	SFF_MAGICSHETS



/eos/key/	Internal Eos Command
make_absolute	MAKE_ABSOLUTE
make_manual	MAKE_MANUAL
make_null	MAKE_NULL
manual	MANUAL
manual_master	MANUAL_MASTER
manual_override	MANUAL_OVERRIDE
mark	MARK
mark_cue_designation	MARK_CUE_DESIGNATION
mark_time	MARK_TIME
marks	DELAY_MARKS
media	SFF_RESOURCELIST
midi	MIDI
midi_cue_list	MIDI_CUELIST
midi_raw	MIDI_STRING
miditimecode	MIDI_TC
min	MIN
minimum	RESTORE_MINIMUM
minus_links	MINUS_LINKS
mirror_in	FAN_MIRROR_IN
mirror_mode	MIRROR
mirror_out	FAN_MIRROR_OUT
module_1_connected	MODULE1_CONNECTED
module_1_disconnected	MODULE1_DISCONNECTED
module_2_connected	MODULE2_CONNECTED
module_2_disconnected	MODULE2_DISCONNECTED
module_3_connected	MODULE3_CONNECTED
module_3_disconnected	MODULE3_DISCONNECTED
monday	RTC_MONDAY
month	RTC_MONTH
more_softkeys	MORE_SOFTKEYS
move_to	MOVE_TO
movefade	MOVEFADE
moves_only	MOVES_ONLY
msc_acn_rx_ids	MSC_ACN_RECEIVE
msc_acn_tx_id	MSC_ACN_TRANSMIT
msc_receive	MSC_RECEIVE
msc_transmit	MSC_TRANSMIT
multi_param	MULTI_PARAM
multiconsole_power_off	MULTICONSOLE_POWEROFF
multiconsole_power_on	MULTICONSOLE_POWERON
native	COLOR_FADE_NATIVE
negative	NEGATIVE
new_keyword	NEW_KEYWORD
new_show	NEW_SHOW
next	NEXT

/eos/key/	Internal Eos Command
next_blind_display	NEXT_BLIND_DISPLAY
next_live_display	NEXT_LIVE_DISPLAY
no_priority	NO_PRIORITY
notes	NOTES
num_groups	FAN_NUM_GROUPS
numofchannels	NUM_OF_CHANS
odd	ODD
off	BUMP_OFF
offline	OFFLINE
offset	OFFSET
offstate	OFF_STATE
on	BUMP_ON
only_active	ONLY_ACTIVE
only_labels	ONLY_LABELS
only_levels	ONLY_LEVELS
only_show	ONLY_SHOWDATA
only_text	ONLY_TEXT
onstate	ON_STATE
oos_sync	OOS_SYNC
open_bp_blind	OPEN_BEAM_PALETTE_PREVIEW
open_browser	OPENBROWSER
open_chan_effect_display	OPEN_CHAN_EFFECT_DISPLAY
open_color_path_blind	OPEN_COLOR_PATH_PREVIEW
open_color_picker	OPENCOLORPICKER
open_cp_blind	OPEN_COLOR_PALETTE_PREVIEW
open_cue_blind	OPEN_CUE_LIST_INDEX
open_curve_preview	OPEN_CURVE_PREVIEW
open_dmx_patch	OPEN_DMX_PATCH
open_effect_blind	OPEN_EFFECT_PREVIEW
open_effect_status	OPENEFFECTSTATUS
open_fader_config	OPENSLIDERCONFIGURATION
open_file	OPENFILE
open_fp_blind	OPEN_FOCUS_PALETTE_PREVIEW
open_group_blind	OPEN_GROUP_PREVIEW
open_ip_blind	OPEN_INTENSITY_PALETTE_PREVIEW
open_macro_preview	OPEN_MACRO_PREVIEW
open_magic_sheet_blind	OPEN_MAGIC_SHEET_PREVIEW
open_mirror_dialog	OPEN_MIRROR_DIALOG
open_ml_controls	OPEN_ML_CONTROLS
open_park_blind	OPEN_PARK_PREVIEW
open_partition_preview	OPEN_PARTITION_PREVIEW
open_pattern_effects	OPEN_PATTERN_EFFECTS
open_preset_blind	OPEN_PRESET_PREVIEW
open_setup	OPEN_SETUP
open_sub_blind	OPEN_SUBMASTER_PREVIEW

/eos/key/	Internal Eos Command
or	OR
ordered_view	ORDERED_VIEW
osc	OSC_ENABLED
osc_rx_port_number	OSC_RX_PORT_NUMBER
osc_tx_ip_address	OSC_TX_IP_ADDRESS
osc_tx_port_number	OSC_TX_PORT_NUMBER
out	OUT
page_column_1	PAGE_COLUMN_1
page_column_2	PAGE_COLUMN_2
page_column_3	PAGE_COLUMN_3
page_column_4	PAGE_COLUMN_4
page_column_5	PAGE_COLUMN_5
page_column_6	PAGE_COLUMN_6
page_column_7	PAGE_COLUMN_7
page_down	PAGE_DOWN
page_encoders_down	PAGE_ENCODERS_DOWN
page_encoders_up	PAGE_ENCODERS_UP
page_mode	SCROLL_MODE
page_up	PAGE_UP
palettes	SFF_PALETTES
paper_size_a2	PAPER_SIZE_A2
paper_size_a3	PAPER_SIZE_A3
paper_size_a4	PAPER_SIZE_A4
paper_size_legal	PAPER_SIZE_LEGAL
paper_size_letter	PAPER_SIZE_LETTER
paramcategory	PARAM_CAT_PRE_v1_9_8
parameter_view	PARAM_VIEW
parameters	PARAMETERS
park	PARK
part	PART
partition	PARTITION
partitionedcontrol	PARTITIONED_CONTROL
patch	PATCH
patch_1_to_1	RESET_PATCH
patch_done	CIAPATCH_DONE
patch_manu_tab	PATCH_MANU_TAB
patch_mode	CIAPATCH_PATCH_MODE
patch_show_tab	PATCH_SHOW_TAB
patch_user_tab	PATCH_USER_TAB
path	COLOR_PATH
pattern	PATTERN
pdv_point	PDV_POINT
pdv_time	PDV_TIME
percent_per_rev	ENCODER_PERCENT_PER_REVOLUTION
pixel_map_apply_check	PIXELMAP_APPLY_CHECK

/eos/key/	Internal Eos Command
pixel_map_column_guides	PIXELMAP_COLUMN_GUIDES
pixel_map_delete	PIXELMAP_DELETE
pixel_map_direction	PIXELMAP_DIRECTION
pixel_map_done	PIXELMAP_APPLY
pixel_map_edit	PIXELMAP_EDIT
pixel_map_file	PIXELMAP_FILE
pixel_map_flash	PIXELMAP_FLASH
pixel_map_horizontal_order	PIXELMAP_HORIZONTAL_ORDER
pixel_map_last	PIXELMAP_LAST
pixel_map_library	PIXELMAP_LIBRARY
pixel_map_mask	PIXELMAP_MASK
pixel_map_next	PIXELMAP_NEXT
pixel_map_overlay	PIXELMAP_OVERLAY
pixel_map_overwrite	PIXELMAP_OVERWRITE
pixel_map_reorder_files	PIXELMAP_REORDER_FILES
pixel_map_reorder_libraries	PIXELMAP_REORDER_LIBRARIES
pixel_map_row_guides	PIXELMAP_ROW_GUIDES
pixel_map_snapshot	PIXELMAP_SNAPSHOT
pixel_map_start_address	PIXELMAP_START_ADDRESS
pixel_map_vertical_order	PIXELMAP_VERTICAL_ORDER
pixel_maps	SFF_PIXELMAPS
pixelmap	PIXELMAP
playback_clear_cues	PLAYBACK_CLEAR_CUES
playbackassert	PLAYBACK_ASSERT
playbackmanual	PLAYBACK_MANUAL_OVERRIDE
playbackmove	PLAYBACK_MOVE
playbackoff	PLAYBACK_OFF
playbackrate	PLAYBACK_RATE
playbackrelease	PLAYBACK_RELEASE
plus_patch	PLUS_PATCH
plus_show	ENTIRE_SHOW
popup_virtual_keyboard	POPUV_VIRTUAL_KEYBOARD
port_offset	PORT_OFFSET
portrait	PORTRAIT
positive	POSITIVE
post_select_softkeys	POST_SELECT_SOFTKEYS
power_off	POWEROFF
preheat	PREHEAT
preheat_off	PREHEAT_OFF
preheat_time	PREHEAT_TIME
preserve_blind_cue	PRESERVE_BLIND_CUE
preserve_native_on_patch_change	PRESERVE_NATIVE_ON_PATCH_CHANGE
preset	PRESET
presets	SFF_PRESETS
prev_channels	RESTORE_CHANNEL_LIST

/eos/key/	Internal Eos Command
previous	RESTORE_PREVIOUS
print_color_printout	PRINT_COLOR_PRINTOUT
print_feedback_errors	PRINT_FEEDBACK_ERRORS
print_file	PRINTFILE
print_folder	PRINTFOLDER
print_summary_view	PRINT_SUMMARY_VIEW
print_tracked_levels	PRINT_TRACKED_LEVELS
priority	SOURCE_PRIORITY
properties	PROPERTIES
proportion	PROPORTION
proportional_master	PROPORTIONAL_MASTER
psd_time_countdown	DISPLAY_FADING_CUE_TIME
query	QUERY
quit	QUIT
random	RANDOM
random_groups	RANDOM_GROUPS
random_rate	RANDOM_RATE
rate	RATE
rate_wheel_move	RATE_WHEEL_MOVE
ratewheel	RATE_WHEEL
rce_channels	EFFECT_CHANNELS
rce_insert	EFFECT_INSERT
rce_on_off	EFFECT_ON_OFF
recall_from	RECALL_FROM
receivechan	MSC_RECEIVE_CHAN
record	RECORD
record_only	RECORD_ONLY
record_rig_check	DIMRACK_REC_RIG_CHK
recordconfirm	RECORD_CONFIRM
redo	REDO
ref_only	REFERENCES_ONLY
relay	RELAY
relay_output	RELAY_OUTPUT
release	RELEASE_FADER
rem_dim	REM_DIM
remfiltercat	REM_FILTER_CAT
remfilterparam	REM_FILTER_PARAM
remove_favorite	PATCH_REMOVE_FAVORITE
reorder	REORDER
repeat	FAN_REPEAT
repeat_last_command	REPEAT_LAST_COMMAND
repeat_on_go	EFFECT_REPEAT
replace	REPLACE_ADDRESS
replace_with	REPLACE_WITH
request_file	REQUESTFILE

/eos/key/	Internal Eos Command
reset_all_tabs	RESET_ALL_TABS
reset_columns	RESET_COLUMNS
reset_desk_settings	RESET_DESK_SETTINGS
reset_show_settings	RESET_SHOW_SETTINGS
reset_system	RESET_SYSTEM
reset_update	UPDATE_CLEAR
restart_effect	REFIRE_EFFECT
restore	RESTORE_MODE
resume	RESUME
resyncframes	RESYNC_FRAMES
reverse	REVERSE
reverse_steps	REVERSE_STEPS
rfr	RFR_ENABLE
rgb	COLOR_FADE_RGB
rotate_90	PIXELMAP_ROTATE_90
rpu_1	RPU_1
rpu_10	RPU_10
rpu_11	RPU_11
rpu_12	RPU_12
rpu_13	RPU_13
rpu_14	RPU_14
rpu_15	RPU_15
rpu_16	RPU_16
rpu_17	RPU_17
rpu_18	RPU_18
rpu_19	RPU_19
rpu_2	RPU_2
rpu_20	RPU_20
rpu_21	RPU_21
rpu_3	RPU_3
rpu_4	RPU_4
rpu_5	RPU_5
rpu_6	RPU_6
rpu_7	RPU_7
rpu_8	RPU_8
rpu_9	RPU_9
rtc	RTC
rtc_time	RTC_TIME
run_cue	RUN_CUE
run_rig_check	DIMRACK_RUN_RIG_CHK
rvi_settings	RVI_SETTINGS
sacn	ACN
sat_adjust	COLOR_FADE_SAT
saturday	RTC_SATURDAY
save	SAVE

/eos/key/	Internal Eos Command
save_file	SAVEFILE
save_folder	SAVEFOLDER
save_show	SAVE_SHOW
scale	SCALE
scroller_frame	SCROLLER_FRAME
second_action	SECOND_ACTION
security_settings	SECURITY_SETTINGS
select	SELECT
select_active	SELECT_ACTIVE
select_all	SELECT_ALL
select_last	SELECT_LAST
select_last_params	SELECT_LAST_PARAMS
select_live_cue_blind	SELECT_LIVE_CUE_BLIND
select_live_cue_live	SELECT_LIVE_CUE_LIVE
select_manual	SELECT_MANUAL
select_nonsub_active	SELECT_NONSUB_ACTIVE
send_midi_raw	SEND_MIDI_STRING
send_string	SEND_SERIAL_STRING
server_chan	MAIN_LAYER_CHAN
set_chan_level	SET_CHAN_LEVEL
setup	SETUP
shield	SHIELDED_SUB
shift	SHIFT
show_channels	SFF_SHOWCHANNELS
show_control	SFF_SHOWCONTROL
show_control_action	SC_ACTION
show_park_buffer	SHOW_PARK_BUFFER
show_ref_labels	SHOW_REF_LABELS
show_reference_labels	SHOW_REFERENCE_LABELS
show_settings	SHOW_SETTINGS
show_source_data	SHOW_SOURCE_DATA
show_stored_data	SHOW_STORED_DATA
shutdown_fixture	SHUTDOWN_LAMP
shutdown_macro	SHUTDOWN_MACRO
shutter	SHUTTER_CAT
single_param	SINGLE_PARAM
size	SIZE
slider_move	SLIDER_MOVE
smpte	SMPTE
smptetimecode	SMPTE_TC
snap	CIAPATCH_SNAP
snapshot	SNAPSHOT
snapshot_recall	SNAPSHOTRECALL
snapshots	SFF_SNAPSHOTS
sneak	SNEAK

/eos/key/	Internal Eos Command
softkey_1	SOFTKEY1
softkey_2	SOFTKEY2
softkey_3	SOFTKEY3
softkey_4	SOFTKEY4
softkey_5	SOFTKEY5
softkey_6	SOFTKEY6
softkey_7	SOFTKEY7
softkey_8	SOFTKEY8
solo	EFFECT_SOLO
solo_mode	SOLO_MODE
solo_status	SOLO_STATUS
source	SOURCE
spacebar_go	SPACEBAR_DISABLE
split_cue_time	SPLIT_CUE_TIME
spread	EFFECT_SPREAD
spreadsheet	SPREADSHEET
startup_macro	STARTUP_MACRO
status	EFFECT_STATUS
step	STEP
stepbased	STEPBASED_EFFECT
steptime	STEP_TIME
stop	STOP
stop_1	STOP01
stop_10	STOP10
stop_2	STOP02
stop_3	STOP03
stop_4	STOP04
stop_5	STOP05
stop_6	STOP06
stop_7	STOP07
stop_8	STOP08
stop_9	STOP09
stop_all	STOP_ALL_EFFECT
stop_and_fade	STOP_AND_FADE
stop_and_hold	STOP_AND_HOLD
stop_effect	STOP_EFFECT
stop_effect_button	STOP_EFFECT_BUTTON
stopback	PLAYBACK_STOP_BACK
stopeffect	STOP_EFFECT
string	SERIAL_STRING
string_and_osc_rx	SERIAL_RX_ENABLE
string_and_osc_tx	SERIAL_TX_ENABLE
string_midi_tx	SERIAL_MIDI_TX
string_rx_group_ids	SERIAL_RX_GROUP_IDS
string_rx_port	SERIAL_RX_PORT_NUMBER



/eos/key/	Internal Eos Command
string_tx_group_ids	SERIAL_TX_GROUP_IDS
string_tx_ip_address	SERIAL_TX_IP_ADDRESS
string_tx_port	SERIAL_TX_PORT_NUMBER
sub	SUBMASTER
subassert	SUB_ASSERT
subdown	SUB_BUMP_DOWN
subfreeze	SUB_FREEZE
submasters	SFF_SUBMASTERS
submove	SUB_MOVE
suboff	SUB_OFF
subrelease	SUB_RELEASE
subtype	SUB_TYPE
subup	SUB_BUMP_UP
sunday	RTC_SUNDAY
sw_go_1	SW_GO_1
sw_go_10	SW_GO_10
sw_go_11	SW_GO_11
sw_go_12	SW_GO_12
sw_go_13	SW_GO_13
sw_go_14	SW_GO_14
sw_go_15	SW_GO_15
sw_go_16	SW_GO_16
sw_go_17	SW_GO_17
sw_go_18	SW_GO_18
sw_go_19	SW_GO_19
sw_go_2	SW_GO_2
sw_go_20	SW_GO_20
sw_go_21	SW_GO_21
sw_go_22	SW_GO_22
sw_go_23	SW_GO_23
sw_go_24	SW_GO_24
sw_go_25	SW_GO_25
sw_go_26	SW_GO_26
sw_go_27	SW_GO_27
sw_go_28	SW_GO_28
sw_go_29	SW_GO_29
sw_go_3	SW_GO_3
sw_go_30	SW_GO_30
sw_go_31	SW_GO_31
sw_go_32	SW_GO_32
sw_go_33	SW_GO_33
sw_go_34	SW_GO_34
sw_go_35	SW_GO_35
sw_go_36	SW_GO_36
sw_go_37	SW_GO_37

/eos/key/	Internal Eos Command
sw_go_38	SW_GO_38
sw_go_39	SW_GO_39
sw_go_4	SW_GO_4
sw_go_40	SW_GO_40
sw_go_5	SW_GO_5
sw_go_6	SW_GO_6
sw_go_7	SW_GO_7
sw_go_8	SW_GO_8
sw_go_9	SW_GO_9
sw_stop_1	SW_STOP_1
sw_stop_10	SW_STOP_10
sw_stop_11	SW_STOP_11
sw_stop_12	SW_STOP_12
sw_stop_13	SW_STOP_13
sw_stop_14	SW_STOP_14
sw_stop_15	SW_STOP_15
sw_stop_16	SW_STOP_16
sw_stop_17	SW_STOP_17
sw_stop_18	SW_STOP_18
sw_stop_19	SW_STOP_19
sw_stop_2	SW_STOP_2
sw_stop_20	SW_STOP_20
sw_stop_21	SW_STOP_21
sw_stop_22	SW_STOP_22
sw_stop_23	SW_STOP_23
sw_stop_24	SW_STOP_24
sw_stop_25	SW_STOP_25
sw_stop_26	SW_STOP_26
sw_stop_27	SW_STOP_27
sw_stop_28	SW_STOP_28
sw_stop_29	SW_STOP_29
sw_stop_3	SW_STOP_3
sw_stop_30	SW_STOP_30
sw_stop_31	SW_STOP_31
sw_stop_32	SW_STOP_32
sw_stop_33	SW_STOP_33
sw_stop_34	SW_STOP_34
sw_stop_35	SW_STOP_35
sw_stop_36	SW_STOP_36
sw_stop_37	SW_STOP_37
sw_stop_38	SW_STOP_38
sw_stop_39	SW_STOP_39
sw_stop_4	SW_STOP_4
sw_stop_40	SW_STOP_40
sw_stop_5	SW_STOP_5

/eos/key/	Internal Eos Command
sw_stop_6	SW_STOP_6
sw_stop_7	SW_STOP_7
sw_stop_8	SW_STOP_8
sw_stop_9	SW_STOP_9
swap	SWAP
swap_address	SWAP_ADDRESS
swap_pan/tilt	SWAP_FIXTURE
system_settings	SFF_SYSTEMSETTINGS
tab	SHEET
tab_down	TAB_DOWN
tab_up	TAB_UP
tb_pan_swap	TB_PAN_SWAP
tb_tilt_swap	TB_TILT_SWAP
tb_xy_swap	TB_XY_SWAP
test_fixture	TEST_LAMP
text1	TEXT1
text10	TEXT10
text2	TEXT2
text3	TEXT3
text4	TEXT4
text5	TEXT5
text6	TEXT6
text7	TEXT7
text8	TEXT8
text9	TEXT9
thru	THRU
thursday	RTC_THURSDAY
time	TIME
time_code	CUE_TIME_CODE
time_template	TIME_TEMPLATE
timing_disable	TIMING_DISABLE
timing_disable_back	TIMING_DISABLE_BACK
timing_disable_go	TIMING_DISABLE_GO
timing_disable_time	TIMING_DISABLE_TIME
timingdisable	PLAYBACK_TIMING_DISABLE
toggle_accel	ENCODER_TOGGLE_ACCELERATION
toggle_effect_shape_mode_for_encoder	EFFECT_ENCODER_SHAPE_MODE_TOGGLE
toggle_effects	TOGGLE_EFFECTS
trace	TRACE
track	TRACK
tracking	TRACKING_MODE
trail	TRAIL
transmitchan	MSC_TRANSMIT_CHAN
trckbll_on/off	TRACKBALL_PAN_TILT_TOGGLE
tuesday	RTC_TUESDAY

/eos/key/	Internal Eos Command
type	TYPE
undo	UNDO
undouble	DIMMER_UNDOUBLE
unknown	UNOWN
unpatch	UNPATCH
unpatched	UNPATCHED_QUERY
up	UP_TIME
update	UPDATE
update_lin	UPDATE_LIB
update_mode	UPDATE_MODE
user_id	USER_ID
utilization_reports	SFF_UTILREPORTS
vform	VERT_FORM
view	MAGICSHEET_VIEW
view_channels	FLEXI_VIEW_CHANNELS
visible_workspaces	SNAPSHOT_MONITORS
vplaybackmove	VPLAYBACK_MOVE
vsubmove	VIRT_SUB_MOVE
wait_for_enter	MACRO_PAUSE_FOR_ENTER
wait_for_input	MACRO_PAUSE_FOR_INPUT
wednesday	RTC_WEDNESDAY
wheel	WHEEL
wheel0	WHEEL0
wheel1	WHEEL1
wheel2	WHEEL2
wheel3	WHEEL3
wheel4	WHEEL4
wheel5	WHEEL5
wheel6	WHEEL6
wheel7	WHEEL7
wheel8	WHEEL8
wheel9	WHEEL9
wheelencoderbutton	WHEEL_AND_ENCODER_BUTTON
white_point	PATCH_WHITE_POINT
white_point_xyz	PATCH_WHITE_POINT_XYZ
width	PIXEL_WIDTH
year	RTC_YEAR

# Facepanel Shortcuts

---

## Overview

The following is a list of button pushes: single, maintained, or combined. It is highly recommended that you read and familiarize yourself with this list.

For keyboard shortcuts, see [Eos Family Hotkeys](#).

## Displays

- **[Data]** (maintained press) - toggles the display to show data living under referenced data. Keep **[Data]** depressed to page. **[Data] & [Data]** locks this display.
- **[About] & [Data]** - locks the display to the absolute data display.
- **[Time]** (maintained press) - toggles the display to show discrete timing. Keep **[Time]** depressed to page.
- **[About] & [Time]** - locks the display to discrete time display.
- **[About] & [Time] [Time]** - latches the display to discrete timing.
- **[Data] & [Focus] / [Color] / [Beam]** - to expand/ suppress categories on displays. (Ion)
- **[Data] & {Parameter Tiles}** - to suppress/ display individual parameters from the display when not in summary view. (Ion)
- **[Params] & [Focus] / [Color] / [Beam]** - to expand/ suppress categories on displays. (Ti/ Eos/ Gio)
- **[Params] & {Parameter Tiles}** - to suppress/ display individual parameters from the display when not in summary view. (Ti/ Eos/ Gio)
- **[Displays] & [Level Wheel]** - dim the Littlelites or backlighting/ LCDs (as selected by the user).
- **[Displays] [Displays]** - resets the CIA to the browser.
- **[Shift] & [Left], [Shift] & [Right]** - move columns.
- **[Shift] & [Up], [Shift] & [Down], [Shift] & [Level Wheel]** - resize columns.
- **[About] & [Path]/[Color Path]** - toggles the display to show the color paths.
- **[Shift] & [Select]** - reset display columns.
- **[Shift] & [Tab]** - clear all tabs on the current monitor (but keep locked frames) (Does not clear tab 1 and 2).
- **[Shift] & [Tab] [Tab]** - clear all tabs on all monitors (but keep locked frames) (Does not clear tab 1 and 2).
- **[Shift] & [Tab] [Tab] [Tab]** - clear all tabs on all monitors (including locked frames) (does not clear tab 1 and 2).
- **[Shift] & [Label]** - opens the cue note for the selected cue. Adds a note to a currently selected cue if one doesn't already exist.
- **[About] & [Label] [About] & [Label]** - double press to lock reference labels on. Press **[About & [Label]** again to unlock.
- **[Shift] & [Live/ Blind]** - advances the displays to the next instance of Live or Blind.
- **[Live]** (when already in Live) - resyncs the selected cue to the most recently activated cue.
- **[Blind]** (when already in Blind) - resyncs the selected cue to the live selected cue (when blind cue has been changed or when preserve blind cue has been enabled).
- **[Flexi] & [Time]** - to invoke flexi time view on displays.
- **[Format] & [Level Wheel]** - zooms the display in focus.
- **Left Mouse Button & Scroll** - zooms the display in focus on a PC.
- **Scroll with two fingers** - zooms the display in focus on a Mac.
- **[Tab] & [Up/Down Arrow]** - cycle workspaces.

- **[Tab] & [Left/Right Arrow]** - move displays.
- **[Tab] & [number]** - open or focus specific displays.
- **[Flexi] & [.]** - turns on Flexi multicells off mode. Press again to turn off.
- **[About] & [Live]** - displays the DMX values.
- **[About] & [Mark]** - displays the mark cue used by the channels.
- **[About] & [Next]/[Last]** - displays the next cue that the channels move in or the last cue that the channels moved in.
- **[About] & [Park]** - displays the parked levels.
- **[About] & [Part]** - displays the cue part number for each parameter.

## Facepanel

- **[Shift] & [Escape]** - to lock and unlock face panel.
- **Encoder Paging Keys & [Number]** - pages to the desired encoder control page.
- **[Escape] & Encoder Paging Keys** - locks the encoders. Press any encoder page button to unlock.
- **[Flexi] & Encoder Paging Key** - to invoke flexi encoder states.
- **[Fader Controls] & [Bump Button]** - select a fader page on wings.
- **[Fader Page] & Rate Wheel** - rolls the selected fader page. (Ti/Eos/Gio)
- **[Fader Page] & [number]** - select a fader page on integral faders. (Ti/Eos/Gio)
- **[Fader Page]** - increments the fader page by 1.(Ti/Eos/Gio)
- **[Shift] & [Fader Page]** - decrements the fader page by 1. (Ti/Eos/Gio)
- **[Learn] & [Load]** - opens the selected fader's configuration tools.
- **[Off] & [Load]** - releases control of content, restoring to background and leave cue list with pending cue in tact.
- **[Release] & [Load]** - releases control of content, restoring to background, and resets cue list to top.
- **[Shift] & [Go] or [Shift] & [Back]** - cuts the pending cue or the previous cue.
- **[Shift] & [Load]** - to remove content from a fader.

## Operations

- **[At] [Enter]** - removes move information from selected channel/parameters.
- **[At] [At]** - set to Level (as defined in Setup).
- **[Color] (Encoder Paging Key) & Encoder Movement** - hold Color Point while adjusting parameters.
- **[Copy To] [Copy to]** - posts Move To on the command line.
- **[Full] [Full]** - sets selected channels intensity to "full" and self terminates.
- **[Label] [Label]** - appended to a record target command, clears the current label, this includes show file labels.
- **[Recall From] [Recall From]** - posts Recall From Cue to the command line.
- **[Record] [Record]** - posts Record Only to the command line.
- **[Select Active] [Select Active]** - Select Active minus submaster contributions.
- **[Shift] & [Select Active]** - posts Select Non-Sub Active.
- **[Select Last]** - repeats last command line, unterminated; does a loop of last five commands.
- **[Shift] & [At]** - recalls last channel(s) and parameters without terminating; does a loop of last five commands.
- **[Shift] & [Enter]** - reselects the last command and leaves it unterminated; does a loop of last five commands.
- **[Shift] & [Block]** - posts Intensity Block to the command line.
- **[Shift] & [Clear]** - clears the command line.
- **[Shift] & [Delay]** - posts follow.

- **[Shift] & Encoder Paging Key** - posts the category to the command line. For beam subcategories, press Image, Form or Shutter twice to post Beam. (Ion/Gio)
- **[Shift] & Encoder Movement** - accesses fine mode.
- **[Shift] & Encoder Push/ Toggle** - posts the parameter to the command line. (Ion)
- **[Shift] & Gel Tile** - cycles through three modes of Brightness.
- **[Shift] & [Full]** or **[Shift] & [Out]** - flash on or flash out.
- **[Shift] & [+]** or **[Shift] & [-]** - +% or -%.
- **[Shift] & [Highlight]** - appends highlight to the current channel selection.
- **[Shift] & [Parameter]** - from the encoder controls, posts the parameter to the command line.
- **[Shift] & [Select Last]** - posts additional channel selection options to the softkeys.
- **[Shift] & [Sneak]** - makes manual data unmanual.
- **[Shift] & [Update]** - shortcut to Save.
- **[Shift] & restore manual faders** - reset faders to zero without asserting control.
- **[Shift] & [Direct Select]** - posts DS to the command line without terminating.
- **[Sneak] [Sneak]** - releases NPs of selected channels and self terminates.
- **[Timing Disable] & [Go]** or **& [Back]** - cuts the next cue or cuts the last cue.
- **[Thru] [Thru]** - **[Thru]** command accesses only channels displayed in the current flexi-state (unless the range specified is NOT in the current display). **[Thru] [Thru]** selects the range regardless of the flexi mode.
- **[Trace] [Trace]** - forces a previously inactive light to track its new intensity setting backwards.
- **[Undo]** - clears an unterminated command line. Otherwise opens undo controls.
- **[Update] & [Sub Bump]** - to update a specific submaster.
- **[n] [At] [/] [/] [m] [Enter]** - sets direct DMX value (m) for channel (n).
- **[Shift] & [Delay] [Delay]** - posts hang to the command line.
- **[Shift] & [About]** - opens a command line search window.
- **[Shift] & [.]** - posts master only to the command line. This is for use with multicell fixtures.
- **[.]** - posts cells only to the command line when used after channel number(s). This is for use with multicell fixtures.
- **[Shift] & [Int Palette]** - posts preset on the command line. (Element)
- **[Displays] & [Record]** - puts a marker in the log file.

# Eos Family Hotkeys

To enable Eos functions on Mac Function keys:

- Open Systems Preferences
- Go into the Keyboard section
- Enable the “Use all F1, F2, etc... keys as standard function keys” setting.



**Note:** Some international keyboards require “Use Shift Key as Eos Shift” to be disabled in the General section of the ECU Settings. Use Z as shift to access shortcut functions in these cases.

Console Key	PC	Console Key	PC	Console Key	PC
Shortcut List	Alt /	Capture	Control Alt P		Control 3
	?	Clear	Backspace	Focus Filter	Control F
0	0	Clear Command Line	Shift Backspace	Focus Palette	Alt F
1	1		Control Alt Backspace	Follow/Hang	Shift D
2	2	Clear Label	Control Backspace		Control Alt D
3	3	Color Filter	Control C	Format	F4
4	4	Color Palette	Alt C		Control 4
5	5	Color Path	Control Alt W	(Scroller) Frame	Control Alt C
6	6	Copy To	C	Freeze	Control Alt F
7	7	Cue	Q	Full	F
8	8	Cue Only/Track	X	Go	Spacebar
9	9	Data	Control D	Go To Cue	Control G
. (decimal)	. (decimal)	Data Mode	Control Shift D	Go to Cue Zero	Control Alt G
- (minus)	- (minus)	Delay	D	Group	G
+(plus)	=	Delete	Delete	Help	Alt /
	+	Delete (Mac)	Fn Delete	Highlight	\
+%	Shift =	Displays	F9		Control Alt H
	Control Alt =		Control 9	Home	Home
		Effect	Alt E		Control H
-%	Shift -	Effects Softkeys	Alt Shift E	Home (Mac)	Fn Left Arrow
	Control Alt -	Encoder Display (Gio)	Control Alt \	Intensity Block	Shift B
		Encoder Page Color^	Control Alt [		Control Alt B
/	/	Encoder Page Focus^	Control Alt ,	Intensity Filter	Control I
About	Y	Encoder Page	Control Alt ;	Intensity	Alt I



		Form^		Palette	
Address/Dimmer	Alt A	Encoder Page Image^	Control Alt ]	Label / Note	L
All NPs	Control N	Encoder Page Intensity^	Alt .	Last	Page Up
Assert	Control W	Encoder Page Shutter^	Alt ,		Control ,
Assert (Playback)	Control Alt A	Enter	Enter	Last (Mac)	Fn Up Arrow
At	A	Escape	Escape	Learn	Alt L
	@	Expand	F5	Level	Control V
	*		Control 5	Live	F1
Beam Filter	Control B	Fader Page	V		Control 1
Beam Palette	Alt B	Fan	W	Load	Control Alt L
Blind	F2	FlexiChannel	F3	Macro	M
	Control 2			Macro 801*	Control Alt 1
Block	B			Macro 802*	Control Alt 2

Console Key	PC	Console Key	PC	Console Key	PC
Macro 803*	Control Alt 3	Record	R	Update	U
Macro 804*	Control Alt 4	RecordOnly	Control R	Virtual Keyboard	Control K
Macro 805*	Control Alt 5	Release	Control Alt S	Workspace	] or [
Macro 806*	Control Alt 6	Rem Dim	H		
Macro 807*	Control Alt 7	Scroll Lock	F6	<b>Shell Shortcut</b>	
Macro 808*	Control Alt 8		Control 6	<b>Shell Key</b>	<b>PC</b>
Macro 809*	Control Alt 9	Select	Control Enter	0	0
Macro 810*	Control Alt 0	Select Active	Control A	1	1
Magic Sheet	Alt M	Select Last	Control L	2	2
Manual Override	Control Alt M	Select Manual	Control M	3	3
	Control Alt N	Setup	Alt S	4	4
Mark	K	Shift	Z	5	5
Mirror, Start	Alt F1	Snapshot	Control S	6	6
Mirror, Stop	Alt F2	Sneak	N	7	7
ML Controls	F7	Softkey 1	Alt 1	8	8
	Control 7	Softkey 2	Alt 2	9	9
More Softkeys	Alt 7	Softkey 3	Alt 3	. (decimal)	. (decimal)
Next	Page Down	Softkey 4	Alt 4	- (minus)	- (minus)
	Control .	Softkey 5	Alt 5	+ (plus)	=
Next (Mac)	Fn Down Arrow	Softkey 6	Alt 6	/	/
Off	Control Alt O	Spacebar Disable	Alt G	Arrow, Down	Arrow, Down
Offset	Control O	Stop/Back	Control Space-	Arrow, Left	Arrow, Left

			bar		
Out	O		Control Alt Q	Arrow, Right	Arrow, Right
Page Left	Left Arrow	Stop Effect	Control Alt E	Arrow, Up	Arrow, Up
Page Right	Right Arrow		Control Alt K	Back	Esc
Page Up	Up Arrow	Submaster	S	Clear	Backspace
Page Down	Down Arrow	Tab	Tab	Delete	Delete
Parameters (Display)	Control D	Time	I	Enter	Enter
Park	Alt K	Time (Displays)	Shift I	Escape	Esc
Part	P		Control Alt I	Select	Return
Patch	::	Timing Disable	Control Alt T		
Pixelmap	Alt X	Toggle Hotkeys	F8		
Preset	Alt P		Control 8		
Query	Control Q	Trace	J		
Rate	Control Alt R	Thru	T		
Recall From	E	Undo	Control X		

\*Some Shortcut Key combinations are not available on all physical keyboard layouts.

^Alternatively use Encoder Display + category to change the encoder pages.

# Index

-	
-%	193
.	
.csv	
exporting	101
importing	99
+	
+%	193
<b>A</b>	
about	
about	366
channel	369, 371
color path	375
cue	373
cuelist	373
curves	374
display	367
effects	374
groups	374
macro	375
palettes	375
presets	375
Sensor feedback	371
submaster	374
system	368
what's new	367
absolute data	
with palettes	225
absolute effects	335
accessories	
patching	112
ACN	504
sending	507, 509
actions	
analog inputs	494

active cue list	
changing	290
address	5, 200
OSC	531
parking in live	351
address check	200
allfade	264, 290
analog inputs	476, 493
actions	494
cues	494
events	493
macros	494
submasters	494
aRFR	465
ASCII	
exporting	101
importing	99
assert	9
and load	312
at channel level	290
at cue level	289
cue list	312
flags	264
using with cue lists	289
At //	176
At Enter	266
AutoMark	216
allowing live moves	216
timing	217

## B

background (softkey)	
in cue list index	280
backup	441, 448
backup console	442
client	442
master	442

offline console .....	442	button overlays	
primary .....	442	See button module. ....	13
backup console		buttons	
definition .....	442	configuration .....	472
basic manual control .....	170	by type palettes .....	225, 233
beam palette		editing in blind .....	233
description .....	225	updating .....	234
OSC .....	534	by type presets .....	236
blackout .....	22, 312	updating .....	243
blind .....	9	using .....	242
configuration menu .....	57		
display indicators .....	52	<b>C</b>	
editing cues in .....	271	calibrate scroller .....	120
editing palettes in .....	230	capture .....	299
editing presets in .....	240	Central Information Area (CIA) .....	30
recording cues in .....	271	browser .....	33
spreadsheet view .....	51	favorite display .....	31
edit palettes in .....	231	locking .....	31
storing multipart cues in .....	320	parameter display .....	32
text indicators .....	56	parameter display in .....	175
using encoders in .....	274	unlocking .....	31
block .....	9, 263	virtual keypad .....	86
channels/parameters .....	263	channel .....	4
cues .....	263	delete .....	110
break nested references		groups .....	209
with [Update] .....	267	OSC .....	521
browser .....	33	swapping .....	110
clear .....	34	unpatching .....	110
file		channel check .....	200
save as .....	98	channel faders .....	170
Image .....	33	channels	
navigating within .....	33	asserting .....	290
virtual keypad .....	86	deselecting .....	174
bump button		display conventions .....	53
timing .....	361	homing .....	189
button module		moving .....	109
description .....	13	multiple intensity .....	190
installation .....	14	ordered with groups .....	204
		selecting .....	170
		using about .....	369, 371

CIA. See Central Information Area .....	30	configuration utility .....	451, 471
clear		console	
command line .....	31	capacities .....	26
cue attributes .....	262	cleaning .....	26
filters .....	285	geography .....	12-16
patch .....	133	conventional fixtures	
submaster .....	364	display conventions .....	53
clear functions .....	34	copy	
clear patch .....	35	fixture .....	147
clear show .....	35	copy to .....	294
patch 1 to 1 .....	35	palettes .....	233
reset system .....	35	presets .....	240
client console		create	
definition .....	442	cue .....	250
closing		cue list .....	288
displays .....	41	curve .....	379
color		fixture in patch .....	133
OSC .....	523	group .....	204
color control		macro	
from encoders .....	181	using editor display .....	393
gel picker .....	185	new fixture .....	134
spectrum tools .....	188	new multicell fixture .....	145
tinting tools .....	186	palette .....	225
color effects .....	341	preset .....	236
color indicators		submaster .....	354
in live/blind .....	55	cue	
color palette		OSC .....	534, 539
description .....	224	preserve blind .....	161
OSC .....	534	cue level timing	
color path .....	187	setting .....	255
using {About} .....	375	cue list index .....	275
color picker .....	182	{Background} .....	280
color spaces .....	182	{edit} .....	277
command history .....	302	{Solo Mode} .....	276
command line .....	164	opening .....	275
about .....	31	cue lists	
syntax structure .....	5	{assert} & {load} .....	312
Compression		about multiple .....	288
saving .....	98	active list, changing the .....	290

fader and button .....	281	fanning time .....	213
go after loop .....	266	flags .....	263
new, recording to		allfade .....	264
using {Record Only} .....	289	assert .....	264
using {Record} .....	288	block .....	263
OSC .....	536	mark .....	264
out of sequence sync .....	265	preheat .....	264
ownership .....	8	go to cue .....	307
properties .....	278	modifying	
record via load .....	288	from spreadsheet view .....	273
recording to new .....	288	from summary view .....	272
using {About} .....	373	from table view .....	272
using assert .....	289	using {move to}	
Cue Only mode .....	6	in blind .....	274
deleting cues in .....	275	using {Record} .....	267
cue playback .....	303	using {Replace With} .....	273
cue settings		using {Update} .....	267
in setup .....	151	using At Enter .....	266
cues .....	6	using Record Only .....	267
about .....	250	modifying in live .....	266
analog inputs .....	494	multipart	
applying curves to .....	380	about .....	318
asserting .....	289	changing to .....	320
At Enter .....	266	changing to a standard cue .....	320
attributes .....	257	deleting a part .....	321
clearing .....	262	setting part attributes .....	319
follow/hang .....	258	numbering .....	250
label .....	260	out of sequence .....	306
link/loop .....	258	using go to cue .....	307
rate .....	260	part. See cues - multipart .....	318
basic programming .....	250	recently activated .....	291
block .....	263	recording	
cue list index .....	275	using Record .....	251
opening .....	275	using Record Only .....	251
deleting .....	274	recording an effect .....	345
in Cue Only mode .....	275	recording in blind .....	271
in Track mode .....	275	recording in live .....	250
editing in blind .....	271	recording multipearts in live .....	318
external links .....	265		

selected, the		customizable hardkeys;hardkeys	
in blind	305	customizable	24
in live	305		
settings		<b>D</b>	
in setup	151	data (navigation key)	48
storing		database settings, in patch	126
selective	253	Default About	
using Cue Only/Track		Parameters	367
in Cue Only mode	253	delay	
in Track mode	252	effects	347
storing multipearts in blind	320	delay timing	257
timing	254	delete	
delay	257	channel	110
discrete	256	cues	274
manual	255	curves	381
parameter category	256	folder	102
setting	255	groups	208
updating		macros	395
to references	268	palettes	234
without references	269	parts from multipart cues	321
updating multipearts in live	319	presets	243
using About	373	show file	102
using Allfade	290	snapshots	387
curves		submasters	364
about	378	delete a channel	110
applying		desk lamps	25
to channels in patch	380	dimming	25
to cues	380	dimmer	
clearing	380	See address.	351
creating	379	dimmer check	
delete	381	See Address Check	200
editing	379	dimmer doubling	
in patch	125	in patch	108
OSC	536	direct selects	
scroller fan	120	flexi mode	73
using about	374	OSC	527, 540
custom control		scenes	72
from encoders	181	selecting channels with	68, 173
custom fixture	147	shift	73
		storing palettes to	227

discrete timing .....	256
display	
indicators	
mark .....	218
display indicators .....	52
displays	
attribute, in patch .....	124
changing format .....	48
closing .....	41
color indicators .....	55
controlling .....	41
database, in patch .....	126
effect status .....	329
expanding .....	45
macro editor .....	391
moving .....	46
navigating .....	41
opening .....	41
from the browser .....	41
from the hardkeys .....	41
from the home screen .....	41
from the softkeys .....	41
parameter .....	32
park	
parking from .....	351
patch	
opening .....	105
settings .....	123
playback status	
color indicators .....	65
Image .....	60
indicators in .....	64
text indicators .....	65
scrolling within .....	45
selecting .....	46
spreadsheet view .....	51
summary data view .....	48
table view .....	49
zooming .....	46

DMX	
outputting .....	26
value on command line .....	176

## E

edit (softkey)	
in cue list index .....	277
editing	
cues in blind .....	271
curves .....	379
effect	
live .....	343
from submaster list .....	355
groups	
from group list index .....	209
groups in live .....	207
macros .....	393
palettes in blind .....	230
palettes in live .....	229
palettes in spreadsheet view .....	231
parameters in new fixture .....	134
presets .....	239
in spreadsheet view .....	241
in table view .....	241
presets in blind .....	240
ranges for new fixture .....	137
scroller in patch .....	119
snapshots .....	386
wheel in patch .....	119
effect	
delaying .....	347
effects	
about .....	324
absolute .....	335
programming .....	336
applying an existing .....	343
color .....	341
cue .....	345
editing	
live .....	343



focus .....	340	ETCnomad	
linear .....	341	fullscreen editor .....	455
multiple intensity HTP .....	340	ethernet ports .....	25
OSC .....	536	events .....	484
relative .....	340	analog inputs .....	493
color .....	341	event list .....	485-486
defining a pattern .....	341	MIDI .....	514-515
focus .....	340	MIDI note off .....	511, 516
linear .....	341	MIDI note on .....	511, 515
programming .....	342	MIDI program change .....	513, 517
status display .....	329	Real Time Clock .....	491
step .....	332	expanded timeline format .....	62
programming .....	333	expanding displays .....	45
stopping .....	343	export	
submasters .....	345	.csv .....	101
using {Stop Effect} .....	313	ASCII .....	101
using about .....	374	Fast Focus Pro .....	101
element 2		logs .....	101
geography .....	18	Moving Light Assistant .....	101
encoders .....	23	show file .....	101
about .....	73	external links .....	265
blind .....	76	removing .....	266
color control .....	181		
custom control .....	181	<b>F</b>	
flexi .....	77	facepanel	
image control .....	180	locking .....	35
locking .....	77	fader pages .....	310
navigating .....	76	Fader Status Display .....	80
setting non-intensity parameters .....	176	faders	
shutter control .....	180	assigning .....	309
softkeys .....	178	auto playback enabled .....	309
touchscreen .....	74	manually .....	309
description .....	177	changing pages .....	22, 310
form control .....	179	channel .....	170
Image of .....	177	channel filters .....	84
using in blind .....	274	configuration .....	78
enter (key)		control buttons .....	22
using in syntax .....	5	list .....	80
		motorized .....	25
		palettes .....	229, 244

parameter filters .....	84	mark .....	264
playback controls .....	310, 313	flash .....	200
presets .....	244	flash off .....	201
rate override .....	313	flash on .....	201
release .....	315	flexichannel	
ribbon .....	81	description .....	59
status display (Element) .....	80	multicell .....	59
temporary mapping .....	247	partitioned .....	440
virtual module .....	85	patch views .....	106
fan .....	212	flip .....	179
from the command line .....	212	focus effects .....	340
parameter data .....	212	focus palette	
references .....	213	description .....	224
timing .....	213	OSC .....	533
Fast Focus Pro		Focus Track	
exporting .....	101	exporting .....	101
file		folder	
create new show .....	90	deleting .....	102
file manager .....	102	follow .....	258
filters		form control .....	179
about .....	284	format	
channel and parameter on faders .....	84	changing .....	48
partial filters .....	284	summary data view .....	48
record filters .....	284	frames .....	37
storing data with .....	285	freeze .....	313
removing .....	285	fullscreen offline editor .....	455
using with palettes .....	228	fuse .....	12
fixture .....	4		
fixture creator		<b>G</b>	
update profile .....	133	gel picker .....	185
fixture editor .....	133	global effect fader .....	346
opening .....	134	go (key)	
fixture library		in playback .....	311
updating in show file .....	133	go after loop .....	266
flags .....	263	go to cue .....	307
allfade .....	264	with multiple cue lists .....	291
block .....	263	Go To Cue	
channels/parameters .....	263	timing .....	307
cues .....	263	go to cue 0	
		& [Load] .....	312

command line .....	291
playback button .....	312
go to cue out .....	292
gobo	
importing;import	
gobo .....	101
grandmaster .....	22
configuration .....	82
group	
OSC .....	531
group list index .....	208
editing from .....	209
opening .....	208
using [Format] in .....	208
groups	
about .....	204
channel collector .....	171, 209
deleting .....	208
editing	
from the group list index .....	209
editing in live .....	207
group list index	
opening .....	208
numeric view .....	208
ordered channels .....	204
ordered view .....	208
recalling .....	208
recording in live .....	204
recording with offset .....	205
selecting .....	208
subgroups .....	205
updating in live .....	207
using about .....	374

## H

hang .....	258
help system	
description .....	3
high See highlight .....	196

highlight .....	196
rem dim .....	197
temporary level .....	197
home (hardkey) .....	189
encoder softkey .....	178
HTP .....	9

## I

image control	
from encoders .....	180
import	
.csv .....	99
ASCII .....	99
custom fixture .....	147
Lightwright .....	99
show file .....	99
indicators	
in playback status display .....	64
indicators in live/blind .....	52
install button modules .....	14
intensity	
manual override in playback .....	315
set with level wheel .....	175
setting .....	174
-% .....	193
+% .....	193
intensity palettes	
description .....	224
OSC .....	533
IO Gateway	
receiving via .....	506
sending via .....	510
iRFR .....	465

## K

keypad .....	22
navigation .....	22
selecting channels with .....	171
setting parameters with .....	176
keys	
backlit .....	22

keywords	
adding in patch	126
<b>L</b>	
label	33
cue	260
editing	33
submasters	361
lamp controls	143, 192
last (key)	171
LCD touchscreens	21
learn (key)	390
LEDs	
patching	112
level wheel	23
setting intensity with	175
Lightwright	
importing	99
linear effects	341
link/loop	258
list view	
group	208
palettes	232
presets	239
opening	239
submaster	
editing from	355
opening	355
Littlites	25
dimming	25
live	9, 200
configuration menu	57
display indicators	52
editing effects in	343
editing groups in	207
editing palettes in	229
editing presets in	239
modifying cues in	266
park	350
parking addresses in	351

preview mode	50
recording cues in	250
recording multipart cues in	318
storing macros in	390
storing presets in	236
text indicators	56
updating groups in	207
updating multipart cues in	319
load	
buttons	24
partial show	91
submaster	361
lock icon	31
locked palettes	225
locking	
facepanel	35
loop	258
low See lowlight	196
lowlight	196
preset	196
LTP	10

## M

macro editor display	391
macros	
about	390
analog inputs	494
create new	
using editor display	393
deleting	395
editing	393
editor display	391
modes	392
OSC	532
playing	394
stopping	395
storing in live	390
using {About}	375
using {Learn}	390

magic sheets	
about	398
array	405
backgrounds	410
creating	402
display	398
display tools	400
editing	402
editing objects	417
examples of	418
fixture symbols	409
importing fixture symbols	410
importing icons	410
importing images	410
keyboard shortcuts	402
layout tools	403
list	399
multi-touch gestures	402
navigating	401
object library	407
object properties	414
objects	408
OSC	531
popup	47, 161
quick save	403
targets	414
make manual	
about	298
with multiple cue lists	289
make null	
about	297
managing show files	89
manual control	
[last]	171
[next]	171
address check	200
advanced	293
capture	299
copy to	294
query	300
recall from	295
button modules	
selecting channels with	173
channel check	200
controlling non-intensity parameters (NPs)	175
encoder touchscreen	177
flash	200
flip	179
highlight	196
home (hardkey)	189
lowlight	196
make manual	298
make null	297
offset	172
remainder dim	194
selecting channels	170
setting intensity	174
setting lamp controls	192
settings see setup.	160
sneak	197
submasters	362
timing	
manual, for cues	255
manual data	8
manual override (key)	315
in playback	315
mark	
about	216
allowing live moves	216
AutoMark	216
AutoMark timing	217
display indicators	218
earliest	219
flag	218, 264
priority	218
referenced marks	217
removing referenced marks	221
setting referenced mark flags	217

symbols .....	219	mirror mode .....	448
timing, referenced marks .....	220	ML Controls .....	77
mark time .....	152, 221	popup .....	47
master console		virtual control .....	77
definition .....	442	mode .....	139
master playback controls .....	23	monitors	
merge		external .....	21
.esf .....	93	move fade .....	8
channel .....	95	move instruction .....	8
show file .....	93	move to	
MIDI .....	476	about .....	295
command interpretation .....	499	in patch .....	109
control change events .....	514, 517	move to (softkey)	
Device ID .....	499	with cues in blind .....	274
event .....	514-515	moving displays .....	46
event list .....	515	Moving Light Control .....	77
fire .....	500	moving lights	
go .....	499	display conventions .....	53
hexadecimal .....	501	patching .....	112
note off event .....	511, 516	multicell	
note on event .....	511, 515	display conventions .....	54
program change event .....	513, 517	editing .....	115
raw .....	511	in groups .....	207
raw cues .....	517	manual control .....	190
raw macros .....	518	new .....	145
raw string .....	518	patching .....	113
raw subs .....	517	multiconsole .....	441, 446
receiving .....	511	features of .....	444
resume .....	500	multipart cues .....	317
sending .....	517	about .....	318
set .....	500	attributes	
show control .....	499	setting .....	319
stop .....	500	changing into standard cues .....	320
strings .....	511	changing standard cues into .....	320
system events .....	514	recording in live .....	318
MIDI Notes .....	476	storing in blind .....	320
MIDI Raw .....	476	updating in live .....	319
MIDI Strings .....	476	multiple intensity channels .....	190
MIDI time code .....	476	multiple intensity HTP effects .....	340

multiple users .....421, 444

## N

navigating

encoders .....76

navigation keys

{data} .....48

{time} .....47

next (key) .....171

non-intensity parameters (NPs)

controlling .....175

setting

- .....176

-% .....193

+ .....176

+% .....193

setting with encoders .....176

NPs. See non-intensity parameters .....175

numbering

cues .....250

numeric view

groups .....208

## O

offline console

definition .....442

offset .....172

channels in groups .....205

in patch .....111

online forums

register for .....2

OOS Sync .....265

open

fixture editor .....134

Open Sound Control .....519

opening

displays .....41

from the browser .....41

from the hardkeys .....41

from the home screen .....41

from the softkeys .....41

partial show .....91

ordered channels .....204

ordered view

groups .....208

OSC .....476, 519

absolute levels .....522

active channel .....539

active cue .....539

active parameter .....526, 539

address .....531

app .....544, 546, 548

beam palette .....534

channel .....521

color .....523

color palette .....534

command line .....537, 539

configuring .....519

cue .....534

cue list .....536

curve .....536

direct selects .....527, 540

effect .....536

Eos keys .....530, 559

explicit output .....538

fader banks .....529, 540

focus palette .....533

gel .....544

group .....531

implicit output .....539

intensity palette .....533

list convention .....543

local .....520

macro .....532

magic sheet .....531

misc console events .....540

other .....538

ping .....520

pixel map .....536

preset .....533

settings .....	539	focus .....	224
show control events .....	540	intensity .....	224
show file information .....	540	list indicators .....	232
snapshot .....	536	list view .....	232
softkey .....	536	locked .....	225
submaster .....	532	on faders .....	229, 244, 247
subscribe .....	527	options .....	225
supported input .....	521	re-recording .....	230
switch .....	525	recalling .....	228
synchronize app .....	544	selective storing	
TCP .....	519	using {Record} .....	226
troubleshooting .....	558	storing .....	225
UDP .....	520	to direct selects .....	227
UID .....	543	using {Record only} .....	227
user .....	537	using {Record} .....	226
using .....	519	types of .....	224
wheel .....	524	updating .....	230
out		using about .....	375
go to cue .....	292	parameter category timing	
out of sequence cues .....	306	setting .....	256
using go to cue .....	307	parameter display	
out of sequence sync .....	265	about .....	175
<b>P</b>			
paging		parameters .....	6
encoders .....	76	categories .....	6, 24
faders .....	310	display .....	32
softkeys .....	36	display in CIA .....	175
palettes		homing .....	189
about .....	224	OSC .....	526
as absolute data .....	225	setting	
beam .....	225	keypad, using .....	176
by type .....	225, 233	snap .....	144
color .....	224	Parameters .....	367
copy to .....	233	park	
deleting .....	234	about .....	350
editing in blind .....	230-231	addresses in live .....	351
spreadsheet view .....	231	buffer .....	93
editing in live .....	229	display	
filters .....	228	parking from .....	351
		in live .....	350



recall from .....	296	quick action .....	138
scaled .....	351	quick label .....	139
part. See multipart cues .....	318	save fixture;save fixture .....	145
partial filters .....	284	scroller picker .....	116
partial show loading .....	91	search .....	112
partitioned control .....	438	settings .....	123
about .....	438	swapping channels .....	110
create partitions .....	438	unpatch a channel .....	110
partition list .....	438	wheel picker .....	116
selecting partitions .....	438		
setup .....	438	ping	
using partitions .....	439	OSC .....	520
patch .....	103	pixel map	
accessories .....	112	OSC .....	536
adding keywords .....	126	playback	
applying curves in .....	380	fader controls	
assigning curves in .....	125	assert .....	312
attribute display .....	124	freeze .....	313
clear .....	133	manual override .....	315
database display .....	126	rate override .....	313
deleting a channel .....	110	release .....	315
dimmer doubling .....	108	stop effect .....	313
display .....	105	timing disable .....	312
Image .....	123	intensity	
editing		manual override .....	315
scrollers .....	116	out of sequence cues .....	306
wheels .....	116	using {Go} .....	311
editing multicell fixtures .....	115	using {stop/back} .....	311
editor .....	117	using go to cue .....	307
fixture editor .....	133	playback status display .....	63
LEDs .....	112	color indicators .....	65
mode .....	139	configuration .....	66
move to .....	109	expanded timeline format .....	62
moving channels .....	109	Image .....	60
moving light .....	112	indicators .....	64
multicell fixtures .....	113	text indicators .....	65
offset, using .....	111	playing macros .....	394
picker .....	116	power	
preheat .....	124	powering down .....	30
		powering up .....	30

power button .....	20	protocols .....	463
preheat		ACN .....	463
cue flag .....	264	ArtNet .....	464
in patch .....	124	Avab UDP .....	464
preserve blind cue .....	161		
preset		<b>Q</b>	
OSC .....	533	query .....	300
presets		adding keywords to channels .....	126
about .....	236	quick access .....	47
absolute .....	236	quick action .....	138
by type .....	236	quick label .....	139
copy to .....	240	quick save	
deleting .....	243	magic sheets .....	403
editing in blind .....	240		
spreadsheet view .....	241	<b>R</b>	
table view .....	241	Radio Focus Remote (RFR)	
editing in live .....	239	in ECU .....	472
effects .....	238	USB settings .....	472
list indicators .....	239	WiFi	
list view .....	239	iRFR .....	465
opening .....	239	range editing new fixtures .....	137
locked .....	236	rate .....	22
move to .....	240	cue attribute .....	260
on faders .....	244, 247	rate override .....	313
options .....	236	RDM	
recalling .....	238	device details .....	372
removing channels from .....	234, 243	Real Time Clock .....	476, 491
rerecording .....	239	enabling .....	491
storing		events .....	491
using {Record Only} .....	237	programming .....	491
using {Record} .....	237	recall from .....	295
storing in live .....	236	park .....	296
updating .....	239	record	
using about .....	375	cue list .....	288
primary console		using {Record Only} .....	289
definition .....	442	using {Record} .....	288
print		cues	
show file .....	95	in live .....	250
		using Record .....	251
		using Record Only .....	251
		cues in blind .....	271

filters, with	284	Remote Video Interface (RVI)	
groups live	204	button configuration	472
multipart cues	318	remove	
attributes	319	channels	
new cue list	288	from presets	234, 243
using {Record Only}	289	referenced mark	221
using {Record}	288	replace	108
palettes	225	replace with	273
with selective store	226	rerecord palettes	230
partial filters, with	284	RS232	476, 504
presets	236	sending	507
snapshots	384		
submasters	354	<b>S</b>	
via load	288	sACN	
record defaults		input	476, 497
setting	159	using	497
record filters		sACN output viewer	86
storing data with	285	save as	98
record target	6	saving	
reference labels	48	compression	98
referenced marks	217	existing show file	97
setting flags	217	scaled park	351
timing	220	scene	261-262
register your console	2	scroller	
relative effects	340	calibrating	120
relay outputs	476, 496	calibrating via ML Controls	120
release	315	calibration column	121
Release	197	editing in patch	119
Release. See Sneak	197	fan curves	120
rem dim. See remainder dim	194	scroller fans	
remainder dim	194	applying curves to	381
highlight	197	scroller picker	116
proportional value	195	scrolling displays	45
remote power off	448	select active	199
remote power on	448	minus	199
Remote Processor Unit (RPU)		select all	199
button configuration	472	select channels	
remote software installation	448	direct selects	173
		keypad	171
		select last	198

select manual .....	199	show file	
minus .....	199	create .....	90
selecting		deleting .....	102
displays .....	46	exporting .....	101
selective store		importing .....	99
negative .....	254	loading parts of .....	91
positive .....	253	managing .....	90
with cues .....	253	merging .....	93
Sensor feedback		name	
about .....	371	bold .....	90
enable .....	465	normal .....	90
serial		new .....	90
ACN .....	504, 506-507	open existing .....	90
enabling .....	504	print .....	95
programming events .....	507	save as .....	98
receiving .....	504, 506	saving existing .....	97
RS232 .....	504, 506-507	show setup	
sending .....	507, 509	{system} .....	150
UDP .....	504, 506-507	shutter control	
settings		from encoders .....	180
attribute, in patch .....	124	SMPTE .....	476
database, in patch .....	126	snap parameters .....	136, 144
patch .....	123	snapshots	
setup .....	149	about .....	384
desk settings		delete .....	387
face panel .....	162	edit .....	386
manual control .....	160	OSC .....	536
record defaults .....	159	popup .....	47
device settings		recall .....	386
displays .....	164	record .....	384
opening .....	150	sneak	
show settings		description .....	197
cue settings .....	151	softkeys .....	35
system .....	150	changing pages .....	36
show control		OSC .....	536
additional resources .....	4	solo mode (softkey)	
capabilities .....	541	in cue list index .....	276
display .....	484	split .....	63

spreadsheet view .....	51	manual control .....	362
editing palettes in .....	231	OSC .....	532
editing presets in .....	241	properties .....	355
modifying cues from .....	273	recording .....	354
modifying using {move to} .....	274	updating .....	364
modifying using {replace with} .....	273	using {About} .....	374
step effects .....	332	summary view .....	48
stop effect .....	313	modifying cues from .....	272
storing		swapping channels .....	110
palettes		synchronized backup .....	446
using {Record Only} .....	227	setup .....	446
using {Record} .....	226	syntax	
palettes to direct selects .....	227	structure .....	5
presets		using enter .....	5
using {Record Only} .....	237	system	
using {Record} .....	237	using about .....	368
using record filters .....	285		
string interface		<b>T</b>	
ACN .....	504, 506	tab .....	38
OSC .....	504	numbers .....	38
receiving ACN .....	505	tools .....	40
RS232 .....	504	table view .....	49
sending .....	508	editing presets in .....	241
sending from macros .....	509	modifying cues from .....	272
UDP .....	504	text indicators	
Subgroups .....	205	in live/blind .....	56
Groups .....	205	in playback status display .....	64
submasters		time	
about .....	354	bump buttons .....	361
analog inputs .....	494	cue	
bump button timing with .....	361	setting .....	255
clearing .....	364	cues .....	254
deleting .....	364	delay .....	257, 259
effects .....	345	disable in playback .....	312
execute list .....	362	discrete .....	256
fader and button .....	359	Go To Cue .....	307
list .....	355	manual control of, in playback .....	314
editing from .....	355	setting for parameter categories .....	256
loading .....	361	time / .....	256
		time (navigation key) .....	47



pixel map .....	424
pixel mapping multi-console system .....	434
working with .....	424, 426

## W

what's new	
using {About} .....	367
wheel	
OSC .....	524
wheel picker .....	116
working with a single cue list .....	249
working with multiple cue lists .....	287
workspaces .....	37



Corporate Headquarters Middleton, WI, USA +1 608 831 4116 London, UK +44 (0)20 8896 1000  
Holzkirchen, DE +49 (80 24) 47 00-0 Rome, IT +39 (06) 32 111 683 Hong Kong +852 2799 1220 Paris, FR +33 1 4243 3535  
Web [etccconnect.com](http://etccconnect.com) Support [support.etccconnect.com](http://support.etccconnect.com) Contact [etccconnect.com/contactETC](http://etccconnect.com/contactETC)  
© 2019 Electronic Theatre Controls, Inc. Trademark and patent info: [etccconnect.com/ip](http://etccconnect.com/ip)  
Product information and specifications subject to change. ETC intends this document to be provided in its entirety.  
4250M1210-2.9.0 Rev A Released 2019-08



## END USER LICENSE AGREEMENT (“EULA”)

PLEASE READ THE FOLLOWING CAREFULLY BEFORE OPERATING/INSTALLING THE SOFTWARE. BY OPERATING/INSTALLING THE SOFTWARE, YOU WILL BE DEEMED TO HAVE ACCEPTED AND AGREED TO THE TERMS OF THIS AGREEMENT. THE SOFTWARE IS LICENSED AND COPYRIGHTED (NOT SOLD).

Subject to the following terms and conditions, Electronic Theatre Controls, Inc. (“ETC”) grants to you (“User”), a non-exclusive license to use the Software.

### 1. **Grant of License**

This is a worldwide, royalty-free, non-exclusive license granted to User subject to and in accordance with the terms and conditions of this Agreement. ETC intends to provide, but does not guarantee, updates or upgrades of the Software. ETC will provide maintenance and support relating to the Software. The Software may not be transferred, sold, assigned, leased, rented, sublicensed, or otherwise conveyed, in whole or in part, by User to any third party without ETC’s prior written consent.

You have acquired a device (“Device”) which includes software licensed by ETC from one or more software licensors. The Software is licensed, not sold. You may use the Software only on the Device.

### 2. **ETC’s Software Rights**

The Software is a proprietary product of ETC and is protected under all applicable copyright laws and international treaties. Except for the limited license granted herein, all right, title and interest to and in the Software remains forever with ETC.

### 3. **Additional Restrictions**

User may not modify, distribute, rent, lease, or sell the Software, but User may transfer User’s rights under this License on a permanent basis provided User transfers this License, together with the accompanying Software, and all other relevant materials, retaining no copies and the recipient party agrees to the terms of this License. User agrees not to cause or permit the reverse engineering, disassembly, or decompilation of the Software. Removal, emulation, or reverse engineering of all or any part of the Software constitutes an unauthorized modification to the Software and is specifically prohibited. If the Software is licensed to a User for use in a member country of the European Union, User may reverse engineer and/or decompile the Software to the extent that sufficient information is not available for the purpose of creating an interoperable software program and cannot be obtained by observing, examining or testing the program (but only for such purposes and to the extent that sufficient information is not provided by ETC upon written request). User shall not remove any product

identification, copyright notices, or other notices or proprietary restrictions from the Software.

#### **4. Warranty Information**

Software is provided “AS IS” under this License, without warranty of any kind, either express or implied, including, without limitation, warranties that the Software is free of defects, merchantable, fit for a particular purpose or non-infringing. The entire risk as to the quality, operation, and performance of the Software is with User. Should any Software prove defective in any respect, User assumes the cost of any necessary servicing, repair or correction. This disclaimer of warranty constitutes an essential part of this license.

#### **5. Upgrades**

If this copy of the Software is an upgrade from a previous version of the Software, it is provided to you on a license exchange basis. You agree by your installation and use of such copy of the Software to voluntarily terminate your earlier Agreement and that you will not continue to use the earlier version of the Software or transfer it to another person or entity.

#### **6. Third-Party Software**

The Software may contain third-party software not owned by ETC which requires notices and/or additional terms and conditions. Such notices and/or terms and conditions may be obtained by contacting your ETC sales rep and are made a part of and incorporated by reference into this Agreement. In addition, certain copyrights notices for such third party software also are included in the documentation attached hereto. By accepting this Agreement, you are also accepting the additional notices and terms and conditions, if any, set forth elsewhere.

#### **7. U.S. Government Restricted Rights**

The Software and any documentation were developed at private expense, are commercial, and are published and copyrighted. The Software and any documentation may be transferred to the U.S. Government only with the prior written consent of an officer of ETC. The Software and documentation are provided with RESTRICTED RIGHTS. Use, duplication or disclosure by the U.S. Government or any person or entity acting on its behalf is subject to restrictions as set forth in subdivision (c)(1)(ii) of the Rights in Technical Data and Computer Software Clause at DFARS (48 CFR 252.227-7013) for DoD contracts, in paragraphs (c)(1) and (2) of the Commercial Computer Software-Restricted Rights Clause in the FAR (48 CFR 52.227-19) for civilian agencies, or in the case of NASA, in Clause 18-52.227-86(d) of the NASA Supplement to the FAR, or in other comparable agency clauses. The contractor or manufacturer is Electronic

Theatre Controls, Inc., 3031 Pleasant View Road, Middleton, Wisconsin, USA, 53562-0979.

#### **8. Limitation of Liability**

UNDER NO CIRCUMSTANCES AND UNDER NO LEGAL THEORY, WHETHER TORT (INCLUDING NEGLIGENCE), CONTRACT OR OTHERWISE, SHALL ETC BE LIABLE TO ANY PERSON OR ENTITY FOR ANY INDIRECT, SPECIAL, INCIDENTAL, OR CONSEQUENTIAL DAMAGES OF ANY KIND INCLUDING, WITHOUT LIMITATION, DAMAGES FOR LOSS OF GOODWILL, WORK STOPPAGE, COMPUTER FAILURE OR MALFUNCTION, OR ANY AND ALL OTHER COMMERCIAL DAMAGES OR LOSSES, EVEN IF SUCH PARTY SHALL HAVE BEEN INFORMED OF THE POSSIBILITY OF SUCH DAMAGES. THIS LIMITATION OF LIABILITY SHALL NOT APPLY (I) TO DEATH OR PERSONAL INJURY RESULTING FROM SUCH PARTY'S NEGLIGENCE TO THE EXTENT APPLICABLE LAW PROHIBITS SUCH LIMITATION, (II) FOR CONSUMERS WITH RESIDENCE IN A MEMBER COUNTRY OF THE EUROPEAN UNION (A) TO DEATH OR PERSONAL INJURY RESULTING FROM ETC'S NEGLIGENCE, (B) TO THE VIOLATION OF ESSENTIAL CONTRACTUAL DUTIES BY ETC, AND (C) TO DAMAGES RESULTING FROM ETC'S GROSS NEGLIGENT OR WILLFUL BEHAVIOR. SOME JURISDICTIONS DO NOT ALLOW THE EXCLUSION OR LIMITATION OF INCIDENTAL OR CONSEQUENTIAL DAMAGES, SO THIS EXCLUSION AND LIMITATION MAY NOT APPLY TO YOU.

#### **9. Export Administration**

The Software, including technical data, are subject to U.S. export control laws, including without limitation, the U.S. Export Administration Act and its associated regulations, and may be subject to export or import regulations in other countries. User shall not directly or indirectly export or re-export the Software, or the direct product thereof, without first obtaining ETC's written approval. User agrees to comply with all regulations and acknowledges that it has the responsibility to obtain licenses to export, re-export, or import the Software. The Software may not be downloaded or otherwise exported or re-exported (i) into, or to, any country to which the U.S. has embargoed goods, or to a national or resident thereof; or (ii) to anyone on the U.S. Treasury Department's list of Specially Designated Nationals and Blocked Persons List; or (iii) to any country facing U.S. sanctions, as listed by the U.S. Treasury Department's Office of Foreign Assets Control.

#### **10. Termination**

Notwithstanding the above, ETC may, without prejudice to any other rights or remedies, terminate this EULA, if any of the following events should occur: (i) if you fail to perform or comply with any provision or term herein; and (ii) if you become insolvent, go into liquidation, file or initiate an action for bankruptcy, or have a receiver, administrative receiver or liquidator appointed or suffer similar

measures in any relevant jurisdiction; or if you cease doing business in any form or are no longer able to meet your obligations within the meaning of this EULA.

**11. Confidentiality**

You shall keep secret and confidential and shall not disclose to any third party any and all confidential information owned or otherwise possessed by ETC including without limitation the Software, the related documents and the contents of this EULA without prior written approval from ETC.

**12. Ownership**

ETC and its licensors shall retain exclusive ownership of all world-wide intellectual property rights in and to the Software and any copies of the Software. All rights in and to the Software not expressly granted to User in this EULA are expressly reserved for ETC and its licensors.

**13. Warranty for Third Party's Intellectual Property Rights**

You shall indemnify, defend and hold harmless ETC and the Supplier (or Suppliers, as applicable) from and against any and all losses, damages, claims, liability, costs and expenses (including reasonable attorney fees), suffered or incurred by ETC or the Supplier as a result of any claim by any third party that by reason of your use or application of any intellectual property right contained in the Software constitutes an infringement of any third party's property rights, including but not limited to, patent and copyright.

**14. Destruction of the Software**

Upon termination of this EULA, you must destroy the Software, the related documents and any and all copies thereof within ten (10) days after the date of termination and submit documents evidencing such destruction to ETC.

**15. Miscellaneous**

A) Complete Agreement: This Agreement is the complete agreement between the parties with respect to the Software and supersedes any other communication, written or verbal, with respect to the Software.

B) Severability: The provisions of this EULA are severable; if any term or provision shall be deemed void or unenforceable by a court of competent jurisdiction, such declaration shall have no effect on the remaining terms and provisions hereof.

C) Governing Law: This Agreement shall be governed by the laws of the State of Wisconsin, USA.

## The Artistic License

### Preamble

The intent of this document is to state the conditions under which a Package may be copied, such that the Copyright Holder maintains some semblance of artistic control over the development of the package, while giving the users of the package the right to use and distribute the Package in a more-or-less customary fashion, plus the right to make reasonable modifications.

### Definitions:

- \* "Package" refers to the collection of files distributed by the Copyright Holder, and derivatives of that collection of files created through textual modification.

- \* "Standard Version" refers to such a Package if it has not been modified, or has been modified in accordance with the wishes of the Copyright Holder.

- \* "Copyright Holder" is whoever is named in the copyright or copyrights for the package.

- \* "You" is you, if you're thinking about copying or distributing this Package.

- \* "Reasonable copying fee" is whatever you can justify on the basis of media cost, duplication charges, time of people involved, and so on. (You will not be required to justify it to the Copyright Holder, but only to the computing community at large as a market that must bear the fee.)

- \* "Freely Available" means that no fee is charged for the item itself, though there may be fees involved in handling the item. It also means that recipients of the item may redistribute it under the same conditions they received it.

1. You may make and give away verbatim copies of the source form of the Standard Version of this Package without restriction, provided that you duplicate all of the original copyright notices and associated disclaimers.

2. You may apply bug fixes, portability fixes and other modifications derived from the Public Domain or from the Copyright Holder. A Package modified in such a way shall still be considered the Standard Version.

3. You may otherwise modify your copy of this Package in any way, provided that you insert a prominent notice in each changed file stating how and when you changed that file, and provided that you do at least ONE of the following:

- a) place your modifications in the Public Domain or otherwise make them Freely Available, such as by posting said modifications to Usenet or an equivalent medium, or placing the modifications on a major archive site such as ftp.uu.net, or by allowing the Copyright Holder to include your modifications in the Standard Version of the Package.

b) use the modified Package only within your corporation or organization.

c) rename any non-standard executables so the names do not conflict with standard executables, which must also be provided, and provide a separate manual page for each non-standard executable that clearly documents how it differs from the Standard Version.

d) make other distribution arrangements with the Copyright Holder.

4. You may distribute the programs of this Package in object code or executable form, provided that you do at least ONE of the following:

a) distribute a Standard Version of the executables and library files, together with instructions (in the manual page or equivalent) on where to get the Standard Version.

b) accompany the distribution with the machine-readable source of the Package with your modifications.

c) accompany any non-standard executables with their corresponding Standard Version executables, giving the non-standard executables non-standard names, and clearly documenting the differences in manual pages (or equivalent), together with instructions on where to get the Standard Version.

d) make other distribution arrangements with the Copyright Holder.

5. You may charge a reasonable copying fee for any distribution of this Package. You may charge any fee you choose for support of this Package. You may not charge a fee for this Package itself. However, you may distribute this Package in aggregate with other (possibly commercial) programs as part of a larger (possibly commercial) software distribution provided that you do not advertise this Package as a product of your own.

6. The scripts and library files supplied as input to or produced as output from the programs of this Package do not automatically fall under the copyright of this Package, but belong to whomever generated them, and may be sold commercially, and may be aggregated with this Package.

7. C or perl subroutines supplied by you and linked into this Package shall not be considered part of this Package.

8. The name of the Copyright Holder may not be used to endorse or promote products derived from this software without specific prior written permission.

9. THIS PACKAGE IS PROVIDED "AS IS" AND WITHOUT ANY EXPRESS OR IMPLIED WARRANTIES, INCLUDING, WITHOUT LIMITATION, THE IMPLIED

WARRANTIES OF MERCHANTABILITY AND FITNESS FOR A PARTICULAR PURPOSE.

The End

Copyright (c) 1998, 1999, 2000 Thai Open Source Software Center Ltd  
and Clark Cooper  
Copyright (c) 2001, 2002 Expat maintainers.

Permission is hereby granted, free of charge, to any person obtaining a copy of this software and associated documentation files (the "Software"), to deal in the Software without restriction, including without limitation the rights to use, copy, modify, merge, publish, distribute, sublicense, and/or sell copies of the Software, and to permit persons to whom the Software is furnished to do so, subject to the following conditions:

The above copyright notice and this permission notice shall be included in all copies or substantial portions of the Software.

THE SOFTWARE IS PROVIDED "AS IS", WITHOUT WARRANTY OF ANY KIND, EXPRESS OR IMPLIED, INCLUDING BUT NOT LIMITED TO THE WARRANTIES OF MERCHANTABILITY, FITNESS FOR A PARTICULAR PURPOSE AND NONINFRINGEMENT. IN NO EVENT SHALL THE AUTHORS OR COPYRIGHT HOLDERS BE LIABLE FOR ANY CLAIM, DAMAGES OR OTHER LIABILITY, WHETHER IN AN ACTION OF CONTRACT, TORT OR OTHERWISE, ARISING FROM, OUT OF OR IN CONNECTION WITH THE SOFTWARE OR THE USE OR OTHER DEALINGS IN THE SOFTWARE.

**NORTON LICENSE AGREEMENT**  
**Norton Ghost**

**IMPORTANT:** PLEASE READ THE TERMS AND CONDITIONS OF THIS LICENSE AGREEMENT (“LICENSE AGREEMENT”) CAREFULLY BEFORE USING THE SOFTWARE (AS DEFINED BELOW). SYMANTEC CORPORATION, IF YOU ARE LOCATED IN THE AMERICAS; OR SYMANTEC ASIA PACIFIC PTE LTD, IF YOU ARE LOCATED IN THE ASIA PACIFIC RIM OR JAPAN; OR SYMANTEC LIMITED, IF YOU ARE LOCATED IN EUROPE, THE MIDDLE EAST OR AFRICA (“SYMANTEC”) IS WILLING TO LICENSE THE SOFTWARE TO YOU AS THE INDIVIDUAL, THE COMPANY, OR THE LEGAL ENTITY THAT WILL BE UTILIZING THE SOFTWARE (REFERENCED BELOW AS “YOU” OR “YOUR”) ONLY ON THE CONDITION THAT YOU ACCEPT ALL OF THE TERMS OF THIS LICENSE AGREEMENT. THIS IS A LEGAL AND ENFORCEABLE CONTRACT BETWEEN YOU AND SYMANTEC. BY OPENING THIS PACKAGE, BREAKING THE SEAL, CLICKING THE “I AGREE” OR “YES” BUTTON OR OTHERWISE INDICATING ASSENT ELECTRONICALLY, OR LOADING THE SOFTWARE, YOU AGREE TO THE TERMS AND CONDITIONS OF THIS LICENSE AGREEMENT. IF YOU DO NOT AGREE TO THESE TERMS AND CONDITIONS, CLICK THE “CANCEL” OR “NO” BUTTON OR OTHERWISE INDICATE REFUSAL, MAKE NO FURTHER USE OF THE SOFTWARE, AND CONTACT YOUR VENDOR OR SYMANTEC CUSTOMER SERVICE, USING THE CONTACT DETAILS IN SECTION 10 OF THIS LICENSE AGREEMENT, FOR INFORMATION ON HOW TO OBTAIN A REFUND OF THE MONEY YOU PAID FOR THE SOFTWARE (LESS SHIPPING, HANDLING, AND ANY APPLICABLE TAXES EXCEPT IN CERTAIN STATES AND COUNTRIES WHERE SHIPPING, HANDLING, AND TAXES ARE REFUNDABLE) AT ANY TIME DURING THE SIXTY (60) DAY PERIOD FOLLOWING THE DATE OF PURCHASE.

1. License:

The software (including any accompanying features and services) and documentation (including any product packaging) (the “Documentation”), that accompanies this License Agreement (collectively the “Software”) is the property of Symantec or its licensors, and is protected by copyright law. Although Symantec continues to own the Software, You will have certain rights to use the Software after Your acceptance of this License Agreement. This License Agreement governs any releases, revisions, or enhancements to the Software, that Symantec may furnish to You. Subject to Symantec’s right to terminate for Your breach pursuant to Section 9, Your rights and obligations under this License Agreement with respect to the use of this Software (excluding the Content Updates described in Section 2) shall be perpetual and shall be as follows.

You may:

- A. use one copy of the Software on a single computer. If a greater number of copies and/or number of computers is specified within the Documentation or the applicable transaction documentation from the authorized distributor or reseller from which You obtained the Software, You may use the Software in accordance with such specifications;
- B. make one copy of the Software for back-up or archival purposes, or copy the Software onto the hard disk of Your computer and retain the original for back-up or archival purposes;
- C. use the Software on a network, provided that You have a licensed copy of the Software for each computer that can access the Software over that network;
- D. permanently transfer all of Your rights in the Software granted under this License Agreement to another person or entity, provided that You retain no copies of the Software and the transferee agrees to the terms of this License Agreement. Partial transfer of Your rights under this License Agreement shall not be permitted. For example, if the applicable documentation grants You the right to use multiple copies of the Software, only a transfer of the rights to use all such copies of the Software would be valid; and
- E. use the Software in accordance with any additional permitted uses which may be set forth below.

You may not, nor may you permit any other person to:

- A. sublicense, rent or lease any portion of the Software;
- B. reverse engineer, decompile, disassemble, modify, translate, make any attempt to discover the source code of the Software or create derivative works from the Software;
- C. use the Software as part of a facility management, timesharing, service provider or service bureau arrangement; or
- D. use the Software in any manner that is not permitted pursuant to this License Agreement.



## 2. Content Updates:

Certain Software uses content that is updated from time to time, including but not limited to the following Software: antivirus and crimeware software use updated virus definitions; antispymware software uses updated spyware definitions; antispam software uses updated antispam rules; content filtering and antiphishing software use updated URL lists; some firewall software use updated firewall rules; vulnerability assessment products use updated vulnerability data and web site authentication software uses updated lists of authenticated web pages; these updates are collectively referred to as "Content Updates" (or alternatively referred to as "Protection Updates" or "Security Updates" at times). You shall have the right to obtain Content Updates for any period for which You have purchased a subscription for Content Updates for the Software (including any subscription included with Your original purchase of the Software), except for those Content Updates that Symantec elects to make available by separate paid subscription, or for any period for which You have otherwise separately acquired the right to obtain Content Updates. Symantec reserves the right to designate specified Content Updates as requiring purchase of a separate subscription at any time and without notice to You; provided, however, that if You purchase a subscription that includes particular Content Updates on the date of purchase, You will not have to pay an additional fee to continue receiving such Content Updates for the remaining period of Your existing subscription even if Symantec designates such Content Updates as requiring separate purchase. This License Agreement does not otherwise permit You to obtain and use Content Updates.

## 3. Product Installation; Required Activation:

A. During the installation process, the Software may uninstall or disable other security products, or features thereof, if such products or features are incompatible with the Software or for purposes of improving the overall functionality of the Software.

B. There may be technological measures in this Software that are designed to prevent unlicensed or illegal use of the Software. You agree that Symantec may use these measures to protect Symantec against software piracy. This Software may contain enforcement technology that limits the ability to install and uninstall the Software on a computer to not more than a finite number of times for a finite number of computers. This License Agreement and the Software containing enforcement technology may require activation as further set forth in the Documentation. If so, the Software will only operate for a finite period of time prior to Software activation by You. During activation, You may be required to provide Your unique product key accompanying the Software and computer configuration in the form of an alphanumeric code over the Internet to verify the authenticity of the Software. If You do not complete the activation within the finite period of time set forth in the Documentation, or as prompted by the Software, the Software will cease to function until activation is complete; at which time the Software functionality will be restored. In the event that You are not able to activate the Software over the Internet, or through any other method specified during the activation process, You may contact Symantec Customer Support using the information provided by Symantec during activation, or as set forth below.

## 4. Privacy; Data Protection:

From time to time, the Software may collect certain information from the computer on which it is installed, which may include:

- Information on potential security risks as well as URLs of websites visited that the Software deems potentially fraudulent. The URLs could contain personally identifiable information that a potentially fraudulent website is attempting to obtain without Your permission. This information is collected by Symantec for the purpose of evaluating and improving the ability of Symantec's products to detect malicious behavior, potentially fraudulent websites and other Internet security risks. This information will not be correlated with any personally identifiable information.
- Portable executable files that are identified as potential malware, including information on the actions taken by such files at the time of installation. These files are submitted to Symantec using the Software's automatic submission function. The collected files could contain personally identifiable information that has been obtained by the malware without Your permission. Files of this type are being collected by Symantec only for the purpose of improving the ability of Symantec's products to detect malicious behavior. Symantec will not correlate these files with any personally identifiable information. Such automatic submission function may be deactivated after installation by following the instructions in the Documentation for applicable products.

- The name given during initial setup to the computer on which the Software is being installed. If collected, the name will be used by Symantec as an account name for such computer under which You may elect to receive additional services and/or under which You may use certain features of the Software. You may change the account name at any time after installation of the Software (recommended).
- Status information regarding installation and operation of the Software. This information indicates to Symantec whether installation of the Software was successfully completed as well as whether the Software has encountered an error. The status information could contain personally identifiable information only if such information is included in the name of the file or folder encountered by the Software at the time of installation or error. The status information is collected by Symantec for the purpose of evaluating and improving Symantec's product performance and installation success rate. This information will not be correlated with any personally identifiable information.
- Information contained in email messages that you send through the Software to Symantec to report as spam or as incorrectly identified as spam. These email messages may contain personally identifiable information and will be sent to Symantec only with your permission, and will not be sent automatically. If you send such messages to Symantec, Symantec will use them only for the purpose of improving the detection ability of Symantec's antispam technology. Symantec will not correlate these files with any other personally identifiable information.
- The IP address of the computer on which the Software is installed, as well as other general, statistical information used for license administration, product analysis, and for improving product functionality. This information will not be correlated with any personally identifiable information.

The collected information as set out above is necessary for the purpose of optimizing the functionality of Symantec's products and may be transferred to the Symantec group in the United States or other countries that may have less protective data protection laws than the region in which You are situated (including the European Union), but Symantec has taken steps so that the collected information, if transferred, receives an adequate level of protection.

Symantec may disclose the collected information if asked to do so by a law enforcement official as required or permitted by law or in response to a subpoena or other legal process. In order to promote awareness, detection and prevention of Internet security risks, Symantec may share certain information with research organizations and other security software vendors. Symantec may also use statistics derived from the information to track and publish reports on security risk trends. By using the Software, You acknowledge and agree that Symantec may collect, transmit, store, disclose and analyze such information for these purposes.

#### 5. Sixty (60) Day Money Back Guarantee:

If You are the original licensee of this copy of the Software and are not completely satisfied with it for any reason, please make no further use of the Software and contact Symantec Customer Service, using the contact details set out in Section 10 of this License Agreement, for a refund of the money You paid for the Software (less shipping, handling, and any applicable taxes except in certain states and countries where shipping, handling and taxes are refundable) at any time during the sixty (60) day period following the date of purchase.

#### 6. Limited Warranty:

Symantec warrants that any media manufactured by Symantec on which the Software is distributed will be free from defects for a period of sixty (60) days from the date of delivery of the Software to You. Your sole remedy in the event of a breach of this warranty will be that Symantec will, at its option, replace any defective media returned to Symantec within the warranty period or refund the money You paid for the Software. Symantec does not warrant that the Software will meet Your requirements or that operation of the Software will be uninterrupted or that the Software will be error-free.

**TO THE MAXIMUM EXTENT PERMITTED BY APPLICABLE LAW, THE ABOVE WARRANTY IS EXCLUSIVE AND IN LIEU OF ALL OTHER WARRANTIES, WHETHER EXPRESS OR IMPLIED, INCLUDING THE IMPLIED WARRANTIES OF MERCHANTABILITY, FITNESS FOR A PARTICULAR PURPOSE, AND NON-INFRINGEMENT OF INTELLECTUAL PROPERTY RIGHTS. THIS WARRANTY GIVES YOU SPECIFIC LEGAL RIGHTS. YOU MAY HAVE OTHER RIGHTS, WHICH VARY FROM STATE TO STATE AND COUNTRY TO COUNTRY.**

7. Disclaimer of Damages:

**SOME STATES AND COUNTRIES DO NOT ALLOW THE LIMITATION OR EXCLUSION OF LIABILITY FOR INCIDENTAL OR CONSEQUENTIAL DAMAGES, SO THE BELOW LIMITATION OR EXCLUSION MAY NOT APPLY TO YOU.**

**TO THE MAXIMUM EXTENT PERMITTED BY APPLICABLE LAW AND REGARDLESS OF WHETHER ANY REMEDY SET FORTH HEREIN FAILS OF ITS ESSENTIAL PURPOSE, IN NO EVENT WILL SYMANTEC OR ITS LICENSORS BE LIABLE TO YOU FOR ANY SPECIAL, CONSEQUENTIAL, INDIRECT, OR SIMILAR DAMAGES, INCLUDING ANY LOST PROFITS OR LOST DATA ARISING OUT OF THE USE OR INABILITY TO USE THE SOFTWARE EVEN IF SYMANTEC HAS BEEN ADVISED OF THE POSSIBILITY OF SUCH DAMAGES.**

**IN NO CASE SHALL SYMANTEC'S OR ITS LICENSORS' LIABILITY EXCEED THE PURCHASE PRICE WHICH YOU PAID FOR THE SOFTWARE. The disclaimers and limitations set forth above will apply regardless of whether You accept the Software.**

8. U.S. Government Restricted Rights:

The Software is deemed to be commercial computer software as defined in FAR 12.212 and subject to restricted rights as defined in FAR Section 52.227-19 "Commercial Computer Software - Restricted Rights" and DFARS 227.7202, "Rights in Commercial Computer Software or Commercial Computer Software Documentation", as applicable, and any successor regulations. Any use, modification, reproduction release, performance, display or disclosure of the Software by the U.S. Government shall be solely in accordance with the terms of this License Agreement.

9. Export Regulation:

You acknowledge that the Software and related technical data and services (collectively "Controlled Technology") may be subject to the import and export laws of the United States, specifically the U.S. Export Administration Regulations (EAR), and the laws of any country where Controlled Technology is imported or re-exported. You agree to comply with all relevant laws and will not export any Controlled Technology in contravention to U.S. law nor to any prohibited country, entity, or person for which an export license or other governmental approval is required. All Symantec product is prohibited for export or re-export to Cuba, North Korea, Iran, Syria and Sudan and to any country subject to relevant trade sanctions. **USE OR FACILITATION OF SYMANTEC PRODUCT IN CONNECTION WITH ANY ACTIVITY INCLUDING, BUT NOT LIMITED TO, THE DESIGN, DEVELOPMENT, FABRICATION, TRAINING, OR TESTING OF CHEMICAL, BIOLOGICAL, OR NUCLEAR MATERIALS, OR MISSILES, DRONES, OR SPACE LAUNCH VEHICLES CAPABLE OF DELIVERING WEAPONS OF MASS DESTRUCTION IS PROHIBITED, IN ACCORDANCE WITH U.S. LAW.**

10. General:

This License Agreement will be governed by the laws of the State of California, United States of America. This License Agreement is the entire agreement between You and Symantec relating to the Software and: (i) supersedes all prior or contemporaneous oral or written communications, proposals, and representations with respect to its subject matter; and (ii) prevails over any conflicting or additional terms of any quote, order, acknowledgment, or similar communications between the parties. Notwithstanding the foregoing, nothing in this License Agreement will diminish any rights You may have under existing consumer protection legislation or other applicable laws in Your jurisdiction that may not be waived by contract. This License Agreement shall terminate upon Your breach of any term contained in this License Agreement and You shall cease use of and destroy all copies of the Software and Documentation. The disclaimers of warranties and damages and limitations on liability shall survive termination. This License Agreement may only be modified by the Documentation or by a written document that has been signed by both You and Symantec. Should You have any questions concerning this License Agreement, or if You desire to contact Symantec for any reason, please write to Symantec Customer Service, 555 International Way, Springfield, OR 97477, U.S.A., or visit the Support page at [www.symantec.com](http://www.symantec.com).

CPS / P 3.0 / USE

Additional Terms and Conditions:

In addition to the terms and conditions set forth above, the following terms and conditions will also apply to Your use of the Software:

- A. You may use the Software on one Device to clone, or apply an image of a hard drive on that Device, or to another hard drive on the same Device, a replacement Device, secondary media, or network drive.
- B. You may use the Software on a Device to create an image file of a hard drive on that Device and store the image file on fixed or removable media for disaster recovery purposes.
- C. You may use the Software as a boot disk to re-apply the hard drive image that was created for disaster recovery purposes to the hard drive on the Device from which the disaster recovery image was made or on a replacement Device provided that the software has been removed from the original Device.
- D. You may use the Software to clone a hard drive from a Device to a replacement Device, in the manner described in the Software documentation and to use the Software on the replacement Device provided that the Software has been removed from the original Device.
- E. You may not use the Software commercially or non-commercially for the purpose of creating an image on multiple Devices or hard drives, except for multiple hard drives installed in or attached directly to the original Device.
- F. For the purposes of this License Agreement, a virtual device is considered the same as a physical device.
- G. If the Software You have licensed includes the Symantec Recovery Disk ("Component") the following uses and restrictions apply to the Software:
  - (i) The Component contains Windows® software licensed from Microsoft Corporation. Microsoft Corporation has no liability to You for the Component. Any support for the Component will be provided by Symantec in accordance with Symantec's then-current support guidelines.
  - (ii) THE COMPONENT CONTAINS A TIME-OUT FEATURE THAT WILL AUTOMATICALLY RE-BOOT THE DEVICE AFTER SEVENTY-TWO HOURS OF CONTINUOUS USE. THIS TIME-OUT FEATURE WILL RESET EACH TIME THE COMPONENT IS RE-LAUNCHED.
  - (iii) The Component may be used as a boot, diagnostic, disaster recovery, setup, restoration, emergency service, installation, test, and configuration utility program. Use of the Component as a general purpose operating system or as a substitute for a fully functional version of any operating system product is strictly prohibited.

Windows® is a registered trademark of Microsoft Corporation.

H. The Software may include access to the Google Desktop™ search engine ("Application"). Your use of the Application is governed by an agreement between you and Google. Symantec has no liability to You for your use of Application and does not warranty or provide technical support for Your use of the Application.

Google™ and Google Desktop™ are trademarks of Google Inc.

I. The Software may contain third party device drivers. Such device drivers are provided solely for Your convenience. It is Your responsibility to confirm whether such device drivers are applicable to Your environment. The device drivers are provided by Symantec "AS IS" WITHOUT ANY TECHNICAL SUPPORT OR WARRANTY OF ANY KIND, INCLUDING BUT NOT LIMITED TO FITNESS FOR A PARTICULAR PURPOSE. TO THE MAXIMUM EXTENT PERMITTED BY APPLICABLE LAW, IN NO EVENT AND UNDER NO LEGAL THEORY SHALL SYMANTEC OR ITS SUPPLIERS BE LIABLE TO YOU FOR ANY DIRECT, CONSEQUENTIAL, SPECIAL, INCIDENTAL, PUNITIVE OR INDIRECT DAMAGES OF ANY KIND ARISING OUT OF OR RELATED TO THE THIRD PARTY DEVICE DRIVER.

CPS / NGH 15.0 Add Terms / EN GLBL