

# G2

Linear Accent

---

## INSTALLATION GUIDE

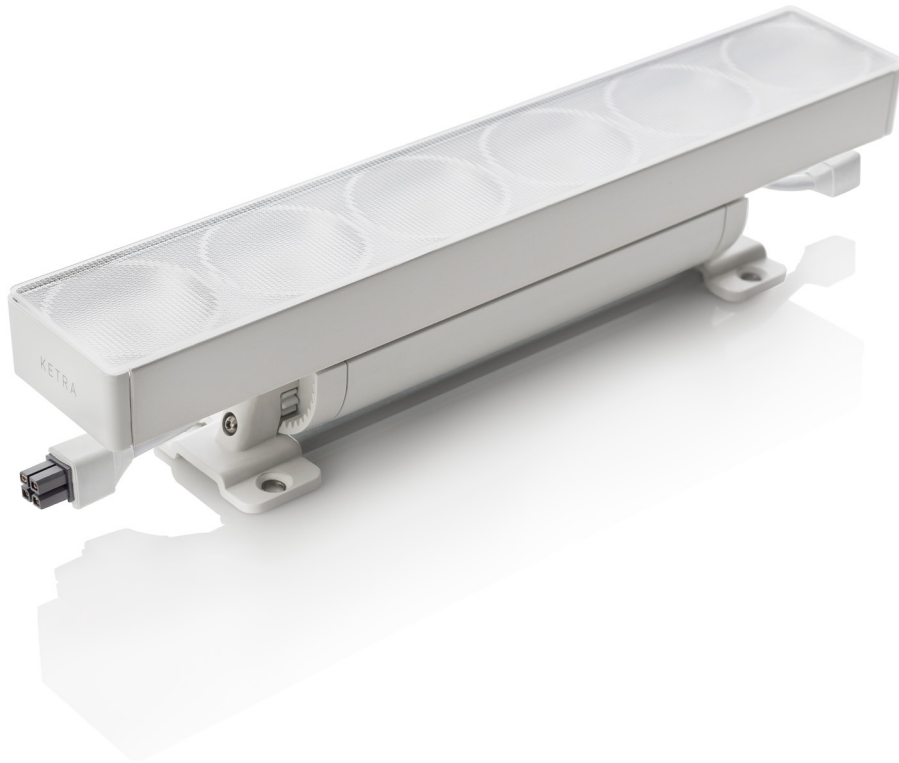

### Supported Models:

G21210BTGR33AWH/BK  
G21210BTNFL33AWH/BK  
G21210BTFL33AWH/BK  
G21210BTWFL33AWH/BK

G21207BTGR33AWH/BK  
G21207BTNFL33AWH/BK  
G21207BTFL33AWH/BK  
G21207BTWFL33AWH/BK

G21204BTGR33AWH/BK  
G21204BTNFL33AWH/BK  
G21204BTFL33AWH/BK  
G21204BTWFL33AWH/BK



## WARNING



---

### Risk of electric shock. May result in serious injury or death.

Turn power OFF at circuit breaker or remove fuse. Damage to this product caused by wiring with power on voids the warranty.

Due to risk of electric shock, a licensed electrician should install this power supply unit in strict compliance with the National Electric Code and any state or local code which may apply.

This device complies with Part 15 of the FCC Rules. Operation is subject to the following two conditions: (1) this device may not cause harmful interference, and (2) this device must accept any interference received, including interference that may cause undesired operation.



Note: This equipment has been tested and found to comply with the limits for a Class B digital device, pursuant to part 15 of the FCC Rules. These limits are designed to provide reasonable protection against harmful interference in a residential installation. This equipment generates, uses and can radiate radio frequency energy and, if not installed and used in accordance with the instructions, may cause harmful interference to radio communications. However, there is no guarantee that interference will not occur in a particular installation. If this equipment does cause harmful interference to radio or television reception, which can be determined by turning the equipment off and on, the user is encouraged to try to correct the interference by one or more of the following measures:

- Reorient or relocate the receiving antenna.
- Increase the separation between the equipment and receiver.
- Connect the equipment into an outlet on a circuit different from that to which the receiver is connected.
- Consult the dealer or an experienced radio/TV technician for help.

# CONTENTS

---

Product Overview . . . . . 4

Included Components/ Specs . . . . . 5

Pre-Installation . . . . . 6

Installation . . . . . 10

Troubleshooting . . . . . 13

Warranty/ Tech Support . . . . . 14

# PRODUCT OVERVIEW

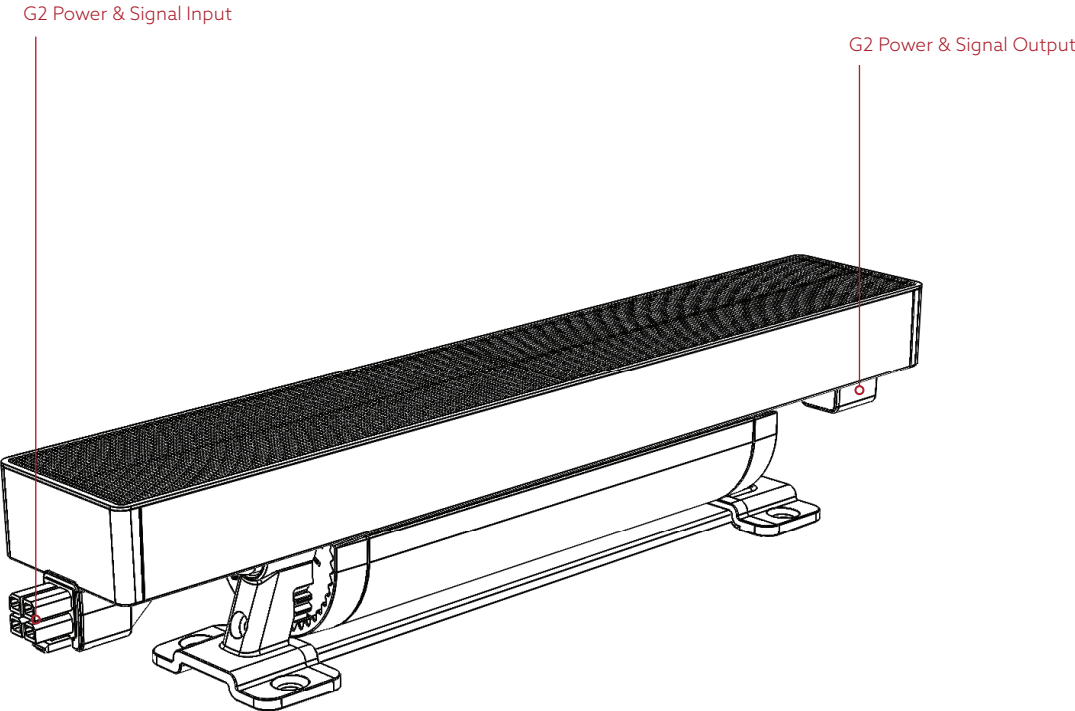

# INCLUDED COMPONENTS/ SPECS

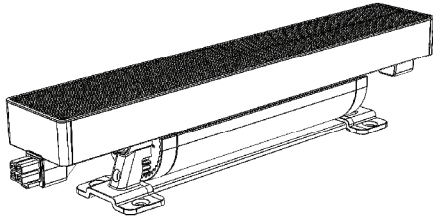

G2 LINEAR UNIT

G2 SYSTEM COMPONENTS INCLUDE:

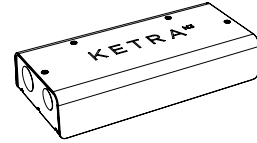

N3 SATELLITE

G2 LEADER CABLE

TERMINATOR

G2 JUMPER CABLES  
AS NEEDED

## SPECIFICATIONS

### ENVIRONMENTAL

Operating Temperature	-20° to 40°C
Storage Temperature	-20° to 80°C
Humidity	0 - 95%, Non-condensing
Certification	UL, cUL, FCC Class B, RoHS
Location	UL Damp Location, IP20

### POWER

Voltage	120VAC, 60Hz
	277VAC, 60Hz
Power Consumption	G2.10 15.5W/ft (304.8mm)
	G2.07 11W/ft (304.8mm)
	G2.04 7.7W/ft (304.8mm)
Current at 220V	G2.10 0.07 A
	G2.07 0.05 A
	G2.04 0.04 A
Max. Qty of Fixtures Per N3	40
Max Total Run Length, including cable, Per N3	100 ft

### OPTICAL

Lumen Output	G2.10 1000lm/ft,
	G2.07 700lm/ft,
	G2.04 400lm/ft
CRI	>90
Lumen Maintenance	50K Hours to L70@25°C Ambient
Beam Angles	10x60°, 30x45°, 60x60°, 120x120°
Dimming Range	0.1-100% lm output

### MECHANICAL

Weight	1.35 lbs, 600 g
Housing Material	Powder Coated Aluminum, Polymer
Lens Material	Non-yellowing heat/ UV stabilized PMMA

# PRE-INSTALLATION



## WARNING



**Warning:** Turn OFF electrical power to all circuit breakers feeding into the panel before installing or servicing this product.

**Warning:** Improper use or installation can cause **SERIOUS INJURY, DEATH, OR LOSS/DAMAGE OF PROPERTY.**

- This device must be installed by a licensed electrician in accordance with all national and local codes.
- Read all installation instructions and warnings before beginning install process.
- Installation instructions may change without notice due to continuous improvements.
- Do not use product if it is damaged.
- Fixtures contain no user serviceable parts.
- Do not connect product to any voltage or frequency supply other than that for which it is rated.
- Rated for direct insulation contact.
- If placed in enclosure alongside other electrical components, take necessary precautions regarding operating temperatures.
- Product is UL surface mount listed. Does not require dedicated enclosure.

# PRE-INSTALLATION

## Note:

- Each run of product must be connected to a Ketra N3 Satellite.
- The N3 Satellite is installed in line between the AC Mains power source and the run of G2 Linear. It couples together power and data, enabling a simple installation using a single class 1 cable run. The leader cable is 50 ft long and may be cut to length. The products do not require a separate low-voltage data cable.
- Please refer to the installation instructions for the N3 Satellite for more details.
- Each N3 Satellite can support up to 40 ft of product. For longer run lengths, use additional N3 Satellites for each 40 ft (or less) of product.
- N3 Satellites can be connected to the same power source and do not each require a dedicated circuit.
- Connect all product in a single run from the N3 Satellite.
- 'Home Run' style installations are not supported.

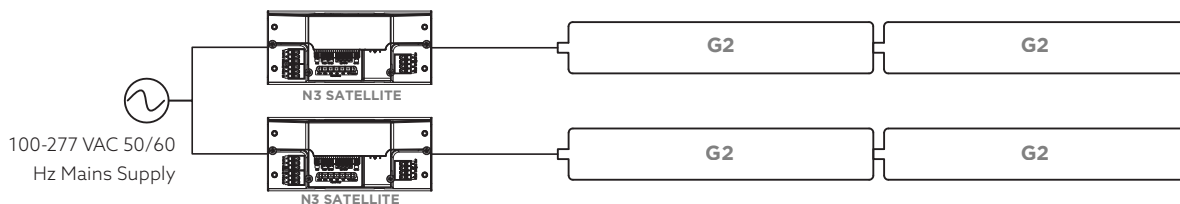
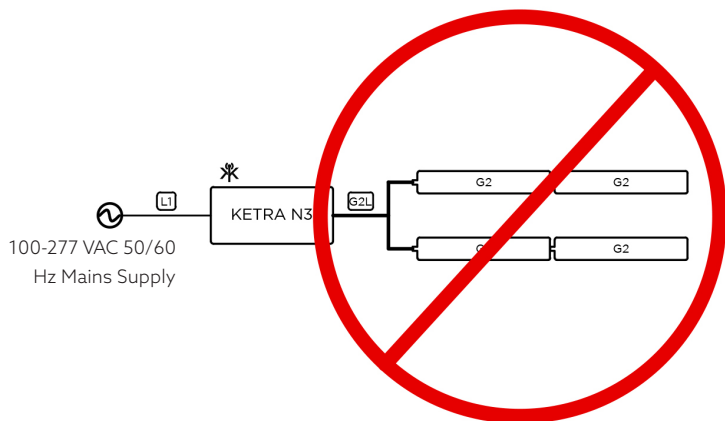

Figure 1



HOME RUN TOPOLOGIES ARE NOT SUPPORTED

Figure 2

## PRE-INSTALLATION

### Note:

- Products are connected end-to-end via the integrated connectors at each end of product. Note that there is an "input" and "output" connector on each product and orientation is critical. A common mistake made is to install the products backwards. Jumper cables may be inserted in between fixtures in order to make installation easier.

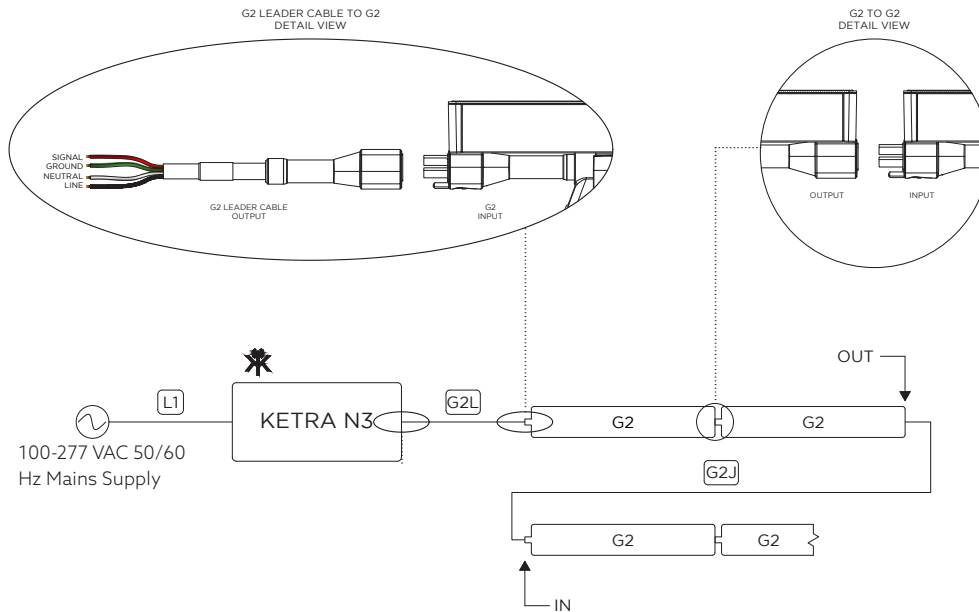

Figure 3

- 50 ft leader cable max
- 40 ft of G2 Linear fixtures
- 100 ft total run max, including leader cable, fixtures, and jumper cables

A typical installation includes:

- N3 Satellite
- Leader cable with terminator
- 1 to 40 G2 Linear fixtures
- Optional jumper cables as needed
- The G2 has mounting feet that have one thru hole on each side.
- Attach the product to a flat surface using appropriate #8, #9, or #10 countersunk fasteners (e.g. wood screws, sheet metal screws .)



## PRE-INSTALLATION

Record location and serial number of each N3 Satellite:

- The serial number is helpful when configuring the products after installation.
- We recommend noting the serial number, location, and fixtures connected on installation drawings. This can help with future programming and configuration. (The serial number can be found on the top of the control board cover - see fig. 4.)

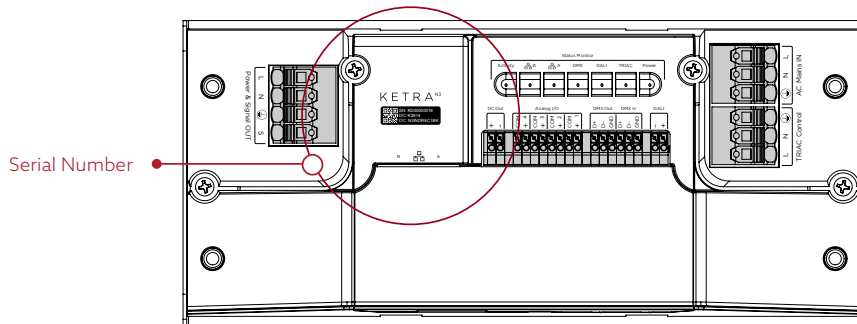

Figure 4

- The product can be rotated 180 degrees to enable aiming the beam. Note that when rotated, the overall height and width of the space required for installation may change. (see fig. 5)

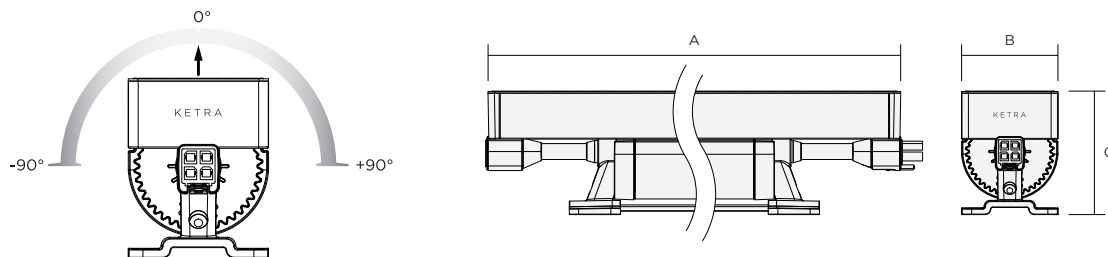

Figure 5

# INSTALLATION

**Warning:** Before physical mounting, turn OFF electrical power to all circuit breakers feeding into the panel before installing or servicing this product.

## INSTALLATION

---

### STEP 1

#### Connect Fixtures

1. Place products in intended installation position.
2. Connect fixtures end to end.
3. Use jumper cables where appropriate.
4. Ensure that connectors are completely engaged.
5. Do not install in a way that puts any pulling force on the cables and connectors.
6. Affix units to a flat surface using appropriate fasteners (e.g. wood screws, sheet metal screws).

### STEP 2

#### Attach Terminator

1. A terminator plug is included with each leader cable.
2. Insert the terminator into the output connector of the last fixture in the run.

### STEP 3

#### Connect Leader Cable

1. One end of the leader cable has a connector and the other end has flying leads.
  - The connector end of the leader cable connects to the first product in the run.
  - The flying leads end of the leader cable connects to the output side of the N3 Satellite. Note that the leader cable can be cut to length.
2. Make the connections to the N3 Satellite.
  - Use Ketra supplied G2 leader cable or if required, conduit or NM type cable as appropriate. (Note: Acceptable wire is both solid core and stranded. Gauge range is 12-18 AWG.)
  - Open appropriate terminals by flipping orange levers into UP position. (see fig. 6)

# INSTALLATION

- Make connections to the "Power and Signal Out" section; connecting to appropriate line, neutral, and ground terminals. (Note: wire strip length is 12mm/.47inches.) Insert appropriate conductors from Mains Power. (see fig. 7)

Black conductor goes to "L" terminal.  
White conductor goes to "N" terminal.  
Green conductor goes to "⊕" terminal.  
Red conductor goes to "S" terminal.

**Note:** Conductor colors are not always as listed. These colors vary depending on your wiring setup. To ensure the correct wiring, consult a professional electrician.

For additional information, refer to the N3 Satellite product installation guide.

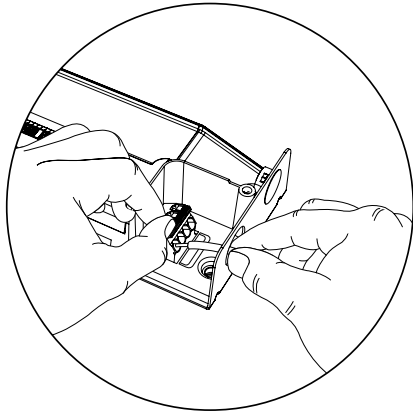

Figure 6

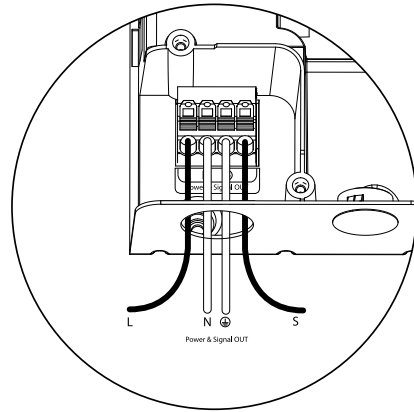

Figure 7

## STEP 4 Apply Power at Source

1. Refer to the N3 Satellite product installation guide for instructions to apply power to N3 Satellite.

## STEP 5 Verify Successful Installation

1. Apply power to circuit.
  - If data is present at G2 Linear control port, appropriate LED will indicate status.
  - Green "Power" LED on N3 Satellite will illuminate indicating successful installation and product functionality.
  - If data is present at G2 Linear control port, appropriate LED will indicate status.
2. Disconnect power and install cover of N3 Satellite.
3. Restore power and configure device using Ketra Design Studio Software.
4. For software download and updates, visit [ketra.com](http://ketra.com).

# INSTALLATION

## STEP 6

### Aim Fixtures

1. Rotate the fixture to aim the product.
2. The product includes a geared constant-torque hinge that does not require any locking mechanism.
3. **Optional** Tighten the locking screws at the end of each fixture using a T10 torx wrench or 2mm Hex wrench.

## STEP 7

### Address Fixtures and Program Content

1. Use Ketra's Design Studio Software to address and configure the products.

# TROUBLESHOOTING

Prior to commissioning in Design Studio, Ketra's G2 Linear should power on to a default white state. If it powers on to some other color, that means there's a problem in the installation conditions. See the table below for each color's meaning.

**Trouble-Shooting Table**

Color	Condition	Correction
Red	Low input voltage on the power line	Ensure that the input voltage is 120V or 277V, + or - 10%
Magenta	Signaling wire connection not detected	Cut power and reconnect the red conductor of the leader cable to the N3's "S" port
Red-Green-Blue Pattern	Line and neutral wiring switched	Cut power, and reverse line and neutral wiring
Red-Green Pattern*	Line and neutral wiring switched	Cut power, and reverse line and neutral wiring
Yellow	Multiple runs of linear product detected	Cut power and disconnect all but one run of G2. Only one run can be connected to a satellite
Turquoise	More than 40ft of linear product detected	Remove the turquoise linears and reboot the satellite
Green	More than 100ft total run length detected (including cables & fixtures)	Remove excess cabling and/or fixtures, and reboot the satellite
Dark Blue		

\* For product ordered in 2019

# WARRANTY/ TECH SUPPORT

Limited warranty terms can be found at:

**[ketra.com/warranty](http://ketra.com/warranty)**

For questions and technical support, please contact:

**(844) 588-6445**

**[ketrasupport@lutron.com](mailto:ketrasupport@lutron.com)**



