



Source Four[®] LED

User Manual

Version 1.8.0

Part Number: 7460M1200-1.8.0 Rev: J

Released: 2018-05

ETC® and Source Four® are registered trademarks of Electronic Theatre Controls, Inc. in the United States and other countries.

All other trademarks, both marked and not marked, are the property of their respective owners.

ETC intends this document, whether printed or electronic, to be provided in its entirety. This product is intended for professional use only. Read this entire document before using this product.

This product is protected by one or more of the following US patents: 6,016,038, 6,150,774, 6,683,423, 6,788,011, 6,806,659, 7,023,543, 7,901,089, 8,384,294, 8,403,523, 8,593,074, 8,633,649, 8,723,450, 8,878,455, 9,041,308, and 9,140,425.

This product is protected by one or more of the following EU patents: 2150746, 2638781, and 602011015730.

Other US and international patents pending.

Table of Contents

	Introduction	1
	Quick Setups	1
	Lustr+ and Series 2 Lustr.	1
	Studio HD, Series 2 Daylight HD, and Series 2 Tungsten HD	1
	Daylight and Tungsten	2
	Models	2
	Fixture Components	3
	Applications	4
	Document Conventions	4
	Notices	4
	Typography Used in This Guide	4
	Safety	5
	Contacts	6
Chapter 1	Quick Start	7
	Install	7
	Connect	7
	Focus	7
	Set DMX Address	8
	Install Soft Focus Diffuser	8
	Use Quick Color (Excluding Daylight and Tungsten)	8
	Use Quick Setups	8
	Quick Setups	9
Chapter 2	Installation and User Interface	11
	Specifications	11
	Typical Power Consumption	12
	Note About LED Fixtures	13
	Color Rendering Index and Color Quality Scale Ratings	13

Installation	14
Basic Assembly	14
Mounting Hardware	14
Install Lens Tube	15
Aim Adjustments	16
Focus the Beam	17
Shape the Beam	17
Install a Soft Focus Diffuser	18
Rotate the Shutter Barrel Assembly	19
Adjust the C-clamp (North America)	20
Adjust the Yoke Position	20
Installation Clearances	21
Cooling and Duty Cycle	21
Dimensions and Hanging Clearances	22
Safety Cable	23
Fixture Weight	23
Power and Data Cabling Requirements	24
Power	24
Data	24
Connections	25
Source Four LED Series Connections	25
Indicator Lights	25
DMX Addressing	26
DMX Profiles	26
Lustr+, Series 2 Lustr, Series 2 Daylight HD, Series 2 Tungsten HD, and Studio HD	26
Daylight and Tungsten	30
DMX Profile Tables	31
Channel Assignments in Direct Mode	33
Plus Seven Profile Options	33
DMX Footprints and Channel Mapping	33
Install Accessories	34
Color Frame Holder	34

Chapter 3

Basic Menu Navigation35

User Interface Overview	35
LCD	35
Keypad	35
Keypad Lockout	36
Status Indicators	37
Screen Navigation	37
Status (Home) Screens	38
Menu Navigation	39

Chapter 4	Operation	40
	Home Screen Displays	40
	All Fixtures (Excluding Daylight and Tungsten)	40
	Daylight and Tungsten Fixtures Only	40
	Main Menu	41
	DMX Start Address	41
	Quick Setups	42
	Advanced Settings	42
	Advanced Menu	43
	DMX Settings	43
	LED Settings	47
	Presets & Sequences	51
	Quick Color (excluding Daylight and Tungsten)	60
	Diagnostics	61
	Local Settings	65
	Copy All Settings	68
	Studio Settings	68
	All Fixtures Except Daylight and Tungsten	68
	Daylight and Tungsten only	71
	Error Messages	72
	Software Updates	72
	Routine Maintenance	72
	Cleaning the Field Lens	73
	Inspecting and Cleaning the Electronics	74
Appendix A	Menu Flow Chart	75
	Home and Main Menus (Excluding Daylight and Tungsten)	75
	Home and Main Menus (Daylight and Tungsten Only)	76
	Advanced Menu (Excluding Daylight and Tungsten)	77
	Advanced Menu (Daylight and Tungsten Only)	78
	Presets Menu (Excluding Daylight and Tungsten)	79
	Presets Menu (Daylight and Tungsten Only)	80
	Sequences Menu and Quick Color Menu	81
	Diagnostics Menu	82
	Diagnostics Test	83
	Diagnostics Recalibrate Fixture	84

Introduction

Congratulations on your purchase of a *Source Four LED Profile by ETC* product.

The Source Four LED Profile's x7 Color System™ seven-hue technology produces a light and color quality that conventional LED systems cannot duplicate. This unique color system produces bright, broad-spectrum whites and intense colors equally well, rendering pigments, objects, and skin tones in a natural way.

Daylight and Tungsten fixtures use high-output white LEDs for maximum brightness and efficacy. Tungsten interacts very well with incandescent sources, while Daylight easily replaces a variety of HMI lamps and natural sunlight.

Quick Setups

You can use any one of the Quick Setups and fine-tune settings for either console operation via DMX protocol or stand-alone operation. For advanced users, an expanded user interface provides easy navigation to all settings and options.

Lustr+ and Series 2 Lustr

Some of the options include:

- Multiple DMX profiles ranging from a simple 3-channel RGB profile to 8-channel direct color and intensity control
- Multiple dimming curve options
- Preset colors and sequences for stand-alone operation
- White point selection; white light and color behavior based on a specific color temperature white light such as 3200K or 5600K
- Loss-of-data behavior options
- Power regulation modes; three output options that offer a choice between maximum light output for lower duty cycles and maximum thermal stability and output consistency for higher duty cycles

Studio HD, Series 2 Daylight HD, and Series 2 Tungsten HD

Some of the options include:

- Balanced with x7 Color System for a spectrally rich, variable white light
- Color temperatures from 2000K–8375K
- Onboard +/- green adjustment
- Preset colors and sequences for stand-alone operation
- Multiple dimming curve options
- Power regulation modes; three output options that offer a choice between maximum light output for lower duty cycles and maximum thermal stability and output consistency for higher duty cycles

Daylight and Tungsten

Some of the options include:

- Multiple dimming curve options
- Presets and sequences for stand-alone operation
- Strobe
- Loss-of-data behavior options
- Power regulation modes; three output options that offer a choice between maximum light output for lower duty cycles and maximum thermal stability and output consistency for higher duty cycles

Models

Each member of the Source Four LED Profile product line is unique and optimized for a specific lighting task. All models are compatible with the complete line of Source Four lens tubes.

Lustr+

- Specialized 7-color x7 LED array
- Broad-spectrum color optimized for the best white and light tints across the entire white and pastel range
- Beautifully illuminates skin tones and other objects

Series 2 Lustr

- All the features of the Lustr+ with exceptional saturation and higher output

Studio HD

- A mix of high-output LEDs and carefully selected colors from the x7 spectrum
- Variable color temperature from 2700K to 6500K
- Deep spectrum whites with up to 94 CRI

Daylight

- 5600K nominal correlated color temperature
- 70 CRI typical

Series 2 Daylight HD

- Variable output cool white light recommended for use from 4000K to 6500K
- 91 CRI typical at 5600K

Tungsten

- 3000K nominal correlated color temperature
- 85 CRI typical

Series 2 Tungsten HD

- Variable output warm white light recommended for use from 2700K to 4500K
- 94 CRI typical at 3200K

Fixture Components

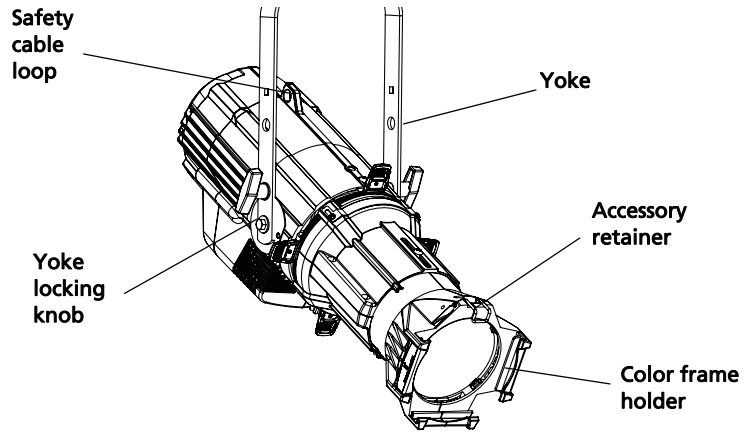

Figure-1.1 Components of the Source Four LED Profile fixture

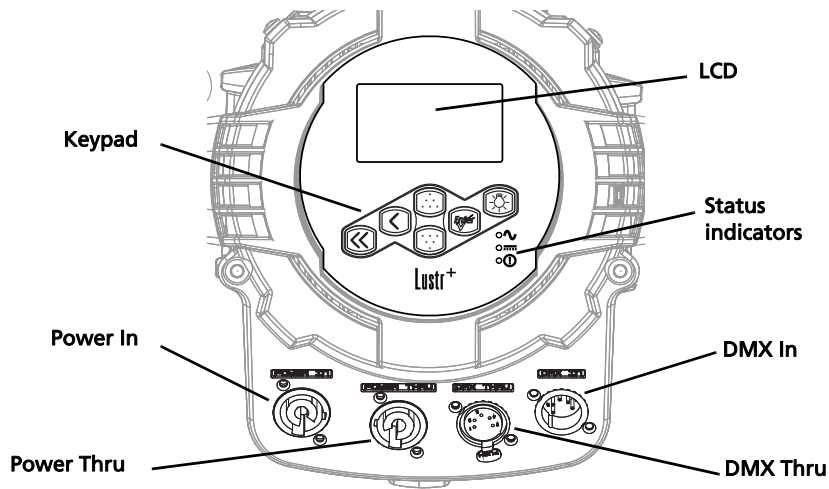

Figure-1.2 Components of the rear panel

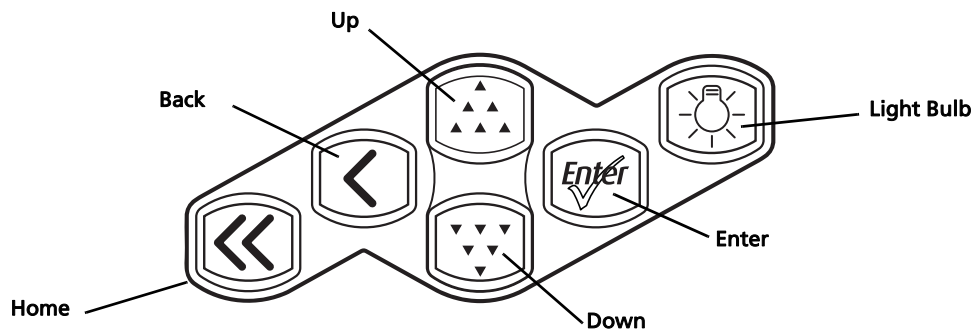

Figure-1.3 Keypad button functions

For information about the user interface, see [User Interface Overview](#) on [page 35](#).

Applications

- Theaters
- Studios
- Schools
- Houses of worship
- Hotels
- Convention centers
- Theme parks
- Museums
- Temporary events

Document Conventions

Notices

Throughout this manual, the following are used to alert you to notes and safety notices.



Note: *Notes are helpful hints and information that is supplemental to the main text.*



CAUTION: *A Caution statement indicates situations where there may be undefined or unwanted consequences of an action, potential for data loss or an equipment problem.*



WARNING: A Warning statement indicates situations where damage may occur, people may be harmed, or there are serious or dangerous consequences of an action.



WARNING: RISK OF ELECTRIC SHOCK! This warning statement indicates situations where there is a risk of electric shock.

Please email comments about this manual to: TechComm@etconnect.com.

Typography Used in This Guide

Menu items and commands you must perform are indicated in **bold text**. Keypad buttons are indicated in bold **[brackets]**. Menu selections or commands appear in **bold**. For example:

Press [**▼▼▼**] to select **Sequences** and then press [**Enter**].

Safety

The Source Four LED Profile fixtures are intended for professional use only. Read the entire User Manual before using equipment.



WARNING: Note the following safety warnings before use:

- Do not mount the Source Four LED Profile fixture on or near a flammable surface.
 - Do not use this fixture with a damaged power lead. If the power lead (cord set) is damaged, it must be replaced.
 - Do not use this fixture if glass lens is deeply scratched or cracked. Damaged lenses must be replaced.
 - Use the Source Four LED Profile fixture in dry locations only, where humidity does not exceed 90 percent (non-condensing). These fixtures are not intended for outdoor use.
 - Mount and support the fixture only by the primary suspension holes in the yoke or floor standing yoke.
 - Suspend the fixture from a suitable structure using only the hardware rated for the weight of the fixture.
 - In addition to primary suspension, attach a safety cable (ETC part number 7060A1022 or other approved safety cable or device) to the fixture housing. Appropriate attachment point (hole) is provided in the protruding tab on the fixture housing.
 - Disconnect the unit from power and DMX and allow the fixture to cool before removing or installing the shutter barrel or other adapters, and before all cleaning and maintenance.
-



- Note:**
- *Maximum recommended ambient operating temperature: $T_a=40^{\circ}\text{C}$ (104°F)*
 - *Maximum anticipated external surface temperature: $T_{max}=80^{\circ}\text{C}$ (176°F)*
 - *External temperature after 5 minutes of full-brightness operation at 25°C (77°F) ambient: 29.9°C (85.8°F)*
 - *External Temperature (steady state achieved) at 25°C (77°F): 41.5°C (106.7°F)*
-

Contacts

If you have questions about your Source Four LED Profile fixture that are not answered in this manual, please contact the supplier of your ETC equipment or ETC Technical Services. For general information, your most convenient resources are the references provided in this manual. To search more widely try the ETC web site at etcconnect.com.

For technical questions about Source Four LED Profile fixtures, contact ETC Technical Services directly at one of the offices listed below. Emergency service is available from all ETC offices outside of normal business hours.

Americas

ETC, Inc.
Technical Services Department
3031 Pleasant View Road
Middleton, WI 53562
800-775-4382 (USA, toll-free)
+1-608 831-4116
service@etcconnect.com

United Kingdom

ETC Ltd
Technical Services Department
26-28 Victoria Industrial Estate
Victoria Road,
London W3 6UU England
+44 (0)20 8896 1000
service@etceurope.com

Asia

ETC Asia
Technical Services Department
Room 1801, 18/F
Tower 1, Phase 1 Enterprise Square
9 Sheung Yuet Road
Kowloon Bay, Kowloon, Hong Kong
+852 2799 1220
service@etcasia.com

Germany

ETC GmbH
Technical Services Department
Ohmstrasse 3
83607 Holzkirchen, Germany
+49 (80 24) 47 00-0
techserv-hoki@etcconnect.com

Please e-mail comments about this manual to: TechComm@etcconnect.com.

Chapter 1

Quick Start

This section helps you to quickly use the Source Four LED fixture. For complete, detailed information and step-by-step instructions, see [Operation](#) on [page 40](#).

Install

- 1: Hang or mount the fixture using the provided hardware and approved hardware accessories.
- 2: Attach an approved safety cable when applicable.
- 3: Insert additional accessories (top hat, etc.) into the holder, if desired.

Connect

- 1: Attach the power cable to the Power In connector.
- 2: Attach 5-pin XLR cable to the DMX In connector (if using external control).
- 3: Plug the XLR cable (if using) into the DMX source or data daisy-chain.
- 4: Link additional fixtures via the Power Thru and DMX Thru connectors using the following guidelines.
 - Up to nine Lustr or seven Daylight HD/Tungsten HD luminaires (15A max) may be linked via Power Thru connector (10 Lustr or 8 Daylight HD/Tungsten HD fixtures total per circuit) when used with R20 Relay Module or Unison Echo® Relay Panel (consult breaker-trip curves when used with other equipment)
 - Up to 32 device loads on the DMX daisy-chain
- 5: Plug the power cable into AC power (100 to 240VAC, 50/60 Hz) on a non-dimmable circuit.









CAUTION: *The fixture must be connected to a non-dimmable power source in order to avoid damage to its internal power supply and other electrical components. Dimming will damage the fixture and void the warranty.*

Focus

- 1: With power supplied, wait for the fixture to boot up. This will take approximately ten seconds.
- 2: Press [] to open the **Presets & Sequences** menu.
- 3: Select **Focus** and then press []. This turns on the LED array to enable focusing.
- 4: Adjust the fixture's position as needed.
- 5: When focusing is complete, press [] to restore the fixture to its original preset.
- 6: Select [] to return to the home screen.

For information about the user interface, see [User Interface Overview](#) on [page 35](#).

Set DMX Address

- 1: From the main screen, press  to open the Main Menu.
- 2: On the **Main Menu**, scroll to **DMX Start Address** and then press .
- 3: Use  or  to scroll to the desired **address**.
- 4: Press  to select the **address** number.
- 5: Press  to return to the home screen.

A DMX address is not required if using stand-alone or master/slave control.

Install Soft Focus Diffuser

- 1: Install the Soft Focus diffuser into an A-Sized Pattern holder.
- 2: Insert the Pattern holder and diffuser into the Pattern holder slot, making sure the writing on the diffuser faces away from the Light engine.











For more information, see [Install a Soft Focus Diffuser](#) on [page 18](#).

Use Quick Color (Excluding Daylight and Tungsten)

Quick Color allows you to easily select a color and its intensity from a predefined menu. This feature overrides any presets or sequences previously selected and is only available when there is no external DMX signal to the fixture. For a list of available colors, see [Color Mixes](#) on [page 27](#).



Note: *Exiting the Quick Color menu will return the fixture to the state it was in prior to entering the menu.*

- 1: Scroll to **Quick Color** within the **Presets and Sequences** screen.
- 2: Press .
- 3: Scroll to **Color** and press .
- 4: Press  or  to select the desired color
- 5: Press  to commit the selection.
- 6: Scroll to **Intensity** and press .
- 7: Press and hold  or  to adjust the fixture's intensity.
- 8: Press  to commit the selection.
 - To set the Intensity to 0, press . Pressing  a second time will return the fixture to its previously set intensity.
 - If power to the fixture is lost while in Quick Color mode, the fixture will return to the Quick Color menu when power is restored.

Use Quick Setups

Various pre-programmed combinations of operational settings are available to quickly get you started. These settings are specifically created for different situations and are easily accessible on the fixture's user interface. Individual settings within each quick setup can be accessed via the Advanced menu in order to take advantage of all the possible control features.











Quick Setups

- 1: On the **Main Menu**, scroll to **Quick Setups**.
- 2: Press **[Enter]**.
- 3: Scroll to the desired setup and then press **[Enter]**.
An asterisk (*) next to the setup name indicates that setup is active.
- 4: Press **[Enter]** to return to the home screen.
The top line of the home screen displays the name of the active setup.



Quick Setup	Description	Profile	Features
General	<ul style="list-style-type: none"> • For general lighting • All-purpose settings for most lighting applications • The default setup for the Lustr+ and Series 2 Lustr 	Direct control	<ul style="list-style-type: none"> • Standard dimming curve • Regulated output for brightness consistency • Individual color channels plus master intensity control • Allows for native color space crossfades • Output is NOT color-calibrated
Stage	<ul style="list-style-type: none"> • For theatrical lighting • Tungsten-like performance and precise color-control • Uses the most DMX channels of all quick setups 	HSI Plus Seven enabled	<ul style="list-style-type: none"> • Incandescent dimming curve • Regulated output for brightness consistency • White point: 3200K
XT Arch	<ul style="list-style-type: none"> • Longevity and reliability in applications with limited access and extreme environments • High degree of output consistency and protection against temperature swings 	HSI	<ul style="list-style-type: none"> • Standard dimming curve • Protected output for high-heat environments • Reduced overall brightness • White point: 3200K
High Impact	<ul style="list-style-type: none"> • For concerts and high impact lighting • Enables quickest response, simple RGB control and strobe channel for maximum effect usage 	RGB	<ul style="list-style-type: none"> • Quick dimming response • Boosted output for maximum intensity • Reduced consistency of output • White point: 5600K
Studio	<ul style="list-style-type: none"> • For video or film lighting • Enables quick, comprehensive control of white light via DMX or the fixture's onboard user interface • High-quality white-light output <p>The Studio Quick Setup is operational in all fixtures for excellent white light performance. It is the default setting for Series 2 Daylight HD, Series 2 Tungsten HD and Studio HD fixtures. In addition, Studio Quick Setup enables stand-alone operation from the User Interface on the back of the fixture if no console is present.</p> <p>For more information, see Studio Settings on page 68.</p>	Studio	<ul style="list-style-type: none"> • Linear dimming curve • Regulated output for brightness consistency • Variable white point 2700K–6500K • Variable + or – green (tint) with the Lustr+, Series 2 Lustr, and Studio HD

Studio Quick Setup

From the home screen:

- To adjust the **Intensity**, press [] or [].
The range is 0 to 100%.
- To adjust the **White Point**, press [] or [].
The range is 2700 to 6500K.
- To adjust the **Tint**, press [] & [] or [].
[] increases magenta and [] increases green.
- To return to the Main Menu, press [].

Advanced Settings

- 1: From the **Main Menu** press [] to scroll to **Advanced Settings**.
- 2: Press [].
- 3: Access the individual settings via additional menus.
- 4: Press [] to return to the home screen.

Once you are familiar with your fixture, you may alter any of the numerous individual settings from the Advanced Settings menu. For more information, see [Advanced Menu](#) on [page 43](#).

Chapter 2

Installation and User Interface

Specifications

Physical

- Rugged die-cast aluminum construction
- Easy-access slots for secondary lenses and standard accessories.
- Advanced thermal management systems for long LED life
- Ambient operating temperature 0°C–40°C (32°F–104°F)
- Continuous operation at 40°C (104°F)
- Hanging yoke standard
- Available in black (standard), white (optional), silver, or custom colors (contact factory)
- Features ultra-quiet cooling fan
- See [Fixture Weight](#) on [page 23](#)

Electrical

- 100V to 240V 50/60 Hz universal power input
- Includes Neutrik® powerCON® in and thru connectors
- No more than nine total Source Four LED (four total Series 2 Lustr) fixtures on Power Thru
- 5-foot Neutrik powerCON to bare-end power input lead or parallel blade U-ground (Edison) connector
- Optional 5-foot powerCON to 20A two pin and ground (stage pin) or grounded 20A twistlock connector
- Requires power from non-dimmable source

LEDs

- 60 Luxeon Rebel LED emitters (Lustr+ and Series 2 Lustr)
- 33 Osram OSLO Square and 27 Luxeon Rebel LEDs (Studio HD)
- 30 Osram OSLO Square and 30 Luxeon Rebel LEDs (Daylight HD)
- 24 Osram OSLO Square and 36 Luxeon Rebel LEDs (Tungsten HD)
- 60 Luxeon Rebel ES LED emitters (Tungsten and Daylight)
- See [Note About LED Fixtures](#) on [page 13](#)
- 50,000-hour LED life
- 20,000-hour LED life (Series 2 Lustr)

Optical

- Compatible with all ETC Source Four lens tubes. For best results, use the preferred lens tubes. See [Preferred Fixed Beam Lenses](#) on [page 15](#).

Control

- DMX512-A compliant
- DMX in and thru via 5-pin XLR connectors
- Onboard user interface with a high-resolution LCD
- Multiple profile options for different levels of control
- Optional DMX-based fan control for predictable noise levels
- Optional strobe channel
- Stand-alone, studio stand-alone, and console-free presets and sequences
- Master/slave mode
- 15-bit virtual dimming engine for smooth, high-quality theatrical fades
- See [DMX Addressing](#) on [page 26](#)

Typical Power Consumption

Lustr+

	90V	120V	240V
Idle Power / Current	4.27W / 0.084A	4.38W / 0.079A	4.2W / 0.068A
100% Boost Power / Current	130.8W / 1.48A	129.9W / 1.11A	126.4W / 0.576A

Series 2 Lustr

	90V	120V	240V
Idle Power / Current	6.77W / 0.144A	6.9W / 0.149A	6.5W / 0.155A
100% Boost Power / Current	173.0W / 1.94A	171.0W / 1.44A	168.0W / 0.783A

Studio HD

	100V	120V	240V
Idle Power / Current	5.69W / 0.096A	5.71W / 0.091A	5.35W / 0.073A
100% Boost Power / Current	129.2W / 1.3A	127.1W / 1.07A	126.2W / 0.564A

Daylight

	90V	120V	240V
Idle Power / Current	4.3W / 0.083A	4.35W / 0.077A	4.04W / 0.066A
100% Boost Power / Current	165.2W / 1.87A	163.3W / 1.39A	160.3W / 0.718A

Tungsten

	100V	120V	240V
Idle Power / Current	4.3W / 0.085A	4.35W / 0.078A	4.0W / 0.065A
100% Boost Power / Current	159.8W / 1.81A	157.4W / 1.35A	154.8W / 0.695A

Series 2 Daylight HD

	100V	120V	240V
Idle Power / Current	5.58W / 0.093A	5.69W / 0.088A	4.9W / 0.06A
100% Boost Power / Current	268W / 2.684A	265W / 2.215A	261W / 1.15A

Series 2 Tungsten HD

	100V	120V	240V
Idle Power / Current	5.64W / 0.095A	5.71W / 0.091A	4.9W / 0.061A
100% Boost Power / Current	223W / 2.219A	222W / 1.853A	217W / 0.965A

Note About LED Fixtures

All LED sources experience some lessening of light output and some color shift over time. Source Four LED Profile fixtures have complex thermal management systems to minimize these changes. With typical usage, a Series 1 fixture will still achieve at least 70% of its initial output after 50,000 hours of use (B50, L70). A Series 2 fixture will achieve 70% of its initial output after 25,000 hours of use (B50, L70). In individual situations, LEDs will be used for different durations and different levels. This can eventually lead to minor alterations in color performance, necessitating slight adjustment to presets, cues, or programs.

All LEDs may exhibit a slight shift in output as they rise to full operating temperature. Source Four LED Profile fixtures allow the selection of different power settings in order to balance the competing requirements of thermal stability and brightness. Depending on the selected setting, changes in output as fixtures warm up may or may not be visible to the eye.

Color Rendering Index and Color Quality Scale Ratings

Source Four LED Profile fixtures are evaluated for Color Rendering Index (CRI) and Color Quality Scale (CQS) performance using measured output spectrum and optimized mix solutions for a best spectral match to black body sources at 3200K and 5600K. Color fidelity is also measured. These numbers may fluctuate slightly from fixture to fixture. This is a normal characteristic of white LEDs, and this kind of variation is highly unlikely to be apparent in most applications. The performance is the same for all fixture versions.

Fixture	CRI	CQS	Color Fidelity	Duv
Lustr+ Reg at 3200K	84	87	87	0.000
Lustr+ Reg at 5600K	92	92	92	0.000
Series 2 Lustr at 3200K	86	88	88	0.000
Series 2 Lustr at 5600K	90	91	91	0.000
Studio HD at 3200K	94	95	93	0.000
Studio HD at 5600K	91	87	86	0.000
Tungsten at 3000K	86	86	86	0.001
Daylight at 5600K	71	70	69	0.001
Series 2 Daylight HD at 3200K	89	89	88	0.004
Series 2 Daylight HD at 5600K	91	89	88	0.002
Series 2 Tungsten HD at 3200K	94	91	91	0.002
Series 2 Tungsten HD at 5600K	85	86	84	0.004

Source Four LED Profile luminaires provide excellent color rendering, particularly the color-mixing versions. A Duv rating of 0.000 indicates that the color mix used was exactly on the black body line, with no green or magenta tint.

Daylight and Tungsten fixtures use only white-type LEDs at a fixed color temperature in order to maximize output and efficacy.

Installation

Basic Assembly

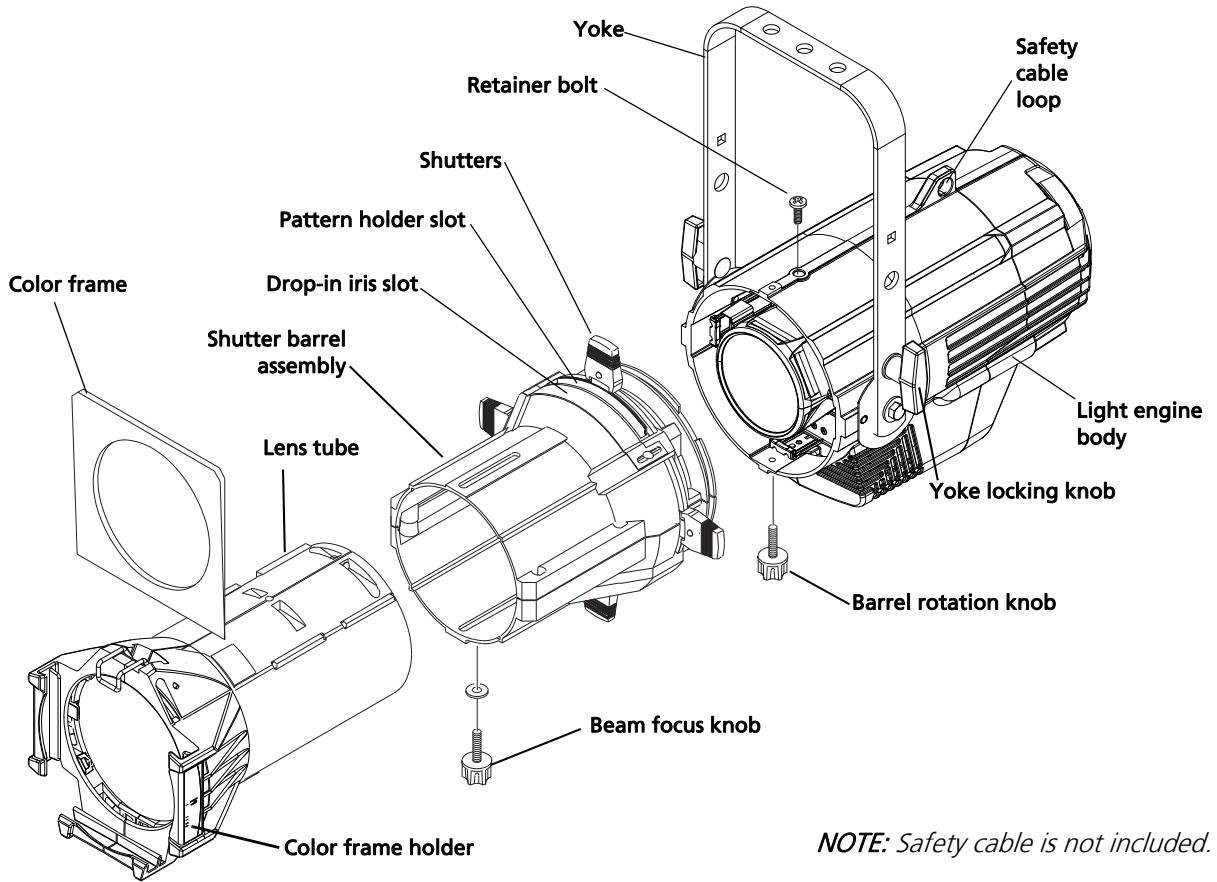

Figure-2.1 Basic assembly



WARNING: Please note the following safety warnings before use:

- Do not mount the fixture on or near combustible surfaces.
- Do not operate the fixture without a lens installed.
- Always hang the fixture with the color frame retaining clip in the locked position.
- Always use a properly installed safety cable.
- Disconnect the unit from power and DMX and allow the fixture to cool before removing or installing the shutter barrel or other adapters, and before all cleaning and maintenance.

Mounting Hardware

A yoke is provided for mounting fixtures. For more information, see [Adjust the Yoke Position](#) on [page 20](#).

Install Lens Tube

Any of the ETC Source Four lens tubes can be installed into the shutter barrel of the Source Four LED Profile. For better results, use one of the preferred lens tubes listed below.

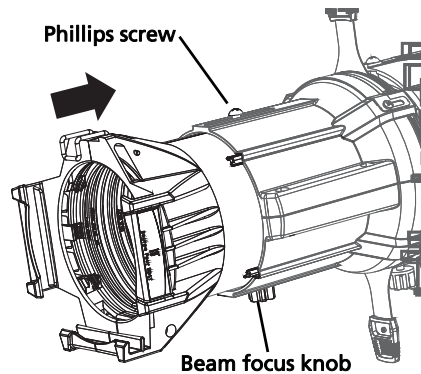

Figure-2.2 Secure lens tube with zoom knob and Phillips screw

- 1: Slide the lens tube into the shutter barrel.
- 2: Install the lens zoom knob.
- 3: Install the Phillips screw in the top of the lens barrel.

Preferred Fixed Beam Lenses

Model	Description
LED50LT	LED specific 50° EDLT with lenses installed
LED50LT-1	LED specific 50° EDLT (white) with lenses installed
436EDLT	36° EDLT w/lens installed
436EDLT-1	36° EDLT (white) w/lens installed
426EDLT	26° EDLT w/lens installed
426EDLT-1	26° EDLT (white) w/lens installed
419EDLT	19° EDLT w/lens installed
419EDLT-1	19° EDLT (white) w/lens installed
490LT	90° w/lens installed
490LT-1	90° (white) w/lens installed
470LT	70° w/lens installed
470LT-1	70° (white) w/lens installed
414LT	14° w/lens installed
414LT-1	14° (white) w/lens installed
410LT	10° w/lens installed
410LT-1	10° (white) w/lens installed
405LT	5° w/lens installed
405LT-1	5° (white) w/lens installed

Preferred Zoom Lens Assemblies

Use with light engine body without the shutter barrel.

Model	Description
41530LT	Source Four 15-30 Zoom lens assembly
42550LT	Source Four 25-50 Zoom lens assembly

Aim Adjustments

The fixture can be tilted up and down to aim the light where it is needed. The adjustment is the same for the yoke or floor stand. To assist aiming the fixture, you can turn it on without having to be connected to DMX control or enabling a preset. For more information, see *Focus* on [page 51](#).

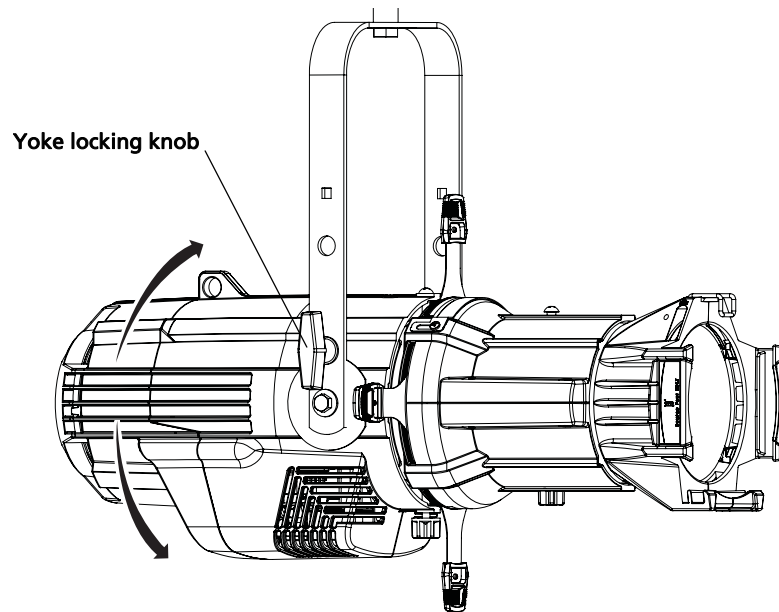

Figure-2.3 Tilting the fixture on the yoke

Turn On the Fixture

- 1: Apply power to the fixture.
- 2: On the back of the fixture press [☀].
- 3: With **Focus** selected, press [Enter].

Adjust the Tilt

- 1: Loosen the yoke locking knobs. **Do not** remove them.
- 2: Tilt the fixture to the desired position.
- 3: Tighten the yoke locking knobs to secure.

Adjust the Pan

The pan is adjusted at the hanging clamp. Please consult the clamp manufacturer's documentation for instructions on loosening and rotating the yoke at the clamp.



WARNING: A safety cable (or other approved safety device) must be securely attached to the safety cable loop before loosening the clamp.

Focus the Beam

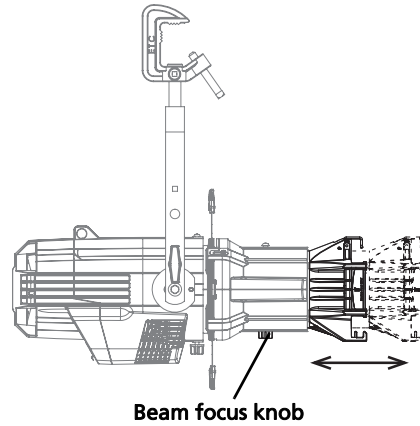

Figure-2.4 Focusing the beam

- 1: Loosen the beam focus knob located under the barrel as shown in [Figure-2.4](#).
- 2: Slide the lens tube forward or backward to achieve the desired beam edge.
- 3: Once the fixture is focused, tighten the beam focus knob.

Shape the Beam

The beam can be shaped using the shutters (see [Figure-2.1](#)), a pattern, an optional drop-in iris, or by rotating the barrel.

Add a Pattern

The pattern holder slot is on the top side of the barrel and in front of the shutters. It accommodates A-size, B-size, and glass pattern holders.

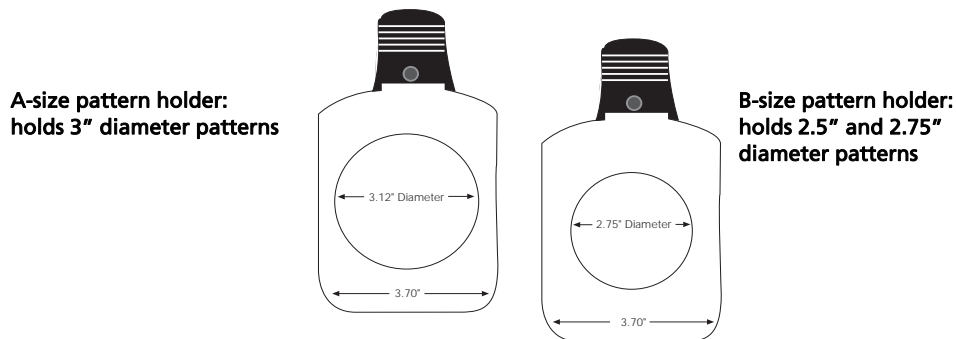

Figure-2.5 Pattern holders



Note: *Pattern projections generally look best when used with the included Soft Focus diffuser.*



Note: *Because the Source Four aperture is 3 inches wide, ETC recommends using A-size patterns for maximum pattern effectiveness.*

Install a Soft Focus Diffuser

To clean up edge effects, use the soft focus diffuser in the A-size pattern holder. If combining the diffuser with a pattern, put the diffuser behind the pattern. The soft focus diffuser allows you to maintain sharp focus of the pattern while eliminating edge effects. The diffuser is intended for Source Four LED fixtures only.

A permanent install kit is available.

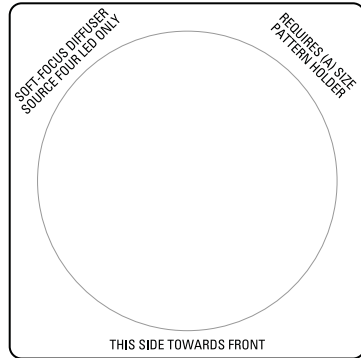

Figure-2.6 Soft focus diffuser

- 1: Install the diffuser into an A-sized pattern holder.
- 2: Install a pattern in front of the diffuser, if needed.
- 3: Insert the pattern holder and diffuser into the pattern holder slot, making sure the writing on the diffuser faces the front of the fixture.

Also see [Smooth Wash Diffuser](#) on [page 34](#).



Note: *Enhanced Definition Lens Tubes (EDLT) are highly recommend for use with Source Four LED Profile luminaires to provide a crisper pattern projection.*

Add an Accessory

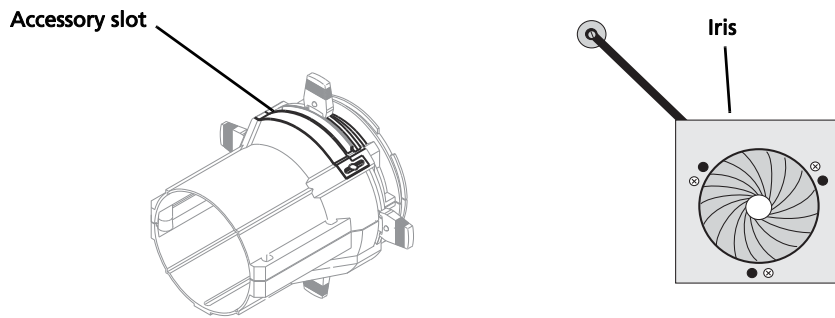

Figure-2.7 Accessory slot

The accessory slot is located on the top of the shutter barrel and in front of the pattern holder slot. It accommodates either a drop-in iris or a motorized pattern device. When the slot is not in use, a small sheet metal cover secured with two Phillips screws prevents light leakage.

- 1: Use a Phillips screwdriver to loosen the screws on the drop-in iris slot cover. Do not remove screws.
- 2: Slide the cover completely forward to expose the slot.
- 3: Insert the iris or motorized pattern device. For an iris, install the flat side toward the shutters and make sure the iris handle extends from the slot.
- 4: Slide the slot cover back toward the shutters until it meets the iris handle. Leave enough space to move the iris handle.
- 5: Secure the accessory slot cover by tightening the screws.

Rotate the Shutter Barrel Assembly

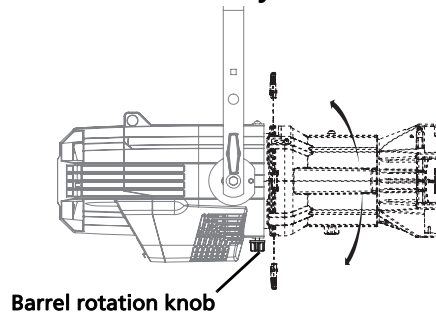

Figure-2.8 Rotating the shutter barrel assembly

- 1: Loosen the shutter barrel rotation knob directly behind the shutters on the underside of the reflector housing. **Do not** remove the barrel rotation knob.
- 2: Rotate the shutter barrel to the desired position (up to 25° in either direction from the centered position).
- 3: Once the shutter barrel is positioned, tighten the rotation knob to lock the shutter barrel in place.

Adjust the C-clamp (North America)

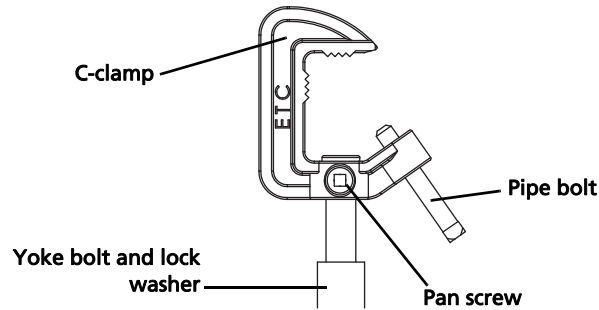

Figure-2.9 Adjusting the c-clamp

The c-clamp attaches the fixture to the mounting pipe and allows fixture adjustments when mounted.

- 1: Secure the c-clamp to the yoke with the provided yoke bolt and lock washer.
- 2: Place the c-clamp on the mounting pipe and secure by tightening the pipe bolt.
- 3: Loosen the c-clamp pan screw and rotate the yoke to the desired position.
- 4: Retighten the pan screw to lock the fixture.



CAUTION: *Tighten c-clamp pipe bolt to 15–20 ft./lbs. (approximately finger-tight plus up to one-quarter turn). Do not exceed 25 ft./lbs. Do not use excessive force.*
Tighten the yoke pivot bolt to 5–10 ft./lbs. (approximately finger-tight plus up to one-eighth turn). Do not exceed 15 ft./lbs. Do not use excessive force.

Adjust the Yoke Position

The Source Four has a two-position yoke for modifying the overall mounting height.

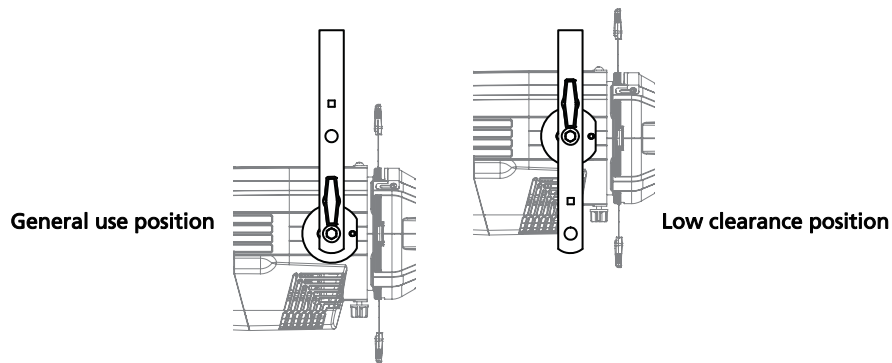

Figure-2.10 Adjusting the yoke position

- 1: Remove the yoke locking knobs, washers, and hex bolts from either side of the fixture.
- 2: Raise or lower the fixture to the desired position within the yoke.
- 3: Reinstall the yoke's hex bolts, washers, and locking knobs.
- 4: Tighten the yoke knobs to secure the fixture in position.

Installation Clearances

Cooling and Duty Cycle

Source 4 LED fixtures are fan cooled and can operate all channels at full power continuously in ambient temperatures up to 40°C (104°F).

If ambient conditions exceed 40°C (104°F) or fail to allow sufficient airflow over a long period of time, the fixtures may shut down and remain off until they return to a safe operating temperature. The fixtures provide two methods to indicate over temperature that can be set up on the Local Settings menu. The over temperature indicators are:

- **Visible:** The LED array glows in a dull, low intensity with only some emitters illuminated, the LCD backlight is turned on, the LCD displays Overtemp Activated, and the Error Indicator light turns on.
- **Dark:** The LED array turns off and the LCD displays Overtemp Activated. The LCD backlight is not turned on.



CAUTION: *Duty Cycle*

Operating the fixtures in higher ambient temperatures or low-airflow situations may cause the power supply to shut down. Following a cool-down period, the power supply will automatically reset and the fixture will return to operation.

It is good practice to power down any device with onboard electronics to limit unnecessary wear on the devices and eliminate residual use of electricity.

LED life is adversely affected by high-temperature operation. When operating under elevated ambient temperatures, avoid turning all channels to 100% for extended periods, such as channel checks or focusing.

Dimensions and Hanging Clearances

Use the following dimensions to allow proper clearances around the fixture. Allow additional space for cables.

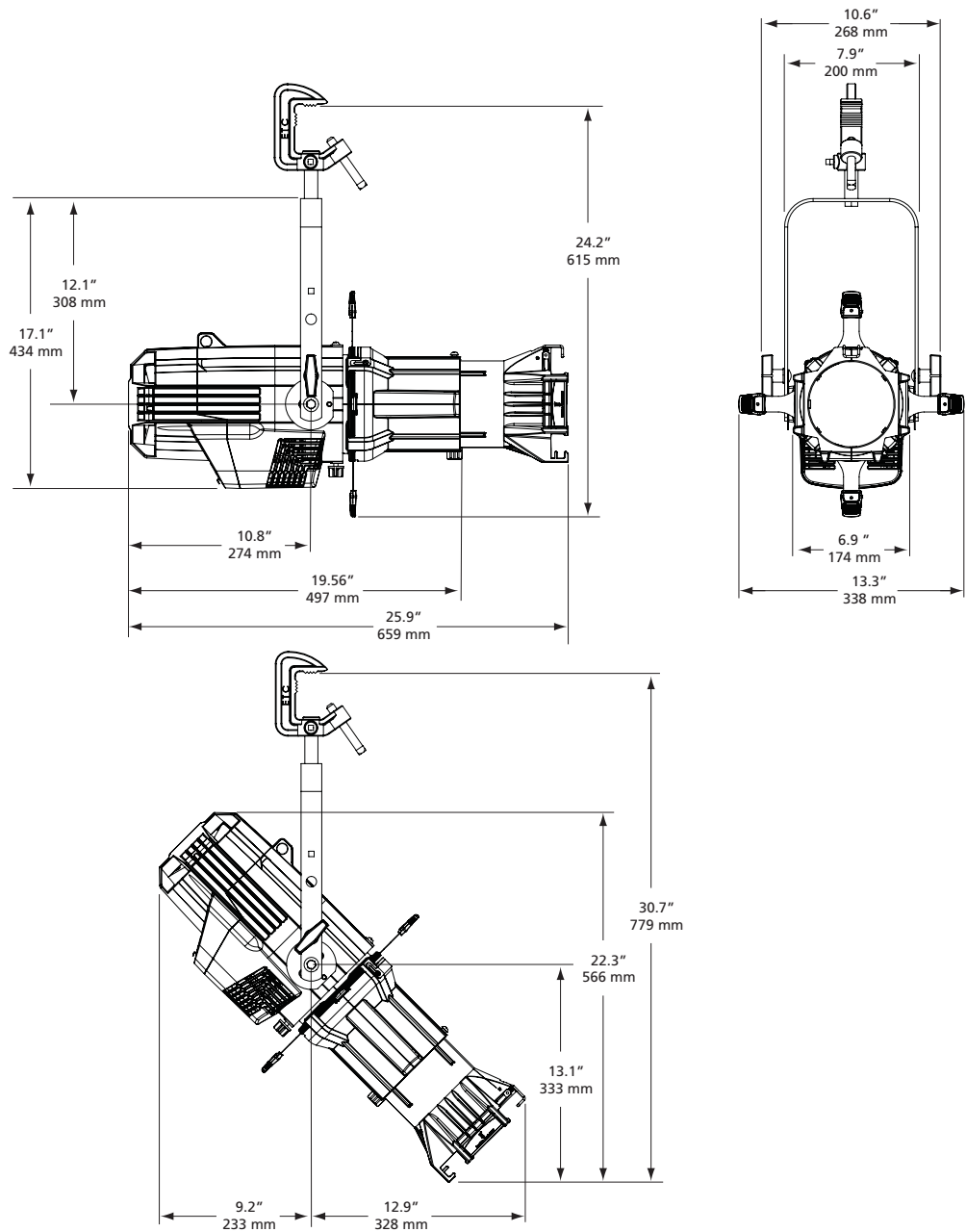

Figure-2.11 Dimensions with typical 19°, 26° or 36° lens tube fully extended. Other lens tubes available, but not shown.

Safety Cable

A safety cable (or other approved safety device) should be attached to the fixture housing and wrapped around the hanging structure (pipe). An appropriate attachment loop is provided on the protruding tab of the fixture housing. Take care to leave as little slack as possible in the safety cable to avoid the cable catching the yoke of the fixture.

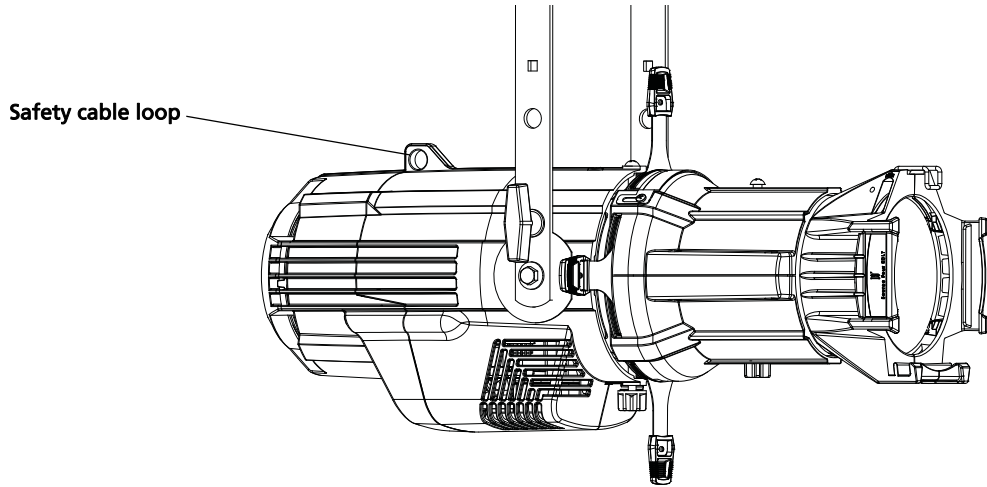

Figure-2.12 Safety cable loop on fixture housing

Fixture Weight

Total weight depends on how the individual fixture is configured.

Model	Weight ^a		Shipping Weight	
	Lb	Kg	Lb	Kg
With barrel	19.0	8.6	28.7	13.0
Without barrel	15.0	6.8	23.7	10.8

a) Does not include mounting hardware.

Power and Data Cabling Requirements

Power

The Source 4 LED fixture operates on AC power, 100–240VAC/50–60Hz. The fixture must be connected to a non-dimmable power source in order to avoid damage to its internal power supply and other electrical components.



WARNING: The fixture must be connected to a non-dimmable power source in order to avoid damage to its internal power supply and other electrical components. Dimming will damage the fixture and void the warranty.

Data

The Source 4 LED fixtures operate on a DMX control signal or as a stand-alone fixture. The fixture is supplied with a 5-pin XLR DMX Input connector and a 5-pin DMX Thru connector. DMX cables should be acceptable for DMX data transmission (not microphone cable) and should follow the standard pinout. The optional secondary data pair is not used by the Source 4 LED fixtures. The maximum DMX data run from any DMX source to the last fixture in a chain is 1000 feet (300m). Source 4 LED fixtures are self-terminated.

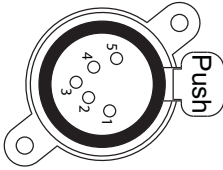
DMX512 pinout for five-pin XLR female		
	1	Common (Shield)
	2	Data –
	3	Data +
	4	not connected
	5	not connected

See [DMX Addressing](#) on [page 26](#) for additional information on DMX addressing of Source Four LED Profile fixtures.

Connections

All connections and user controls are located on the back of the fixture.

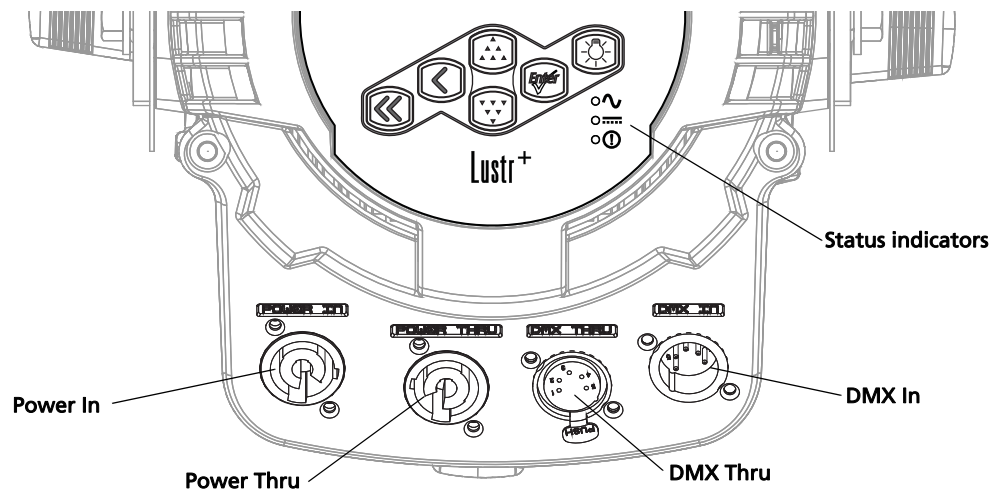

Figure-2.13 Power and DMX connections on back of fixture

Connect AC input power and DMX data cables to the appropriate ports. Connect the incoming DMX data cable to the DMX Input connector. If you are daisy-chaining the data to other fixtures or DMX-controlled devices, connect the next DMX cable to the DMX Thru connector. Up to 32 fixtures can be connected together into a data daisy-chain.

For information about the user interface, refer to [User Interface Overview](#) on [page 35](#).

Source Four LED Series Connections

- **Connect the AC cable:** Align and insert the power connector. Twist the connector clockwise until it locks into place.
- **Disconnect the AC cable:** Slide back the locking tab to unlock, twist the connector counterclockwise, and then pull and disconnect the power connector.
- **Connect the DMX cable:** Align and insert the DMX connector.
- **Disconnect the DMX cable:** Press the release button on the connector or on the fixture and pull the connector out.

Indicator Lights

The indicator lights show the status of power input (blue), DMX input (green), and fixture errors (red). When the DMX signal is lost, the green indicator flashes.

If the fixture status indicator is configured to Off, the indicator lights will not illuminate. For more information, see [Local Settings](#) on [page 65](#).

DMX Addressing

Addresses must be set between 1 and 510.

Each Source Four LED Profile fixture must be considered a separate DMX device for the purpose of DMX line-loading calculations.

DMX line-loading practice dictates that no more than 32 devices can be daisy-chained together. Consequently, no combination of Source Four LED Profile fixtures totaling more than 32 DMX devices should be configured in one DMX line. For runs of fixtures totaling more than 32 DMX devices, split the DMX runs by using a DMX splitter.



Note: *Depending on the selected fixture profile and activated features, a fixture with a starting address higher than 499 may not have control of all parameters, even though the highest address shown on the user interface is 512. Addressing is not required for stand-alone operation.*

DMX Profiles

Source Four LED and Source Four LED Series 2 fixtures occupy 1 to 15 DMX channels depending on the profile and which features are turned on. The tables below describe the order and function of each channel.

Lustr+, Series 2 Lustr, Series 2 Daylight HD, Series 2 Tungsten HD, and Studio HD

Direct Control

Direct Control uses one DMX channel per individual color within the LED array for a total of seven color channels, arranged according to the [Color Mixes](#) table. Each controls the intensity of the color from 0 to 100%. An additional 8th DMX channel is used as a master intensity fader for controlling the brightness of the overall fixture. Channel 9 is for strobe, when enabled.

Data Channel	Control	Value	Function
1	Fixture address	Color 1 ^a	Color intensity 0 to 100%
2	Fixture address + 1	Color 2 ^a	
3	Fixture address + 2	Color 3 ^a	
4	Fixture address + 3	Color 4 ^a	
5	Fixture address + 4	Color 5 ^a	
6	Fixture address + 5	Color 6 ^a	
7	Fixture address + 6	Color 7 ^a	
8	Fixture address + 7	Intensity	Overall intensity 0 to 100%
9	Fixture address + 8	Strobe	Variable strobe control

a) See [Color Mixes](#) on [page 27](#).

Color Mixes

The following table shows the color mixes for the fixture.

Color	Lustr+	Series 2 Lustr	Studio HD
1	Red	Red	Red
2	White	Lime	Red Orange
3	Amber	Amber	Mint
4	Green	Green	Blue
5	Cyan	Cyan	Indigo
6	Blue	Blue	—
7	Indigo	Indigo	—

HSI and HSIC

The **HSI** profile (Hue, Saturation, Intensity) uses four channels of DMX input, corresponding to 16-bit hue (two channels: coarse and fine), saturation, and intensity. The HSI profile makes Source Four LED Profile fixtures compatible with conventional HSI console profiles while capitalizing on fixtures' expanded color capabilities. Channel 5 is for Strobe, when enabled. Also see [Color Matching](#) on [page 29](#).

The **HSIC** profile (Hue, Saturation, Intensity, Color Temperature (White Point)) is similar to HSI, except that it uses an additional sixth channel to control the color temperature of the white point. The Red Shift function is automatically disabled in the HSIC profile.

Data Channel		Control	Value	Function
1	Fixture address	Hue coarse	0 to 65535	Hue 0
2	Fixture address + 1	Hue fine		
3	Fixture address + 2	Saturation	0 to 255	Saturation 0 to 100%
4	Fixture address + 3	Intensity		Intensity 0 to 100%
5	Fixture address + 4	Strobe		Variable strobe control
6	Fixture address + 5	Fan control		Force fan on various speeds
7	Fixture address + 6	White point		Color temperature 2000–8375K



Note: *The HSI profile is optimized for maximum brightness at all settings.*

RGB

The RGB profile effectively addresses all seven colors via three channels of control. The RGB profile produces medium-quality color crossfades. It makes the Source Four LED Profile fixtures compatible with conventional RGB console profiles while maintaining enhanced color production from the fixture. Also see [Color Matching](#) on [page 29](#).

Data Channel		Control	Value	Function
1	Fixture address	Red	0 to 255	Intensity 0 to 100%
2	Fixture address + 1	Green		
3	Fixture address + 2	Blue		
4	Fixture address + 3	—	—	—
5	Fixture address + 4	Strobe	0 to 255	Variable strobe control
6	Fixture address + 5	Fan control		Force fan on various speeds



Note: *The RGB profile is optimized for maximum brightness at all settings. Occasionally small changes in RGB values may produce unexpected jumps in brightness. Shifts in brightness may be perceived during color crossfades in cues and presets.*

Studio

The fixture produces only white-type light, which is adjustable from 2725 to 6450K. The Studio profile uses three DMX channels to control intensity, white point (color temperature when saturation is at 0%), and tint (balance between green and magenta). Tint is adjustable without affecting the white point. All three control parameters are adjustable via DMX as well as onboard with instant access via user interface buttons.

For more information, see [Studio Settings](#) on [page 68](#). Also see [Color Matching](#) on [page 29](#).

Data Channel		Control	Value	Function
1	Fixture address	Intensity	0 to 255	Intensity 0 to 100%
2	Fixture address + 1	White point: 2725 to 6450K		0 to 1 = 3200K 2 to 253 = Adjustment from 2725 to 6450K 254 to 255 = 5600K
3	Fixture address + 2	Tint		0 to 1 = neutral white 2 to 127 = full plus-green to neutral white 128 = neutral white 129 to 255 = neutral white to full minus-green (full magenta)
4	Fixture address + 3	—	—	—
5	Fixture address + 4	Strobe	0 to 255	Variable strobe control
6	Fixture address + 5	Fan control		Force fan on various speeds

Strobe

In most profiles, strobe is assigned to channel 5. It adds another channel to any of the DMX profiles. Under the Advanced Settings menu, the strobe function may be disabled and the additional channel for strobe will not be used by the fixture. With strobe at either DMX value 0 or 255, the fixture output is constantly on. At DMX 1, the fixture strobos slowly and increases in speed toward DMX 254.

Plus Seven

Plus Seven adds precision color-control override channels to the HSI, HSIC, RGB, and Studio profiles. When in one of the above profiles, enabling Plus Seven adds an additional seven channels to the profile (i.e., HSI profile with Plus Seven becomes a 15-channel profile). To enable Plus Seven, place the Plus Seven Control channel at a value above 51%.

When using Plus Seven, the desired color and intensity is selected by using the HSI or RGB channels as a starting point. From there, the additional seven channels represent an individual control channel for each of the native LED colors of the fixture and allow you to adjust each LED color up or down to fine-tune the overall color output.

The first additional channel is an activation channel for the Plus Seven function. A value of 0 to 50% (DMX 0 to 129) deactivates Plus Seven. A value of 51 to 100% (DMX 130 to 255) activates Plus Seven. The remaining 7 additional channels correspond to the individual colors within the fixture's LED array.



Note: Depending on the initial color mix, some LED colors may begin at full intensity. Moving the individual control channels for these colors from 128 to 255 (50–100%) will produce no effective change from the initial color mix. Conversely, some LED colors may begin at zero intensity, and moving individual control channels from 128 to 0 (50–0%) will produce no change.



Note: When Plus Seven is enabled and the individual control channels have been adjusted, those adjustments continue to apply after choosing a new color mix. For best results, reset each of the individual control channels to 128 (50%) before choosing a new initial color mix.

	Data Channel	Control	Value	Function
8	Fixture address + 7	Plus Seven control	0 to 129 = Plus Seven disabled 130 to 255 = Plus Seven enabled	Disable or enable Plus Seven control
9	Fixture address + 8	Color 1 ^a	128 = No change from initial color mix 129 to 255 = Increase from starting value to full intensity 127 to 0 = Decrease from starting value to zero intensity	Alter the individual LED colors within the array to a maximum of full intensity or a minimum of zero intensity.
10	Fixture address + 9	Color 2 ^a		
11	Fixture address + 10	Color 3 ^a		
12	Fixture address + 11	Color 4 ^a		
13	Fixture address + 12	Color 5 ^a		
14	Fixture address + 13	Color 6 ^a		
15	Fixture address + 14	Color 7 ^a		

a) See [Color Mixes](#) on [page 27](#).

Color Matching

The color output of all Source Four LED Profile fixtures is calibrated at the factory. When operating in the RGB, HSI, HSIC, or Studio profile, each fixture makes accommodations for the specific LEDs in its array and produces output that is consistent with other fixtures, whether or not they utilize LEDs from the same production batch. Operating in the Direct Control profile or with Plus Seven settings adjustments bypasses this calibration and multiple fixtures may produce slightly different outputs when controlled as a group.

Daylight and Tungsten

Direct Control

The first DMX channel always controls Intensity from 0 to 100%.

	Data Channel	Control	Value	Function
1	Fixture address	Intensity	0 to 255	Intensity 0 to 100%
2	Fixture address + 1	Strobe		Variable strobe control
3	Fixture address + 2	Fan control		Force fan on at various speeds

Fan Control

The Fan setting allows four options: DMX, Slow, Fast, and Automatic.

With Fan set to DMX, an additional channel of DMX control is added to the fixture profile. This channel immediately follows the channel for Strobe. Control is as follows:

- **DMX 0:** Fan turns on and off automatically, as needed for cooling. Fan remains off when not required by the fixture.
- **DMX 1 to 254:** Fan is forced on at a continuously variable speed from low to high. Occasionally, the fan speed may be increased automatically by the fixture for additional cooling power when required.
- **DMX 255:** Fan is forced on at its highest, loudest speed for maximum consistency of noise produced by the fixture.

When Fan is set to Slow, Fast, or Automatic, there is not a channel designated for control within the DMX profile. At Slow and Fast settings, the fan operates whenever the fixture is powered on, independent of other fixture settings or control.

- **Slow:** Fan runs continuously at a low-noise speed. When deemed necessary by the fixture, the fan speed may be increased automatically for additional cooling power.
- **Fast:** Fan runs continuously at its highest and loudest speed, and never increases automatically.
- **Automatic:** Fan operation is intermittent and based on the fixture's internally calculated cooling requirements.

DMX Profile Tables

Lustr+ and Series 2: Lustr, Daylight HD, Tungsten HD, and Studio HD

DMX Profile	DMX Channels	Channel Assignments	Notes
Direct	10	See Channel Assignments in Direct Mode on page 33	Direct control of each individual color with a separate master intensity channel. Color calibration of LEDs is not active in this mode. The ten-channel profile will produce the highest quality color crossfades.
RGB	6 (Ch. 4 not used)	1 - Red	Effectively addresses all seven colors via three channels of control. RGB profile will produce medium quality color crossfades.
		2 - Green	
		3 - Blue	
		4 - n/a	
		5 - Strobe	
		6 - Fan Control	
HSI	6	1 - Hue (coarse)	High resolution hue (two channels), saturation, and intensity control. HSI mode will produce color crossfades around the color space.
		2 - Hue (fine)	
		3 - Saturation	
		4 - Intensity	
		5 - Strobe	
		6 - Fan Control	
HSIC	7	1 - Hue (coarse)	High-resolution hue, saturation, and intensity control as above, with the addition of a color point channel to adjust the color temperature of the fixture in both white light and color. Color crossfade performance is the same as HSI.
		2 - Hue (fine)	
		3 - Saturation	
		4 - Intensity	
		5 - Strobe	
		6 - Fan Control	
		7 - Color Point (CCT)	
Studio	6 (Ch. 4 not used)	1 - Intensity	Controls fixture as a white light unit. If no DMX is present, (i.e., console input), a fixture can be adjusted for these three parameters on the user interface at the back of the unit.
		2 - Color Point (CCT)	
		3 - Tint	
		4 - n/a	
		5 - Strobe	
		6 - Fan Control	

DMX Profile	DMX Channels	Channel Assignments	Notes
Plus Seven	7 additional channels	See Plus Seven Profile Options on page 33	<p>Adds seven additional color control channels in RGB, HSI, and HSIC input profile settings. For example, HSI with 'Plus Seven' enabled becomes a 15-channel profile.</p> <p>The desired color and intensity are achieved by using the HSI or RGB channels</p> <p>Placing the Plus Seven channel at a value over 51% gives the fixture additional channels in its profile.</p> <p>Channels 9–15 represent the native colors of the fixture and allow the operator to adjust individual color channels to fine tune the color output.</p>
Strobe	1 additional channel		Variable strobe control: 0% is no strobe. The fixture output will strobe more rapidly as the strobe channel value approaches 100%.

Tungsten and Daylight

DMX Profile	DMX Channels	Channel Assignments	Notes
Studio	3	1 - Intensity	Control of parameters is also enabled from the luminaire's user interface. No console is required.
		2 - Strobe	
		3 - Fan Control	
Direct	3	1 - Intensity	
		2 - Strobe	
		3 - Fan Control	

Channel Assignments in Direct Mode

Channel Number	Series 1 Studio HD	Series 1 Lustr+	Series 2 Lustr	Series 2 Daylight HD	Series 2 Tungsten HD
1	Red	Red	Red	Red	Red
2	Red Orange	White	Lime	(not used)	Red Orange
3	Mint	Amber	Amber	Mint	Mint
4	Blue	Green	Green	Blue	Blue
5	Indigo	Cyan	Cyan	Indigo	Indigo
6	n/a	Blue	Blue	(not used)	(not used)
7	n/a	Indigo	Indigo	(not used)	(not used)
8	Intensity	Intensity	Intensity	Intensity	Intensity
9	Strobe	Strobe	Strobe	Strobe	Strobe
10	Fan Control	Fan Control	Fan Control	Fan Control	Fan Control

Plus Seven Profile Options

Channel Number	Series 1 Studio HD	Series 1 Lustr+	Series 2 Lustr	Series 2 Daylight HD	Series 2 Tungsten HD
1	Hue (coarse)	Hue (coarse)	Hue (coarse)	Intensity	Intensity
2	Hue (fine)	Hue (fine)	Hue (fine)	White Point	White Point
3	Saturation	Saturation	Saturation	Tint	Tint
4	Intensity	Intensity	Intensity	(not used)	(not used)
5	Strobe	Strobe	Strobe	Strobe	Strobe
6	Fan Control	Fan Control	Fan Control	Fan Control	Fan Control
7	(not used)	(not used)	(not used)	(not used)	(not used)
8	Plus Seven Control on/off	Plus Seven Control on/off	Plus Seven Control on/off	Plus Seven Control on/off	Plus Seven Control on/off
9	Red	Red	Red	Red	Red
10	Red Orange	White	Lime	(not used)	Orange
11	Mint	Amber	Amber	Mint	Mint
12	Blue	Green	Green	Blue	Blue
13	Indigo	Cyan	Cyan	Indigo	Indigo
14	(not used)	Blue	Blue	(not used)	(not used)
15	(not used)	Indigo	Indigo	(not used)	(not used)

DMX Footprints and Channel Mapping

Daylight and Tungsten

Channel	Control
1	Intensity
2	Strobe*
3	Fan control*

Lustr+ and Series 2: Lustr, Studio HD, Daylight HD, and Tungsten HD

Channel	HSI	HSIC	RGB	Studio	Direct
1	Hue	Hue	Red	Intensity	Color 1
2	Hue fine	Hue fine	Green	Color temp	Color 2
3	Saturation	Saturation	Blue	Tint	Color 3
4	Intensity	Intensity	N/A	N/A	Color 4
5	Strobe*	Strobe*	Strobe*	Strobe*	Color 5
6	Fan control*	Fan control*	Fan control*	Fan control*	Color 6
7	N/A	Color temp	N/A	N/A	Color 7
8	Plus Seven on/off*	Plus Seven on/off*	Plus Seven on/off*	Plus Seven on/off*	Intensity
9	Plus Seven - (1)*	Plus Seven - (1)*	Plus Seven - (1)*	Plus Seven - (1)*	Strobe*
10	Plus Seven - (2)*	Plus Seven - (2)*	Plus Seven - (2)*	Plus Seven - (2)*	Fan control*
11	Plus Seven - (3)*	Plus Seven - (3)*	Plus Seven - (3)*	Plus Seven - (3)*	N/A
12	Plus Seven - (4)*	Plus Seven - (4)*	Plus Seven - (4)*	Plus Seven - (4)*	N/A
13	Plus Seven - (5)*	Plus Seven - (5)*	Plus Seven - (5)*	Plus Seven - (5)*	N/A
14	Plus Seven - (6)*	Plus Seven - (6)*	Plus Seven - (6)*	Plus Seven - (6)*	N/A
15	Plus Seven - (7)*	Plus Seven - (7)*	Plus Seven - (7)*	Plus Seven - (7)*	N/A

* When this feature is enabled.

Install Accessories

Color Frame Holder

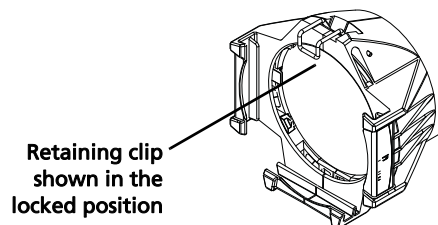

Figure-2.14 Color frame holder and retaining clip

The gel frame holder is equipped with a spring-loaded retaining clip that prevents gel frames and accessories from falling out.



WARNING: Make sure all color frames and accessories are locked in position with the retaining clip before hanging the fixture.

- 1: Release the retaining clip by pushing it sideways while gently pulling backwards.
- 2: Insert the color frame or other accessory.
- 3: Lock the retaining clip by pushing sideways while gently pushing forward.

Smooth Wash Diffuser

To reduce edge effects and provide better overlap when using the fixture for wash, use a smooth wash diffuser. If this diffuser is used, it is recommended to not use the soft focus diffuser in the pattern holder. See [Install a Soft Focus Diffuser](#) on [page 18](#).

Chapter 3

Basic Menu Navigation

User Interface Overview

The Source Four LED Profile user interface (UI) consists of an LCD and keypad. All of the basic information is displayed on the LCD and the keypad is used to navigate through the menus. Use the LCD and keypad to program the fixture for your specific application.

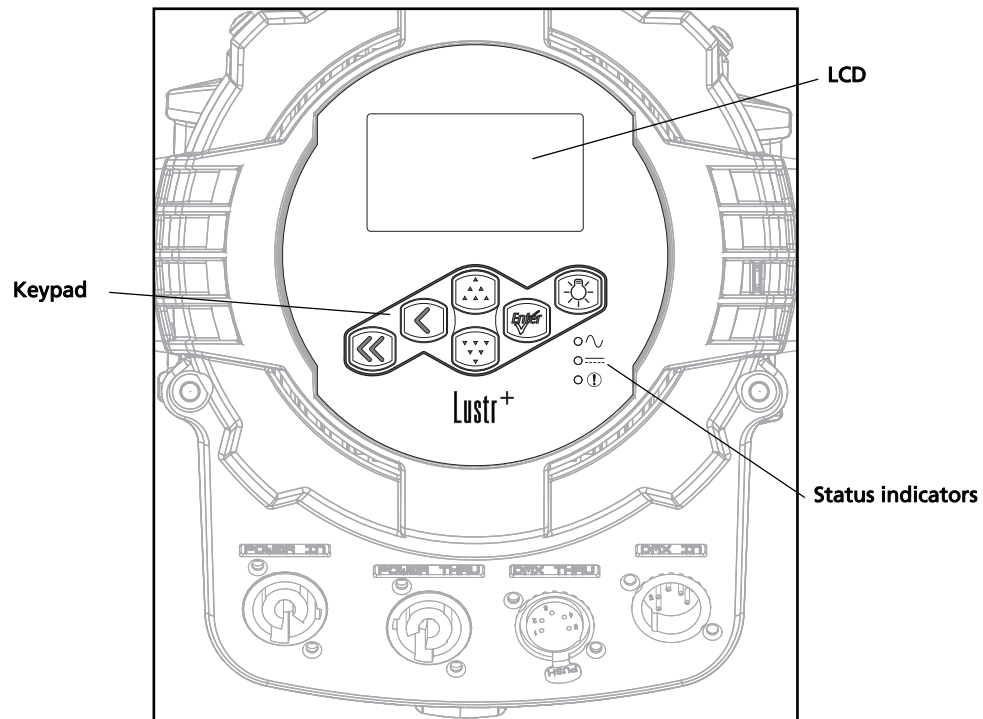

Figure-3.1 User interface on back of fixture

LCD

The Source Four LED Profile fixture features a backlit LCD capable of displaying 8 rows of text with 21 characters per line. The first row is reserved for the menu title.

Adjust the contrast of the LCD

Press and hold [<] and then press [▲▲▲] or [▼▼▼] repeatedly until the desired contrast is achieved.

Keypad

Use the keypad buttons to access and navigate the menus on the LCD.

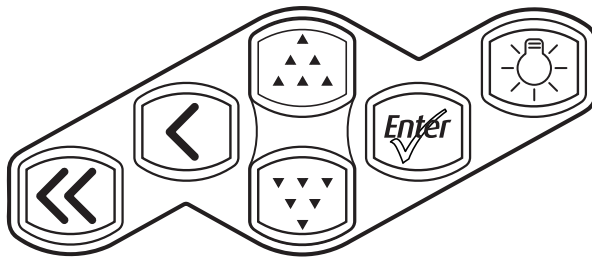

Figure-3.2 Keypad buttons



Home
Opens the home screen.



Back
Cancels the current operation and returns to the previous screen. Multiple presses of the back button will eventually take you to the status display.



Up
Increases a value or menu choice by one. Pressing and holding the button increases the rate of change.



Down
Decreases a value or menu choice by one. Pressing and holding the button increases the rate of change.



Light Bulb
Opens the Presets and Sequences menu.

Enter



- Activates a menu selection or stores a value. For most settings, press repeatedly to scroll through available options while the setting is highlighted, and then press or to commit the change and move to a different setting.
- Certain settings require the selection of a numeric value. Press once to highlight the number, press or to reach the desired value, and then press to commit the change.



Note: *When the fixture is in the stand-alone mode of the Studio profile, the functionality of the buttons changes. For more information, see [Operation From Home Status Screen \(Studio Stand-alone\)](#) on page 69.*

Keypad Lockout

The keypad may be locked to prevent unauthorized access to fixture settings. Press and simultaneously for approximately 3 seconds. A small padlock icon appears in the corner of the LCD screen to indicate that the keypad is locked. To unlock, again press and simultaneously for approximately 3 seconds. The padlock icon disappears. The locked or unlocked status of the keypad persists through on/off power cycles. Keypad lockout does not affect access to fixture settings via RDM.

Status Indicators

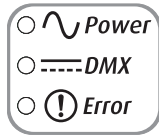

Figure-3.3 Status Indicators on the back of the fixture

The status indicators are three small, colored LEDs on the user interface that indicate the status of:

- **Power:** Illuminates blue when AC power is supplied to the fixture.
- **DMX:** Illuminates solid green when an active DMX signal is being received by the fixture. The LED blinks when no DMX is present.
- **Error:** Illuminates red only when the fixture is experiencing a data error, high internal temperature, or other abnormal condition.

Status indicators are on by default. You can turn them off through the Local Settings menu. For more information, see [Local Settings](#) on [page 65](#).

Screen Navigation

When the Source Four LED Profile fixture is powered up, a splash screen briefly displays, followed by a status screen.

The menu system and LCD backlight are set, by default, to “sleep” after one minute of inactivity. Any button press wakes the LCD backlight. You can set the inactivity time on the Local Settings menu. To “wake up” the display and go to the button’s respective function, press any keypad button. For example, if you press , the LCD backlight comes on and the Main Menu displays. For more information, see [Local Settings](#) on [page 65](#).

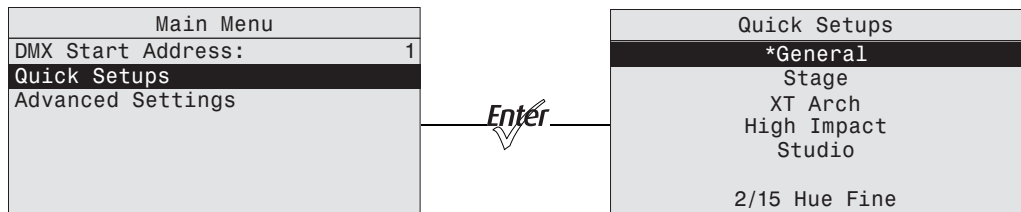

Figure-3.4 Main Menu with Quick Setups selected and the result of pressing Enter. Lustr+ screen shown.

Press  or  to highlight a menu item. Press  to select the item. The asterisk (*) indicates that the item is currently active.

Status (Home) Screens

The status (home) screens display when you press [<<<] or when there is no activity for a specific time, which you set in Local Settings. For more information, see [Local Settings](#) on [page 65](#). The home screens display the status of multiple fixture settings. These may or may not include:

- Quick Setup
- Input settings
- DMX address
- LED settings
- Preset or Sequence that may be active
- Master or Slave status, when applicable
- Diagnostic messages
- DMX signal status
- Software version

Most of the settings can be adjusted either on the home screen or within a short series of menus. When a quick setup is selected, the settings of the setup are displayed on the home screen.

For more information about status screens, see [Home Screen Displays](#) on [page 40](#).

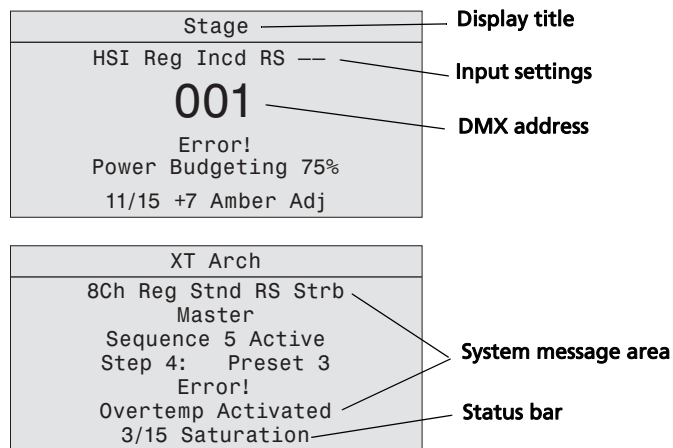

Figure-3.5 Examples of status screens

Display Title

A menu's title appears in the first row of every display for easy navigation.

Input Settings

Displays the parameters for the Quick Setup that is active. For more information, see [Home Screen Displays](#) on [page 40](#).

DMX Address

Indicates the DMX address when the fixture is receiving DMX. For more information, see [DMX Start Address](#) on [page 41](#).

System Message Area

Displays status messages, which vary depending on the function that is currently active.

Master or Slave

Indicates if the fixture is the master or slave when the a string of fixtures is running together in stand-alone operation. For more information, see [Master/Slave Operation](#) on [page 61](#).

Sequence

Indicates whether or not a sequence is active and if so, which sequence is active. For more information, see [Presets & Sequences](#) on [page 51](#).

Step

Indicates whether or not a preset is active and if so, which step and preset is active. For more information, see [Presets & Sequences](#) on [page 51](#).

Preset

Indicates which preset is currently active. For more information, see [Presets & Sequences](#) on [page 51](#).

Error

Displays error messages. Refer to [Error Messages on page 72](#) for a complete listing of possible errors and the actions required to clear them.

Status Bar

Indicates the DMX channels, type, and effect the setup uses.

Menu Navigation

The menu is designed with consistent navigation from the user interface (UI) using the keypad.

The Main Menu is the root for all menu navigation. When an item is selected from the Main Menu, a secondary menu displays, which includes multiple functions for selection. Some secondary menus lead to additional menus. Select a menu item to edit its settings or to proceed to a deeper menu. Items that may be edited are indicated with descriptive text followed by a colon (:) and a value.

The keypad is used to edit specific objects on the operation menu, such as DMX address, Preset and Sequence numbers, fade and delay times, etc. Once an edit has been made, press [**Enter**] to accept the selection.

Use [**Enter**] to navigate to the next object for action or edit. To return to the previous operation, press [<]. Continue pressing [<] to return to the menu list and then the Main Menu.

You can also use [<] with any Yes or No dialog box. Pressing [<] is the same as selecting No.

Chapter 4

Operation

Home Screen Displays

Depending on the fixture settings, the following are displayed in the system message area on the respective home (status) screens.

All Fixtures (Excluding Daylight and Tungsten)

Parameter	Stage	XT Arch	High Impact	Studio	General
Profile	HSI	HSI	RGB	Studio	Direct Control (Dir)
Output Setting	Regulated (Reg)	Protected (Prt)	Boost (Bst)	Regulated (Reg)	Regulated (Reg)
Dimming Curve	Incandescent (Incd)	Standard (Std)	Quick (Qik)	Linear (Lin)	Standard (Std)
Red Shift (RS)	Enabled	Disabled	Disabled	Disabled	Disabled
Strobe (Str)	On	On	On	On	On

Daylight and Tungsten Fixtures Only

Parameter	Studio	Stage	Single Channel
Profile	Studio	Direct	Direct
Output Setting	Regulated (Reg)	Regulated (Reg)	Regulated (Reg)
Dimming Curve	Linear (Lin)	Incandescent (Incd)	Standard (Std)
Strobe (Str)	On	On	Off
Fan Control	DMX	DMX	Automatic (Auto)

Profile (Excluding Daylight and Tungsten)

The control profile defines the number and control parameter assignments of input channels for intensity and color-control. For more information, see [DMX Profiles](#) on [page 26](#).

Profile (Daylight and Tungsten only)

The control profile for Daylight and Tungsten includes only the Direct or Studio options. The first channel of DMX control adjusts fixture Intensity from 0 to 100%. For more information, see [Daylight and Tungsten](#) on [page 30](#).

Output Setting

Output is the way and amount to which the fixture constrains the overall power going to the LED array, which determines how consistent the fixture's brightness may be. For more information, see [Output](#) on [page 47](#).

Dimming Curve

Dimming curve is the way that the fixture responds to changes in the control signal for overall intensity. For more information, see [Curve](#) on [page 48](#).

Red Shift

Red shift replicates the warming of an incandescent filament's color temperature change as it dims. For more information, see [Red Shift](#) on [page 50](#).

Strobe

Strobe flashes the output of the LED array. For more information, see [Strobe](#) on [page 44](#).

Fan Control

The fan can be forced on via DMX control or by adjusting settings under the Advanced Settings menu. For more information, see [Fan Control](#) on [page 30](#).

Thermal Shutdown Warning

Displayed as OverTemp, it is what the fixture does to visibly warn you that it has become overheated and has gone into a shutdown status, which is maintained until the fixture returns to a safe operating temperature. For more information, see [OverTemp](#) on [page 67](#).

Data Loss Behavior

What happens to the fixture's output when the external control signal is lost. For more information, see [Data Loss](#) on [page 44](#).

Status Indicators

Status Indicators are on by default. For more information, see [Status Indicators](#) on [page 66](#).

Main Menu

The Main Menu can be accessed at any time while viewing other screens. To access the **Main Menu**, press [<<] and then press [*Enter*].

DMX Start Address

Use the DMX Start Address to set the DMX address of the fixture. Also see [DMX Settings](#) on [page 43](#).



Figure-4.1 Selecting DMX Start Address on the Main Menu.

- 1: On the **Main Menu**, scroll to **DMX Start Address**.
- 2: Press [*Enter*] to select the address number.
- 3: Use [*▲▲▲*] or [*▼▼▼*] to scroll to the desired **address**.
- 4: Press [*Enter*].
- 5: Press [<<] to return to the home screen.

Quick Setups

Quick Setups are groupings of predefined fixture performance settings, based on typical applications.

Use the Quick Setups menu to select the desired setup. When a setup is active, the status bar at the bottom of the screen indicates the DMX channels, their functions, and arrangements that the setup uses. For descriptions of the different Quick Setups, see [Use Quick Setups on page 8](#).



Figure-4.2 Selecting Quick Setup on the Main Menu

- 1: On the **Main Menu**, scroll to **Quick Setups**.
- 2: Press [Enter].
- 3: Scroll to the desired profile and then press [Enter].
An asterisk (*) next to the profile name indicates that profile is active.
- 4: Press [⏪] to return to the home screen.
The top line of the home screen displays the name of the active profile.

Advanced Settings

The Advanced Settings menu is for experienced users or for applications that entail very carefully defined performance parameters. You can make individual adjustments of all fixture settings for customized control.



Figure-4.3 Advanced Menu from the Main Menu

When opening Advanced Settings, all fixture settings remain at their most recent values until readjusted. The fixture automatically goes into Advanced Settings when any settings are altered from one of the preset Quick Setups. Copy All Settings appears on the screen only when DMX is not present.

Advanced Menu

The Advanced Menu provides access to various fixture settings and specific operations. The Advanced Menu is accessed from the **Main Menu** by pressing [**▲▲▲**] or [**▼▼▼**] to select **Advanced Settings** and then pressing [**Enter**].

Copy All Settings appears on the screen only when DMX is not present. See [Copy All Settings](#) on [page 68](#).

DMX Settings

The current DMX settings are shown in the DMX Settings screen. Use the DMX Settings screen to customize the following:

- DMX start address
- DMX profile
- Strobe
- Data loss
- Plus Seven (excluding Daylight and Tungsten)

The two lower lines of the DMX Settings screen display the number of DMX channels used by the fixture, according to the options selected, and their arrangement, in order.



Figure-4.4 Selecting DMX Settings from the Advanced Menu

DMX Start Address

The DMX start address is selectable from 1 to 512.

- 1: On the **Advanced Menu**, scroll to **DMX Settings**.
- 2: Press [**Enter**].
- 3: With **DMX Start Address** selected, press [**Enter**] to select the value.
- 4: Then press [**▲▲▲**] or [**▼▼▼**] to set the desired address.
- 5: Press [**Enter**].



Note: *A change to the DMX start address on this screen will override and update the DMX start address selected on the Home screen.*

DMX Profile

The current DMX profile is displayed on the DMX Settings menu. You can customize the setting by selecting a different profile. For detailed information about each profile, see [DMX Profiles](#) on [page 26](#).

- 1: On the **DMX Settings** menu, scroll to **DMX Profile**.

DMX Settings	
DMX Start Address:	101
DMX Profile:	HSIC
Strobe:	On
Data Loss:	Instant
Plus Seven:	On
Fan Mode:	DMX
3/15 Saturation	

Figure-4.5 Selecting DMX Profile on the DMX Settings Menu

- 2: Press [**Enter**] to set the desired profile.

Strobe

Strobe adds another DMX channel of control at channel 5 (or channel 9 when operating in Direct Control profile). When enabled, the Strobe channel controls the fixture output as follows.

DMX Value	Strobe Effect
0	Full on
1 to 254	Variable rate from slow to fast
255	Full on

- 1: On the **DMX Settings** menu, scroll to **Strobe**.

DMX Settings	
DMX Start Address:	101
DMX Profile:	HSIC
Strobe:	On
Data Loss:	Instant
Plus Seven:	On
Fan Mode:	DMX
5/15 Strobe	

Figure-4.6 Enabling Strobe on the DMX Settings Menu.

- 2: Press [**Enter**] to toggle between **On** and **Off**.
- 3: Press [**▲▲▲**] or [**▼▼▼**] to commit the option.

Data Loss

Data Loss is what happens to the fixture's output when the external control signal (either DMX or data from the Master fixture in a Master/Slave configuration) is lost. The choices are as follows:

Instant

As soon as the control signal is lost, the fixture shuts off output and the LED array goes black.

HLL-2Min

Hold last look for 2 minutes. The fixture retains its last setting for 2 minutes after the control signal is lost, after which it shuts off output.

Cycling power to the fixture before the 2 minutes have passed will clear the last look and the LEDs will remain off until control signal is restored.

HLL-4ever

Hold last look forever. After data is lost, the fixture maintains its last look until power is removed from the fixture or control signal is restored. The last look will not be restored after power has been cycled.

- 1: On the **DMX Settings** menu, scroll to **Data Loss**.

DMX Settings	
DMX Start Address:	101
DMX Profile:	HSIC
Strobe:	On
Data Loss:	Instant
Plus Seven:	On
Fan Mode:	DMX
2/15 Hue Fine	

Figure-4.7 Setting the Data Loss Type on the DMX Settings Menu

- 2: Press [**Enter**] to toggle through the three options.
- 3: Press [**▲▲▲**] or [**▼▼▼**] to commit the option.

Plus Seven (excluding Daylight and Tungsten)

Plus Seven allows enhanced color-mixing precision when using the RGB, HSI, HSIC, or Studio profile as a starting point for color selection. Enabling Plus Seven adds another 8 DMX channels of control at the end of the control channels already in use by the fixture. For example, in the HSIC profile, with Strobe enabled, the fixture uses 7 channels of control. Enabling Plus Seven adds another 8 channels to the fixture, for a total of 15 channels of control.

The first additional channel is an activation channel for the Plus Seven function. A value of 0 to 50% (DMX 0 to 129) deactivates Plus Seven. A value of 51 to 100% (DMX 130 to 255) activates Plus Seven. The remaining 7 additional channels correspond to the individual colors within the fixture's LED array.

- 1: On the **DMX Settings** menu, scroll to **Plus Seven**.

DMX Settings	
DMX Start Address:	101
DMX Profile:	HSIC
Strobe:	On
Data Loss:	Instant
Plus Seven:	On
Fan Mode:	DMX
1/15 Hue Coarse	

Figure-4.8 Enabling Plus Seven on the DMX Settings Menu

- 2: Press [**Enter**] to toggle between **On** and **Off**.
- 3: Press [**▲▲▲**] or [**▼▼▼**] to commit the option.

Using Plus Seven Control

- 1: On your lighting console, select a starting color point for the fixture output using the standard control channels for RGB, HSI, etc.
- 2: Set the first additional channel to a value between 51 and 100% to activate Plus Seven.
- 3: Refine the fixture output by altering one or more of the 7 individual color channels.
 - The starting point for each color is defined by the original color selection in step 1.
 - The brightness of each color can be increased or decreased from the starting point to any value between zero and full output.
 - Colors already at full output will not change when the Plus Seven channels are moved up from the starting point, and colors already at zero output will not change when the Plus Seven channels are moved down from the starting point.



Note: *Once any one of the seven individual color channels is altered from its neutral starting position, the settings for the original color point may no longer reflect the actual output of the fixture.*

When using RGB, HSI, HSIC, or Studio profile for color selection, each fixture makes accommodations for the specific LEDs in its array and produces output that is consistent with other fixtures, whether or not they use LEDs from the same production batch.

Operating with Plus Seven enabled can override this calibration, and multiple fixtures may produce slightly different outputs when individual color channels are altered from their neutral starting points.

Fan Control

Fan Control adds another DMX channel of control when set to DMX. Alternate settings are Slow, Fast, and Automatic. For more information, see [Fan Control](#) on [page 30](#).

- 1: On the DMX Settings menu, scroll to **Fan Mode**.

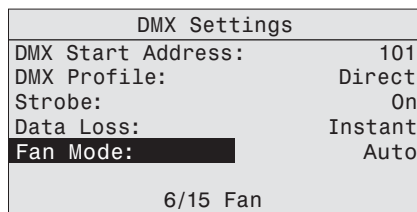

Figure-4.9 Setting the Fan Mode on the DMX Settings Menu

- 2: Press to scroll through the available options.
- 3: Press or to commit the option.

LED Settings

Use the LED Settings menu to adjust fixture performance. From the LED Settings menu, you can set the following:

- Output
- Curve
- Output Frequency
- Red Shift
- White Point



Figure-4.10 Selecting LED Settings on the Advanced Menu

Output

Use Output to choose the optimal balance between two competing performance parameters, maximum brightness and output consistency, by adjusting:

- How much the fixture limits the overall power to the LED array
- How the fixture reduces output as internal fixture components heat up during use or in high ambient temperatures

The output options are as follows.

Regulated

Regulated is a moderately constrained power or brightness with consistent output under typical use. Power to the LEDs is separately regulated in order to maintain consistent brightness during the initial fixture warm-up period. This is recommended for most indoor applications.

Protected

Protected provides the most consistent output possible with the greatest potential for reduced overall brightness. This is best for changing environmental temperatures, and applications with high requirements for consistency in extreme operating conditions.

Boost

Boost provides the brightest possible output, with least guarantee of consistency. This is best for applications with low duty cycles, loose brightness requirements, or where ambient temperature is low.

- 1: On the **Advanced Menu**, scroll to **LED Settings**.
- 2: Press [**Enter**].
- 3: With **Output** selected, press [**Enter**] to toggle between the options.
- 4: Press [**▲▲▲**] or [**▼▼▼**] to commit the option.



Note: *In all Output settings, if the fixture gets too warm and internal components approach unsafe operating temperatures, the total power to the LED array is gradually reduced and proportionate brightness levels between the various colors of LEDs are maintained as much as possible in order to preserve the overall color mix; however, some minor shifts in output may occur. Power continues to ramp down as much as necessary until internal fixture components return to a safe temperature. The fixture displays a warning message on the home screen indicating that power budgeting is in place, showing the percent of total power that is currently used.*

If the fixture exceeds its maximum internal temperature, the fixture enters a cool-down state, stops responding to the control signal, and it shuts down most or all power to the LED array and displays its over-temperature status according to its setting for over-temperature warning.

Curve

The dimming curve, commonly called curve, is the correlation between the change in the value of the dimming control signal and the actual change in the fixture's brightness. Curve is also the extent to which the fixture lags in its response time to the control signal in order to facilitate smoothness in dimming.

Standard

Standard is a modest curve for intuitive brightness changes at both high and low ends of the dimming range. Standard provides moderate lag in response for good smoothness. It allows quick jumps in brightness. Suitable for most applications.

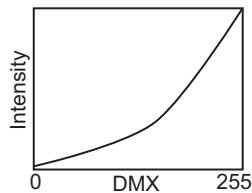

Incandescent

Exaggerated curve mimics the response of tungsten on a conventional dimmer. Lag is quite pronounced and present even in full on or off bumps. Extreme smoothness with no instant changes. Best when fixtures must operate in sync with incandescent sources.

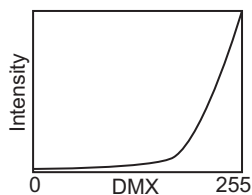

Linear

Linear has no curve. Brightness levels correlate exactly with the value of the dimming control signal. Moderate lag in response for good dimming smoothness. Linear allows quick jumps in brightness. It is best for studio lighting and applications with static scenes or looks.

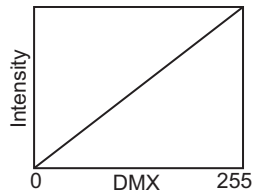

Quick

Quick uses the standard dimming curve but with no lag or smoothing. All changes are instant and correlated exactly with the control input signal. Quick is best for extreme high impact and video-based control.

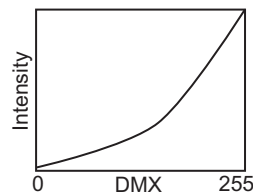

- 1: On the **LED Settings** menu, scroll to **Curve**.

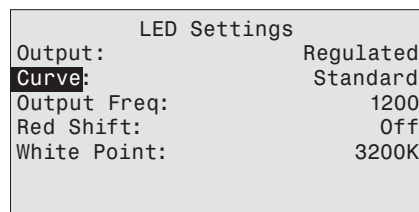

Figure-4.11 Selecting Curve on the LED Settings Menu

- 2: With **Curve** selected, press **[Enter]** to toggle between the options.
- 3: Press **[▲▲▲]** or **[▼▼▼]** to commit the option.

Output Freq

Output Frequency is the frequency in Hz at which the LED array pulses, or blinks, as a function of Pulse-Width Modulation (PWM). The frequency is adjustable in order to avoid visible flicker on video and film. When altering the frequency in order to reduce noticeable flicker on camera, often only a small change is required. The range is 920 to 1500 Hz in increments of 10. The default value is 1200 Hz.

For high speed exposure or rolling shutter cameras, use the High 25K mode. This increases the PWM to 25,000 Hz and will result in flicker-free operation in most circumstances. To access the High 25K, press the up arrow after reaching 1500 Hz in the Output Freq field.

Changing the frequency from the default value can have a slight impact on the smoothness, or color-mix consistency, or both when dimming.

- 1: On the **LED Settings** menu, scroll to **Output Freq**.

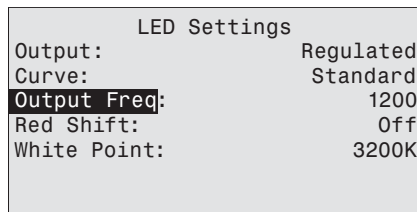

Figure-4.12 Selecting Output Frequency on the LED Settings Menu

- 2: Press [**Enter**] to select the value.
- 3: Press [**▲▲▲**] or [**▼▼▼**] to set the desired value.
- 4: Press [**Enter**].
- 5: When asked if you are sure, select **Yes** and press [**Enter**].

Red Shift

Red shift allows the fixture to match its dimming performance to that of a conventional tungsten lamp. The fixture automatically changes its apparent White Point, or color temperature, as a function of overall intensity. Red shift works with both white-light and colored-light output settings. It is also known as amber drift and tungsten shift. Red shift is available only in the HSI and RGB profiles. It is not available on Daylight and Tungsten fixtures.

- 1: On the **LED Settings** menu, scroll to **Red Shift**.

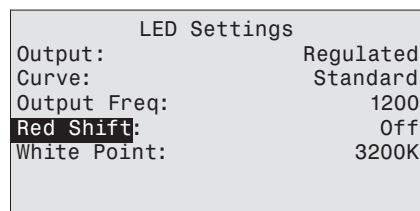

Figure-4.13 Selecting Red Shift on the LED Settings Menu

- 2: With **Red Shift** selected, press [**Enter**] to toggle between **On** and **Off**.
- 3: Press [**▲▲▲**] or [**▼▼▼**] to commit the option.

White Point (excluding Daylight and Tungsten)

White Point controls the appearance (color temperature) of white-light output when saturation is at or near zero. This option is available when using the HSI and RGB profiles. The choices are 2950K, 3200K, 5600K, and 6500K.

- 1: On the **LED Settings** menu, scroll to **White Point**.

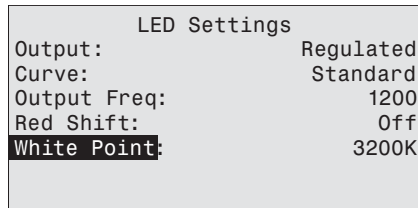

Figure-4.14 Selecting White Point on the LED Settings Menu.

- 2: With **White Point** selected, press **[Enter]** to toggle between the options.
- 3: Press **[▲▲▲]** or **[▼▼▼]** to commit the option.

Presets & Sequences

When no external control signal is connected to the fixture, the fixture can be set to run a preset color mix or a sequence of presets in a stand-alone operation. The fixture keeps the last preset or sequence active when power to the fixture is cycled on/off.

The Presets and Sequences screen provides access to the edit screens for Presets and for Sequences, and it indicates which Preset or Sequence is active, if any. You can access the Presets and Sequences menu by doing either of the following.

- On the **Advanced Menu**, scroll to **Presets & Sequences** and press **[Enter]**.
- From any menu, except when operating in Studio profile, press **[⚙️]**.



Figure-4.15 Selecting Presets & Sequences on the Advanced Menu

Focus

Focus is independent of any of the other settings or presets and works whether or not the fixture is receiving DMX data from a console or is in a Preset or stand-alone state. Focus stays on until you disable it or power is disconnected. It turns every LED in the fixture on at 70% so you can:

- Focus (aim) the fixture prior to console setup or when there is no one at the console to give the fixture intensity
 - Double-check that the fixture is working and that all LEDs are operational
- 1: From the **Advanced Menu** select **Presets & Sequences** or press **[⚙️]**.
 - 2: With **Focus** selected, press **[Enter]** to turn the fixture **On**.
 - 3: When finished, press **[Enter]** to turn the fixture **Off**.

Presets

About Presets (excluding Daylight and Tungsten)

A Preset is a single, static look or color mix. The Source Four LED Profile fixture comes with 24 default configurations. Only one Preset can be active at a time. You can activate any of the Preset color mixes and customize each one. The following table lists the default Preset color mixes, most of which are also available as Quick Color options. See [Quick Color \(excluding Daylight and Tungsten\)](#) on [page 60](#).

Preset	Default Color	Available as Quick Color
1	White	Yes
2	Warm	Yes
3	Cool	Yes
4	Minus Green	Yes
5	Lite Pink	Yes
6	Lite Gold	Yes
7	Yellow	Yes
8	Dark Straw	Yes
9	Dark Amber	Yes
10	Orange	Yes
11	Red	--
12	Med Pink	Yes
13	Dark Pink	Yes
14	Magenta	--
15	Purple	Yes
16	Dark Lavender	Yes
17	Deep Purple	Yes
18	Clear Blue	Yes
19	Lite Blue	Yes
20	Med Blue	Yes
21	Primary Blue	Yes
22	Blue-Green	Yes
23	Lite Green	Yes
24	Green	--

About Presets (Daylight and Tungsten only)

The Daylight and Tungsten fixtures come with 24 available slots for Presets. Only one Preset can be active at a time. You can activate any of the Presets and customize each one. Daylight and Tungsten fixtures have Presets that can define both Intensity and Strobe values. There are no default Presets that come pre-configured from the factory.



Figure-4.16 Selecting Presets on the Presets and Sequences Menu

- 1: On the **Presets and Sequences** menu, scroll to **Presets**.
- 2: Press **[Enter]**.
- 3: With **Preset** selected, press **[Enter]**.
- 4: Press **[▲▲▲]** or **[▼▼▼]** to set the desired preset number.
- 5: Press **[Enter]**.
- 6: Press **[▼▼▼]** to select **Status**.
- 7: Press **[Enter]** to activate the Preset.
The action changes to Active and an asterisk (*) displays in front of the preset number.



Note: *You cannot activate a Preset if the fixture is receiving an external DMX control signal.*

Fade Time

Fade time is the length of time the fixture takes to crossfade from the previous setting to the Preset. The format is MM:SS. The default is 2 seconds.

- 1: On the **Presets** menu, scroll to **Fade Time** and press **[Enter]**.

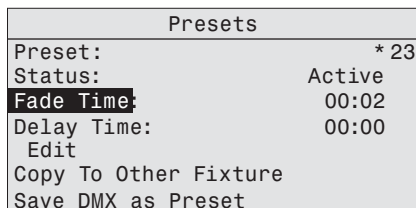

Figure-4.17 Selecting Fade Time on the Presets Menu

- 2: Press **[▲▲▲]** or **[▼▼▼]** to set the desired time in minutes.
- 3: Press **[Enter]**.
- 4: Press **[▲▲▲]** or **[▼▼▼]** to set the desired time in seconds.
- 5: Press **[Enter]**.

Delay Time

Delay time is the length of time the fixture waits on the previous setting before initiating the crossfade to the Preset. The default is 0 seconds.

- 1: On the **Presets** menu, scroll to **Delay Time** and press **[Enter]**.

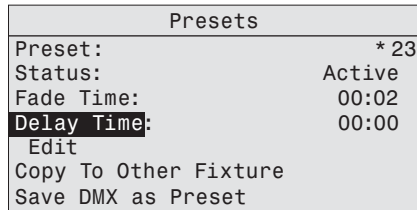

Presets	
Preset:	* 23
Status:	Active
Fade Time:	00:02
Delay Time:	00:00
Edit	
Copy To Other Fixture	
Save DMX as Preset	

Figure-4.18 Selecting Delay Time on the Presets Menu

- 2: Press **[▲▲▲]** or **[▼▼▼]** to set the desired time in minutes.
- 3: Press **[Enter]**.
- 4: Press **[▲▲]** or **[▼▼]** to set the desired time in seconds.
- 5: Press **[Enter]**.

Edit (excluding Daylight and Tungsten)

Use Edit to change the overall brightness settings of all colors within the LED array. You can change the predefined color mixes for the Preset. Refer to the table in [About Presets \(excluding Daylight and Tungsten\)](#) on [page 52](#). You can also change the hue, saturation, and intensity of the predefined colors.

To keep your changes, be sure to select **Save Changes** and then press **[Enter]**. To discard changes press **[<]** at any time.

If the Preset is currently active, the changes made on the Preset Color Edit screen update to the fixture output immediately.

- 1: On the **Presets** menu, scroll to **Edit** and press **[Enter]**.

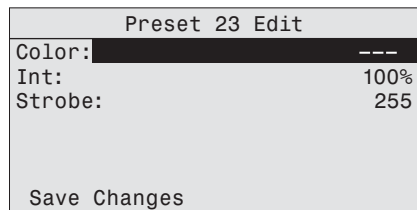

Preset 23 Edit	
Color:	---
Int:	100%
Strobe:	255
Save Changes	

Figure-4.19 Edit Preset Color Screen

- 2: With **Color** selected, press **[Enter]**.
- 3: Press **[▲▲▲]** or **[▼▼▼]** to set the desired predefined color mix.
- 4: Alternatively, to edit the predefined color mix, scroll to any of the parameters on the screen and press **[Enter]**.
- 5: Press **[▲▲]** or **[▼▼]** to change the values.
- 6: Press **[Enter]**.

- 7: Do one of the following:
 - Scroll to **Save Changes** and press [Enter].
 - Press [<] to exit the screen without saving the changes.

Edit (Daylight and Tungsten only)

Use Edit to change the brightness and strobe settings of the LED array.

To keep your changes, be sure to select **Save Changes** and then press [Enter]. To discard changes press [<] at any time.

If the Preset is currently active, the changes made on the Preset Edit screen update to the fixture output immediately.

- 1: On the **Presets** menu, scroll to **Edit** and press [Enter].

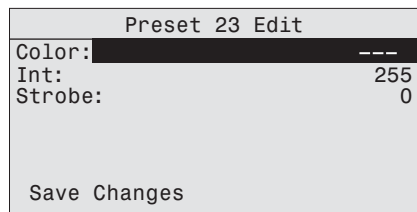

Figure-4.20 Edit Preset Screen

- 2: Scroll to any of the parameters on the screen and press [Enter].
- 3: Press [▲▲▲] or [▼▼▼] to change the values.
- 4: Press [Enter].
- 5: Do one of the following
 - Scroll to **Save Changes** and press [Enter].
 - Press [<] to exit the screen without saving the changes.

Copy to Other Fixtures

If other fixtures are connected to the same data chain, you can copy the Preset values to the other fixtures. The fixture automatically becomes the Master and controls all the other fixtures (Slaves) in the chain until another fixture has its Preset or Sequence settings selected or activated. For more information, see [Master/Slave Operation](#) on [page 61](#).

- 1: On the **Presets** screen, scroll to **Copy To Other Fixture**.

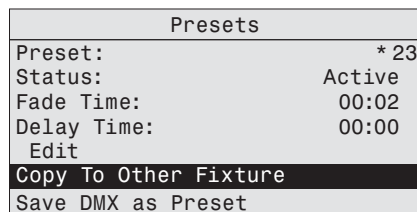

Figure-4.21 Copy to Other Fixture

- 2: Press [Enter].
- 3: When asked if you are sure, select **Yes** and press [Enter].

Save DMX as Preset

You can take a snapshot of the incoming DMX signal when the fixture is in HSI mode and save it as a preset value.

- 1: On the **Presets** screen, scroll to **Preset** and press [*Enter*].

Presets	
Preset:	* 23
Status:	Active
Fade Time:	00:02
Delay Time:	00:00
Edit	
Copy To Other Fixture	
Save DMX as Preset	

Figure-4.22 Save the DMX as a Preset

- 2: With **Preset** selected, press [*Enter*].
- 3: Press [*▲▲▲*] or [*▼▼▼*] to set the desired preset number.
- 4: Press [*Enter*].
- 5: Scroll to **Save DMX as Preset** and press [*Enter*].

Sequences

A Sequence is a timed series of presets. Up to 12 different Sequences may be altered for Preset selections, crossfade rate, and link time. Only one Preset can be active at a time. The sequences can be copied to other fixtures in the same data chain.

You can create your own custom sequence that includes two or more Presets. For example, you may want to sequence through Presets 2, 4, 23, and 1, in that order. As you enter these into the sequence, you also can set the rate and link time for each step.

Presets and Sequences	
Focus:	Off
Presets	
Sequences	
Quick Color	
Preset 1 is Active	
No Sequence is Active	

Enter

Sequences	
Sequence:	*3
Action:	Not Active
Rate:	100%
Step:	01
Preset:	1
Link Time:	00:02
Copy to Other Fixture	

Figure-4.23 Selecting Sequences on the Presets and Sequences Menu

- 1: From the **Advanced Menu** select **Presets & Sequences** or press [*⚙*].
- 2: On the **Presets and Sequences** menu, scroll to **Sequences**.
- 3: Press [*Enter*].
- 4: On the **Sequences** menu, with **Sequence** selected, press [*Enter*].
- 5: Press [*▲▲▲*] or [*▼▼▼*] to set the desired Sequence number.
- 6: Press [*Enter*].
- 7: Scroll to **Action**.
- 8: Press [*Enter*] to activate the Sequence.
The screen changes to Active and an asterisk (*) displays in front of the preset number.
- 9: Press [*▼▼▼*] to scroll to **Rate**.

Rate

Rate is the execution of the Presets' Fade Times and Delay Times within the Sequence, relative to their settings within the actual Presets. The available Rate range is 2 to 500%. The default is 100%.

A Rate of 100% represents running the Sequence with timing exactly as specified within the Presets. A Rate above 100% represents running the Sequence with faster timing than specified within the Presets. For example, with a Rate of 200%, a Preset with a Fade Time of 6 seconds would actually be run within the Sequence in only 3 seconds.

A Rate below 100% represents running the Sequence with slower timing than specified within the Presets. For example, with a Rate of 50%, a Preset with a Fade Time of 6 seconds would actually be run within the Sequence in 12 seconds.

Any change to the Rate is updated live in the fixture memory. Pressing [<] does not undo a change to Rate.

- 1: On the **Sequences** menu, scroll to **Rate** and press [Enter].

Sequences	
Sequence:	* 3
Action:	Not Active
Rate:	100%
Step:	01
Preset:	1
Link Time:	00:02
Copy to Other Fixture	

Figure-4.24 Selecting Rate on the Sequences Menu

- 2: Press [▲▲▲] or [▼▼▼] to set the desired percent.
- 3: Press [Enter].
- 4: Press [▼▼▼] to scroll to **Step**.

Step

You enter the number of the step in the sequence to be edited. In our example, you select step 1. After setting the Preset and Link time, return to **Step** and select step 2. Repeat this process until you have entered all the steps in the sequence.

Any change to Step is updated live in the fixture memory. Pressing [<] does not undo a change to Step.

- 1: On the **Sequences** menu, scroll to **Step** and press [Enter].

Sequences	
Sequence:	*3
Action:	Not Active
Rate:	100%
Step:	01
Preset:	1
Link Time:	00:02
Copy to Other Fixture	

Figure-4.25 Selecting Step on the Sequences Menu

- 2: Press [▲▲▲] or [▼▼▼] to set the desired Step number.
- 3: Press [Enter].
- 4: Press [▼▼▼] to scroll to **Preset**.

Preset

Preset is the number of a Preset, whether it is a predefined or a custom color mix.

- 1: On the **Sequences** menu, scroll to **Preset** and press [**Enter**].

Sequences	
Sequence:	*3
Action:	Not Active
Rate:	100%
Step:	01
Preset:	1
Link Time:	00:02
Copy to Other Fixture	

- 2: Press [**▲▲▲**] or [**▼▼▼**] to set the desired Preset number.
- 3: Press [**Enter**].
- 4: Press [**▼▼▼**] to scroll to **Link Time**.

Link Time

Link Time is the length of time the fixture waits before moving from one Preset to the next. The format is MM:SS. The default is 2 seconds.

- 1: On the **Sequences** menu, scroll to **Link Time** and press [**▼▼▼**].

Sequences	
Sequence:	*3
Action:	Not Active
Rate:	100%
Step:	01
Preset:	1
Link Time:	00:02
Copy to Other Fixture	

Figure-4.26 Selecting Link Time on the Sequences Menu

- 2: Press [**▲▲▲**] or [**▼▼▼**] to set the desired time in minutes.
- 3: Press [**Enter**].
- 4: Press [**▲▲▲**] or [**▼▼▼**] to set the desired time in seconds.
- 5: Press [**Enter**] to commit the values.

Finishing the Sequence

After each of the steps have been configured, set the End State. End state is what the fixture does once it completes the Sequence. Two end state options are available and both options repeat indefinitely until the Sequence is deactivated. To access the end state options, you must first program an additional and final step within the sequence using Preset 0. Preset 0 marks the end of the Sequence and opens the End State menu line. Preset 0 may only be used once within a Sequence. If you want the Sequence to repeat automatically, you may only define up to 23 steps with Presets 1 through 24, since the final step must be reserved for Preset 0.

- **Loop:** Once the fixture completes the entire sequence, it immediately returns to the beginning and starts the sequence over again, in order.
- **Bounce:** Once the fixture completes the entire sequence, it reverses the order of the presets and steps backward through them until reaching the starting step, at which point it starts the Sequence over again, in the original order.

Sequences	
Sequence:	* 3
Status:	Active
Rate:	100%
Step:	01
Preset:	0
End State:	Loop
Copy to Other Fixture	

Figure-4.27 Setting Sequences End State

- 1: On the **Sequences** menu, scroll to **Preset** and press **[Enter]**.
- 2: With the Preset number selected press **[▲▲▲]** or **[▼▼▼]** until you reach **0**.
- 3: Press **[Enter]**.
Link Time on the screen is replaced with End State.
- 4: Scroll to **End State** and press **[Enter]** to toggle between the options.
- 5: If the Sequence is not active, scroll up to **Action** and press **[Enter]**.

Copy to Other Fixtures

If other fixtures are connected to the same data chain, you can copy the Sequences settings to the other fixtures. The fixture automatically becomes the Master and controls all the other fixtures (Slaves) in the chain until another fixture has its Preset or Sequence settings selected or activated. For more information, see [Master/Slave Operation](#) on [page 61](#).

- 1: On the **Sequences** screen, scroll to **Copy to Other Fixture**.

Sequences	
Sequence:	* 3
Status:	Active
Rate:	100%
Step:	01
Preset:	0
End State:	Loop
Copy to Other Fixture	

Figure-4.28 Selecting Copy to Other Fixture

- 2: Press **[Enter]**.
- 3: When asked if you are sure, select **Yes** and press **[Enter]**.



Note: *This option only copies Sequence data; it does not copy changes to the Preset settings or color mixes used within the Sequence.*

Quick Color (excluding Daylight and Tungsten)

Quick Color allows you to easily select a color and its intensity from a predefined menu. This feature overrides any presets or sequences previously selected and is only available when there is no external DMX signal to the fixture. For a list of available colors, see the table on [page 52](#).



Note: *Exiting the Quick Color menu will return the fixture to the state it was in before entering the menu.*

- 1: Scroll to **Quick Color** within the **Presets and Sequences** screen.
- 2: Press

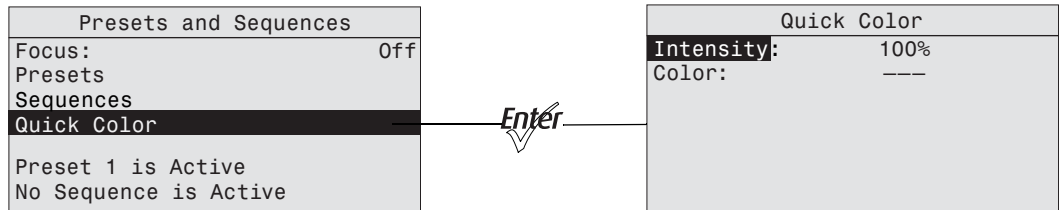

Figure-4.29 Selecting Quick Color on the Presets and Sequences Menu

- 3: Scroll to **Color** and press .
- 4: Press or to select the desired color
- 5: Press to commit the selection.
- 6: Scroll to **Intensity** and press .
- 7: Press and hold or to adjust the fixture's intensity.
- 8: Press to commit the selection.
 - To set the Intensity to 0, press the . Pressing a second time will return the fixture to its previously set Intensity.
 - If power to the fixture is lost while in Quick Color mode, the fixture will return to the Quick Color menu once power is restored.

Master/Slave Operation

When similar fixtures' DMX or data connections are linked together and there is no external DMX signal going to them, one fixture automatically controls all other fixtures in the chain when a Preset or Sequence is initiated.

Master

Master is the one fixture that controls all fixtures in the daisy chain. By default, it is whichever fixture had its Preset or Sequence selected or adjusted most recently. The Master fixture can only control Slave fixtures to produce identical output at the same time as itself. The Master fixture cannot control Slave fixtures to operate individually or to run chase-type or time-offset sequences.

Changes and edits to Presets or Sequences that are made to the Master fixture may be copied to the internal memory of all Slave fixtures for later use when these fixtures are disconnected from the data daisy chain.

When operating as the Master fixture, the fixture displays Master on its home screen.

```
Studio
-----
Studio Prt Lin -- Str
          Master
No Sequence is Active
Preset 1 is Active
          System OK
          1/5 Intensity
```

Figure-4.30 Master fixture displays Master on home screen

Slave

A slave is any fixture in the data chain that is being controlled by the master fixture. By default, all fixtures are slaves, except the one that had its Preset or Sequence altered most recently. A Slave fixture can only directly imitate the performance of the Master fixture.

When operating as a Slave fixture, the fixture displays Slave on its home screen.

Diagnostics

The Diagnostics menu provides access to detailed information about various aspects of the fixture's performance. Diagnostics also provides access to test functions and fixture recalibration. Much of the Diagnostics menu is used by service technicians to troubleshoot problems.

- 1: From the home screen, press [**Enter**] to open the **Main Menu**.
- 2: Scroll to **Advanced Settings**.
- 3: Press [**Enter**].

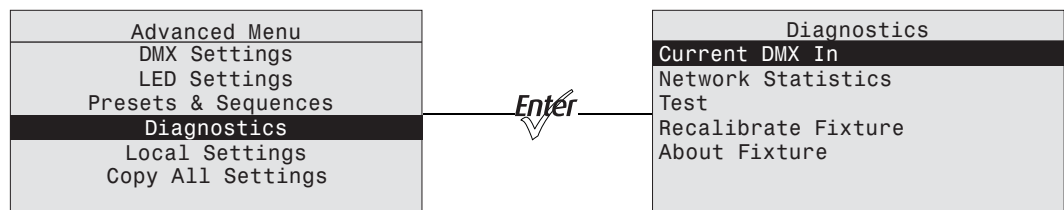

Figure-4.31 Selecting Diagnostics on the Advanced Menu

Current DMX In

The Current DMX In screen displays the values of the current DMX input by channels. The values dynamically change as the DMX input changes. This screen is a read-only screen, which displays the following:

- The Control Input setting
- The DMX channel assignment, in order
- The current DMX value (0-255) of each control channel in use by the fixture
- The current brightness (0 to full or 00 to FL) of each series of LEDs in the fixture's LED array

- 1: On the **Diagnostics** screen, scroll to **Current DMX In**.
- 2: Press **[Enter]**.

Current DMX In						
DMX Ch						Level
2						107
3						14
4						82
5						0
G	O	R	A	O	R	I
11	02	00	10	00	00	01

Figure-4.32 Current DMX In screen with dynamic values

- 3: Press **[▲▲▲]** or **[▼▼▼]** to scroll through the channels. Arrows on the left indicate that you can scroll up or down.
- 4: Press **[<]** to return to the Diagnostics screen.

Network Statistics

The Network Statistics screen displays the statistics of the network. The DMX input values dynamically change. This screen is read-only.

- 1: On the **Diagnostics** screen, scroll to **Network Statistics**.
- 2: Press **[Enter]**.
When you access the screen, the dynamic values start at 0 and continue to increase.

Diagnostics	
Network Statistics	
Overruns:	0
Received:	47835
Breaks:	15490
Bad Starts:	0
DMX Starts:	27120
RDM Starts:	0

Figure-4.33 Network Statistics screen with dynamic values

- 3: To reset the counters, press **[Enter]**.
- 4: Press **[<]** to return to the Diagnostics screen.

Test

Test is used to test the fixture and display its output values. Test overrides all other control to the fixture. The action options are All Off, All On, Chase, and Ind Cntl (Individual control). The default is All Off.

To exit the Test screen, press [<] twice. The fixture will revert to its previous state.

- 1: On the **Diagnostics** screen, scroll to **Test**.
- 2: Press [Enter].

Diagnostics						
Test						
Action:		Chase			Chase	
Chase:		15 steps/sec				
Individual Control						
G	O	R	A	O	R	I
00	00	48	00	00	00	00

Figure-4.34 Test Screen in Chase mode

- 3: With **Action** selected, press [Enter] to toggle between the options.
- 4: Press [▲▲▲] or [▼▼▼] to commit the option.



Chase

Chase automatically sequences through each LED color and starts each at 0% intensity and steps up to 100% before moving to the next color. You can set the number of steps per second for sequencing through all LED colors individually.

- 1: On the **Test** screen, scroll to **Action**.
- 2: Press [Enter] until the **Chase** option displays.
The fixture begins to sequence through the LEDs.
- 3: Press [▼▼▼] to select **Chase**.
- 4: Press [Enter] to select the values.
- 5: Press [▲▲▲] or [▼▼▼] to set the number of steps per second.
The range is 10 to 20.
- 6: Press [Enter] to commit the value.
The percent of intensity is displayed for each color as the fixture sequences through them.
- 7: To stop the test, do one of the following:
 - Press [▲▲▲] or [▼▼▼] to select **Action** and then press [Enter] until **All Off** displays.
 - Press [<] to return to **Action** and then press [Enter] until **All Off** displays.





Individual Control (Ind Cntr)

Use Individual Control to select each LED series and then adjust its intensity.

- 1: On the **Test** screen, scroll to **Action**.
- 2: Press  until the **Ind Cntr** option displays.
One of the LED series will illuminate.
- 3: Press  to select the series.

Diagnostics						
Test						
Action:						Ind Cntr
Chase:						15 steps/sec
Individual Control						
G	O	R	A	O	R	I
56	00	00	00	00	00	00

Figure-4.35 Test Screen in Individual Control mode

- 4: Press  or  to set the intensity of the series.
- 5: Press  to move to the next series.
The value you entered for the first series is applied to the next series.
- 6: Press  or  to change the intensity of the series.
- 7: Press [<] to return to **Action**.

Recalibrate Fixture

Service technicians may use this option to calibrate the constant current driver electronics for the LEDs. The calibration process goes through each series of LEDs, starting at 0% intensity and stepping up to 100%. The calibration is automatic and takes a few minutes. During this time, do not exit the screen until it is complete.



CAUTION: *This calibration process does not measure or recalibrate the light output of the LEDs.*

Under normal use, it is not necessary to recalibrate the fixture, and doing so will likely have no beneficial effect on fixture performance. It is therefore NOT recommended to recalibrate the fixture without express instruction from an authorized technician.



- 1: On the **Diagnostics** screen, scroll to **Recalibrate Fixture**.
- 2: Press .
- 3: When asked if you are sure, select **Yes** and press .



Figure-4.36 LED Calibration screen with calibration in process

- 4: Press  or [<] to return to the **Diagnostics** screen.



About Fixture

The About screen displays the following information. This is a read-only screen.

- The software version number
- The fixture serial number
- The assigned fixture RDM number
- The color bias of the LED array

About Fixture	
DMX Start:	001
Ver:	1.8.0.9.0.13 (1)
Ser:	000021xxx
RDM:	6574:12345678
S4 Ser2 Lustr	
RDM Label	

Figure-4.37 About Fixture screen



- 1: On the **Diagnostics** screen, scroll to **About Fixture**.
- 2: Press .
- 3: Press  or [<] to return to the **Diagnostics** screen.

Local Settings

The Local Settings menu gives you several options that affect the LCD and other functions of the fixture.







Figure-4.38 Selecting Local Settings on the Advanced Menu

- 1: On the **Advanced Menu**, scroll to **Local Settings**.
- 2: Press .
- 3: Scroll to any of the menu choices and press .

Backlight

You can change the brightness of the LCD backlight. The brightness level is 10 to 100%. The default is 100%.

- 1: With **Backlight** selected, press  to select the value.
- 2: Press  or  to set the desired brightness percentage. The effect can be seen as you make the adjustment.
- 3: Press .

BLght time out

You can change the length of time the LCD backlight remains on after a UI button has been pressed. The options are 30 seconds, 1 minute, 5 minutes, 15 minutes, and never. The default is 1 minute.

- 1: With **BLght time out** selected, press **[Enter]**.

Local Settings	
Backlight:	100%
BLght time out:	1 min
Language:	English
Status Indicators:	Off
OverTemp:	Visible
Restore Defaults	

Figure-4.39 Setting backlight timeout

- 2: Continue to press **[Enter]** until the desired time is indicated.
- 3: Press **[▲▲▲]** or **[▼▼▼]** to commit the option.

Language

English is used for all menus. No other languages are offered at this time.

Local Settings	
Backlight:	100%
BLght time out:	1 min
Language:	English
Status Indicators:	Off
OverTemp:	Visible
Restore Defaults	

Figure-4.40 Setting the screen language

Status Indicators

You can turn the status indicators on or off. The default is on.

- 1: With **Status Indicators** selected, press **[Enter]**.

Local Settings	
Backlight:	100%
BLght time out:	1 min
Language:	English
Status Indicators:	Off
OverTemp:	Visible
Restore Defaults	

Figure-4.41 Setting the Status Indicator display

- 2: Continue to press **[Enter]** to toggle between ON and OFF.
- 3: Press **[▲▲▲]** or **[▼▼▼]** to commit the option.



Note: *When set to OFF, Status Indicators will turn off after the backlight timeout period.*



CAUTION: *Although it may be desirable in some applications to eliminate all stray light from the back of the fixture, turning the Status Indicators OFF prevents them from communicating potentially critical information. Use discretion when selecting the OFF setting.*

OverTemp

You can change how an over-temperature situation is indicated in order to control stray light.

Visible (excluding Daylight and Tungsten)

The fixture produces a low-level red light from the LED array, displays a warning message on the LCD, turns on the LCD backlight, and turns on the error indicator light.

Visible (Daylight and Tungsten only)

The fixture produces a low-level light from only some of the LEDs in the LED array, displays a warning message on the LCD, turns on the LCD backlight, and turns on the error indicator light.

Dark

The fixture turns off the LED array entirely and displays a warning message on the LCD without turning on the LCD backlight.

- 1: With **OverTemp** selected, press **[Enter]**.

Local Settings	
Backlight:	100%
BLght time out:	1min
Language:	English
Status Indicators:	Off
OverTemp:	Visible
Restore Defaults	

Figure-4.42 Setting over temperature indication

- 2: Continue to press **[Enter]** to toggle between the two options.
- 3: Press **[▲▲▲]** or **[▼▼▼]** to commit the option.

For more information, see [Thermal Shutdown Warning](#) on [page 41](#).



Note: *When returning to normal operation, after the fixture has been in a shutdown status, the LED array automatically transitions its output back to the current control signal or stand-alone operation over a 10-second crossfade. There is no required reset function once the fixture temperature returns to a safe level.*

Restore Defaults

You can restore the fixture to the factory settings. This function clears all custom settings including all changes to Presets and Sequences.

- 1: With **Restore Defaults** selected, press **[Enter]**.
- 2: When asked if you are sure, select **Yes** and press **[Enter]**.
- 3: Press **[Enter]**.

Copy All Settings

When DMX is not applied you can copy all settings, except DMX address, to all of the other fixtures in the same data chain in one step. This includes everything from Presets and Sequences to Quick Setups and Advanced options.

This feature is not available when DMX is applied to the fixture.

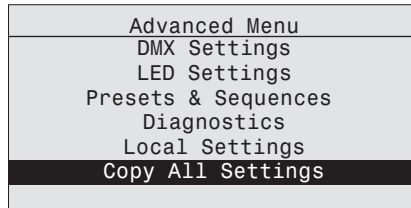

Figure-4.43 Copy All Settings on the Advanced Menu

- 1: With **Copy All Settings** selected, press [Enter].
- 2: When asked if you are sure, select **Yes** and press [Enter].
- 3: Press [Enter].

Studio Settings

All Fixtures Except Daylight and Tungsten

The Studio profile produces only white light that is adjustable in brightness, white point, and tint (green/magenta balance). The Studio profile can be operated in a stand-alone mode from the user interface or can be controlled via DMX.



Note: *Studio profile is the default Quick Setup for fixtures containing the Studio HD LED array. Fixtures with other LED arrays may also be operated in Studio profile by selecting this setting from Quick Setups or DMX Settings. Fixtures with Studio HD LED arrays may also be operated in other setups.*

Operation From Home Status Screen (Studio Stand-alone)

When operating without an external control signal, the intensity of the white light can be adjusted immediately and directly by pressing the UI buttons on the fixture while on the home screen. In this setup, all the UI buttons change their functions from other setups. Icons on the screen indicate which buttons to use for the settings.

When fixtures are connected together and there is no control signal, all adjustments that you make on one fixture are automatically made on the connected fixtures.

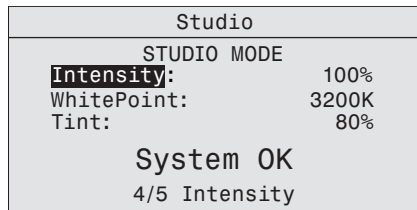

Figure-4.44 Studio Status Home screen (all fixtures except Daylight and Tungsten)

- To adjust the Intensity, select it in the menu and press [Enter] and then [▲▲▲] or [▼▼▼]. The range is 0 to 100%.
- To immediately set the Intensity to 0, press the [☼] button. Pressing it again will return it to the previously-set Intensity.
- To adjust the White Point, select it in the menu and press [Enter] and then [▲▲▲] or [▼▼▼]. The range is 2700 to 6500K.
- To adjust the Tint, select it in the menu and press [Enter] and then [▲▲▲] or [▼▼▼]. Pressing [▲▲▲] increases magenta and [▼▼▼] increases green.
- To return to the Main Menu, press [<].
- To return to the Studio status screen from the Main Menu, press [<<].

Studio DMX Control

When controlled via DMX, the first three channels adjust the output in the following order. Channel 5 controls strobe.

Channel	Output
1	Intensity (Brightness)
2	White Point
3	Tint
5	Strobe

When adjusting white point via DMX, the full gamut of 2725 to 6450K is available, but common settings of 3200K and 5600K are quickly accessible at the lowest and highest pairs of DMX values, respectively. The range of control on channel 2 is distributed as follows.

DMX Value	White Point
000 to 001	3200K
002 to 253	Adjustment from 2725 to 6450K
254 to 255	5600K

When adjusting tint via DMX, the range of control on channel 3 is distributed as follows.

DMX Value	Tint
000 to 001	Neutral white (at the specified white point)
002 to 127	Full plus-green to neutral white
128	Neutral white
129 to 255	Neutral white to full minus-green (full magenta)

Additional channels for other functions, such as strobe and Plus Seven, can also be activated, if desired, starting with channel 4.



Note: *When using DMX to control the fixture in Studio mode, the default data-loss behavior is different than in other operational modes. If the DMX signal is lost, the fixture automatically holds the last look forever (HLL-4ever). This look persists through infinite off/on power cycles until the DMX signal is restored or the fixture settings are adjusted manually via the user interface.*

When powering down the fixture in Studio mode, continue to supply DMX to the fixture until after the fixture has powered down. If you power down the fixture before the fixture has finished saving the last look, the fixture may return to default settings when powered up again instead of holding the last look.

Daylight and Tungsten only

The Studio profile allows quick adjustment of Intensity. The Studio profile can be operated in a stand-alone mode from the user interface or can be controlled via DMX.

Operation From Home Status Screen (Studio Stand-alone)

When operating without an external control signal, the quality of the white light can be adjusted immediately and directly by pressing the UI buttons on the fixture while on the home screen. In this setup, all the UI buttons change their functions from other setups. Icons on the screen indicate which buttons to use for the settings.

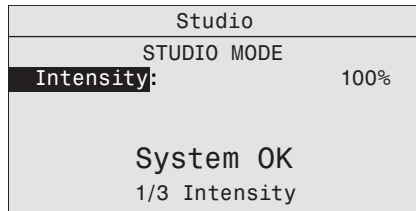

Figure-4.45 Studio Status Home screen.

- To adjust the **Intensity**, press [**Enter**] and then [**▲▲▲**] or [**▼▼▼**]. The range is 0 to 100%.
- To return to the Main Menu, press [**<<**].
- To return to the Studio status screen, from the Main Menu, press [**<<**], [**<**], or allow the user interface to time out and automatically return to the status screen.

Studio DMX Control

When controlled via DMX, the channels adjust the following.

Channel	Output
1	Intensity (Brightness)
2	Strobe
3	Fan

Error Messages

When a system error is detected, a message displays on the home screen. The message changes to reflect the specific error type. When multiple errors are detected, each error message cycles, in increasing numerical order on the display for 1 second each. The following table lists the error messages.

Error Message	Description
LED Ambient Overtemp	The LED head ambient temp is too hot and has been shut down, let fixture cool down
LED Ambient High	The LED head ambient temperature is getting hot. Let the fixture cool.
LED Ambient Low	The LED head ambient temperature is too cold. Improper operating conditions.
Color System Fail	Fixture does not have its color information loaded. Most likely represents a hardware failure. Contact ETC Technical Services.
LED Over Temp	A specific LED is too hot and the fixture has been shut down.
Internal Temp High	Fixture internal temperature is too hot.
Power Budget Active	The fixture is reducing the LED output due to hot temperatures.
Internal Overtemp	The internal temperature is too hot, so the fixture has been shut down. Let the fixture cool.
Configuration Error	The stored configuration has been compromised. The fixture will return to a default configuration.

Software Updates

The software can be updated with ETC's UpdaterAtor Software. UpdaterAtor allows you to remotely update the Source Four LED fixture. UpdaterAtor is installed on your computer and connected from the computer to the fixture with a special cable. For more information, contact ETC's Technical service department. For specific ETC contact information, see [Contacts](#) on [page 6](#).

Routine Maintenance

To ensure optimum performance of your Source Four LED Profile fixture, you should perform the following inspections and cleaning at least once a year. You may need to inspect or clean the fixture more often, depending on the type and amount of use your fixture experiences during the year.



WARNING: Allow fixture to cool down completely prior to cleaning.

Disconnect all power and DMX cables prior to cleaning.

Check for excessive dust or debris in the heat-dissipating fins around the entire fixture enclosure. Clean using compressed air or a soft cloth. Keeping the components of the enclosure clean facilitates efficient cooling and extends LED longevity.

NEVER spray liquids into the fixture.

NEVER spray compressed air into a fixture that is powered-up.

Cleaning the Field Lens

The field lens is accessed by removing the shutter barrel from the light engine body.

Use a clean micro-fiber cloth to clean the lens. Isopropyl alcohol may be used on the cloth. Do not spray the cleaning solution directly onto the lens or the interior of the fixture.

- 1: Remove the retainer bolt and lens rotation knob.

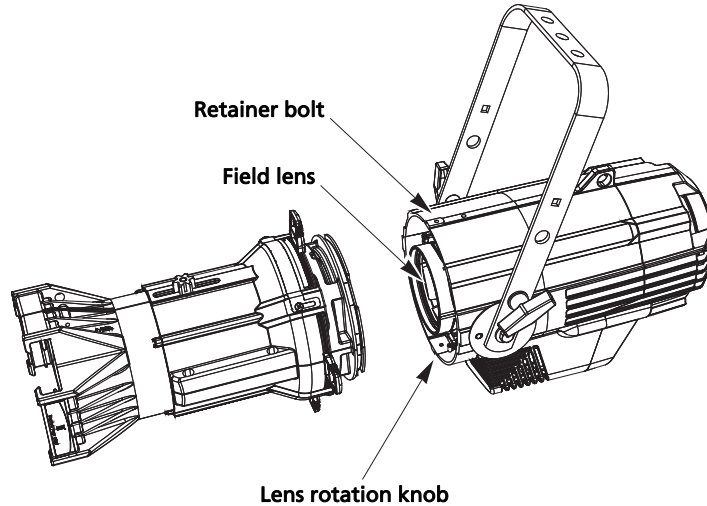

Figure-4.46 Removing the shutter barrel to expose the field lens

- 2: Slide the electronics and lens out of the fixture.
- 3: Use a clean, soft cloth as described above to clean the lens.



Note: *Do not remove the field lens from the electronics or attempt to disassemble the field lens. The lens or electronics contain no serviceable parts.*

- 4: Install and tighten the retainer bolt and lens rotation knob.

Inspecting and Cleaning the Electronics

- ❑ A can of compressed air or oil-free air from an air compressor set at a low setting can be used to blow through the vent holes and remove dust or other debris from the interior of the fixture. Dust buildup can cause overheating and premature shutdown.
 - ❑ Remove the secondary lenses (if used) and clean out any dust and debris. All components, including the secondary lenses, can be cleaned using compressed, oil-free air as described above or a clean micro-fiber cloth. Isopropyl alcohol may be used.
 - ❑ Inspect all mounting hardware for wear and, if necessary, clean using compressed, oil-free air or a soft, lint-free cloth.
- 1: Use a 5/32" hex driver to remove the two screws that secure the back of the electronics to the housing.

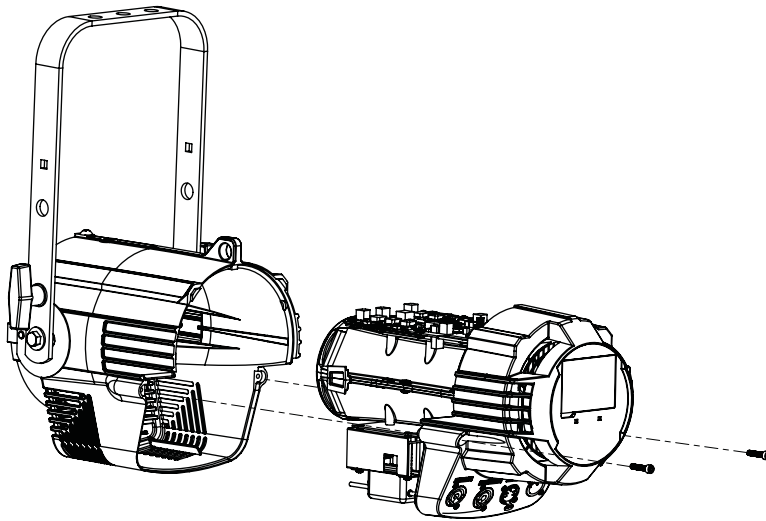

Figure-4.47 Electronics pulled out of housing

- 2: Slide the electronics and lens assembly out of the housing.



Note: *Do not remove the field lens from the electronics or attempt to disassemble the field lens. The lens contains no serviceable parts.*

- 3: While the electronic component body is separated from the housing, visually inspect the interior of the body and ensure there is no dust buildup on the components. If there is, use canned compressed air or oil-free air from an air compressor set at a low setting to remove dust or other debris from the interior of the fixture.
- 4: To reassemble, align the mating grooves in the shutter barrel with the clips on the electronics assembly and join the two.
- 5: Install and tighten the hex head screws.

Appendix A

Menu Flow Chart

The following illustrations show each of the menus that are displayed on the Source Four LED fixture LCD and the path to each one.

Home and Main Menus (Excluding Daylight and Tungsten)

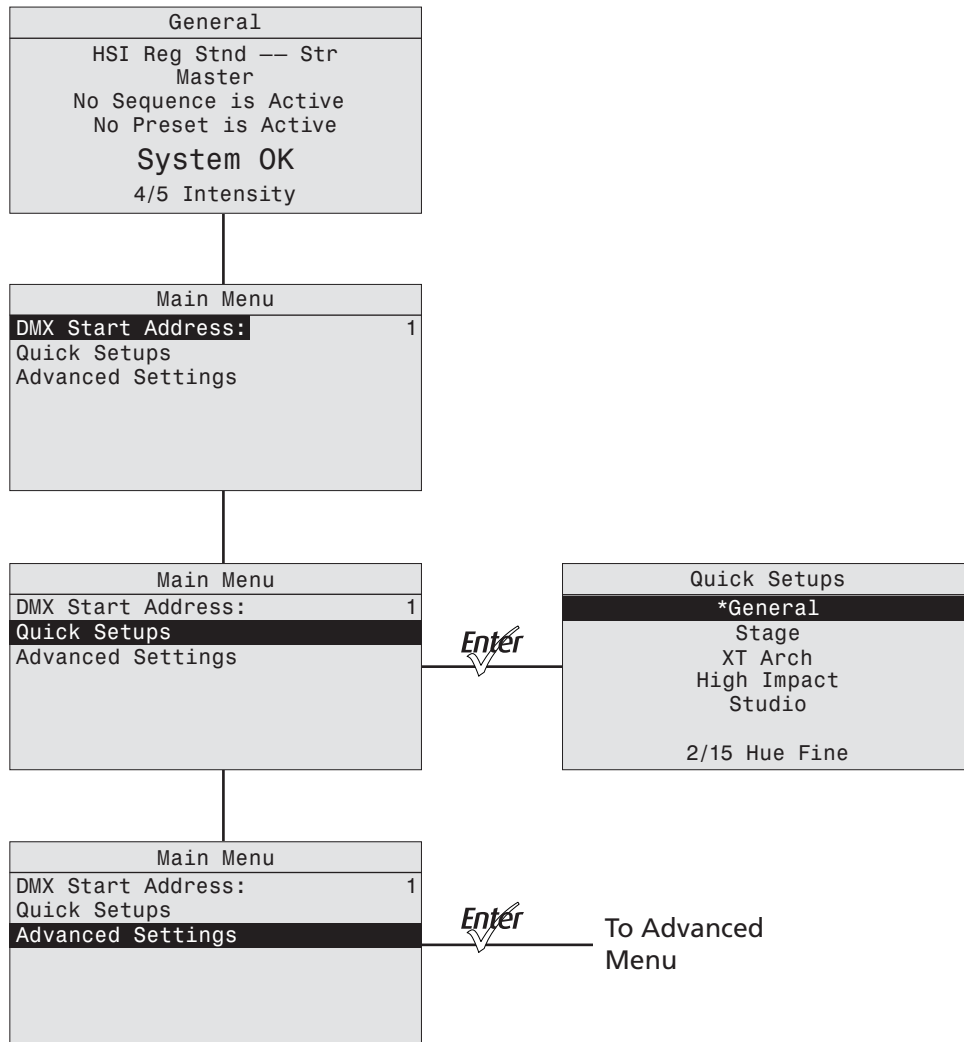

Home and Main Menus (Daylight and Tungsten Only)

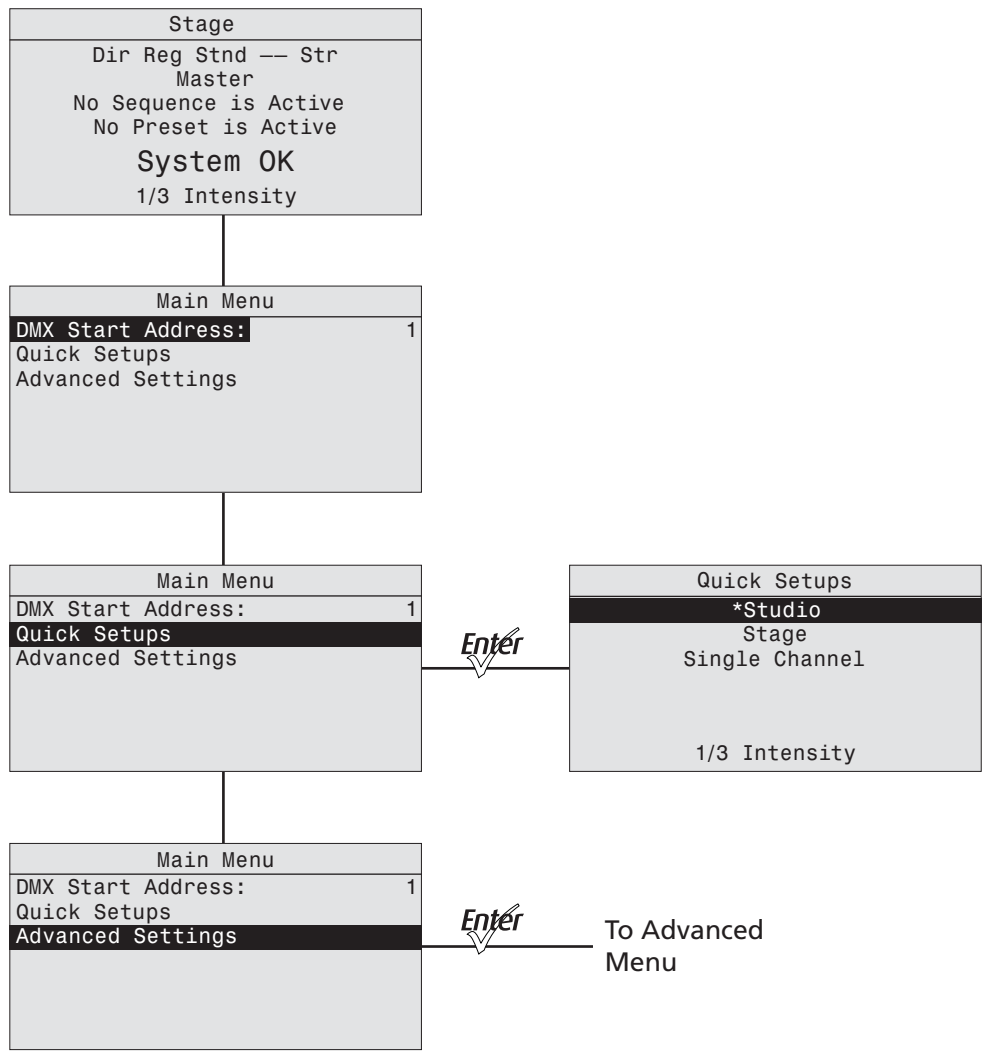

Advanced Menu (Daylight and Tungsten Only)

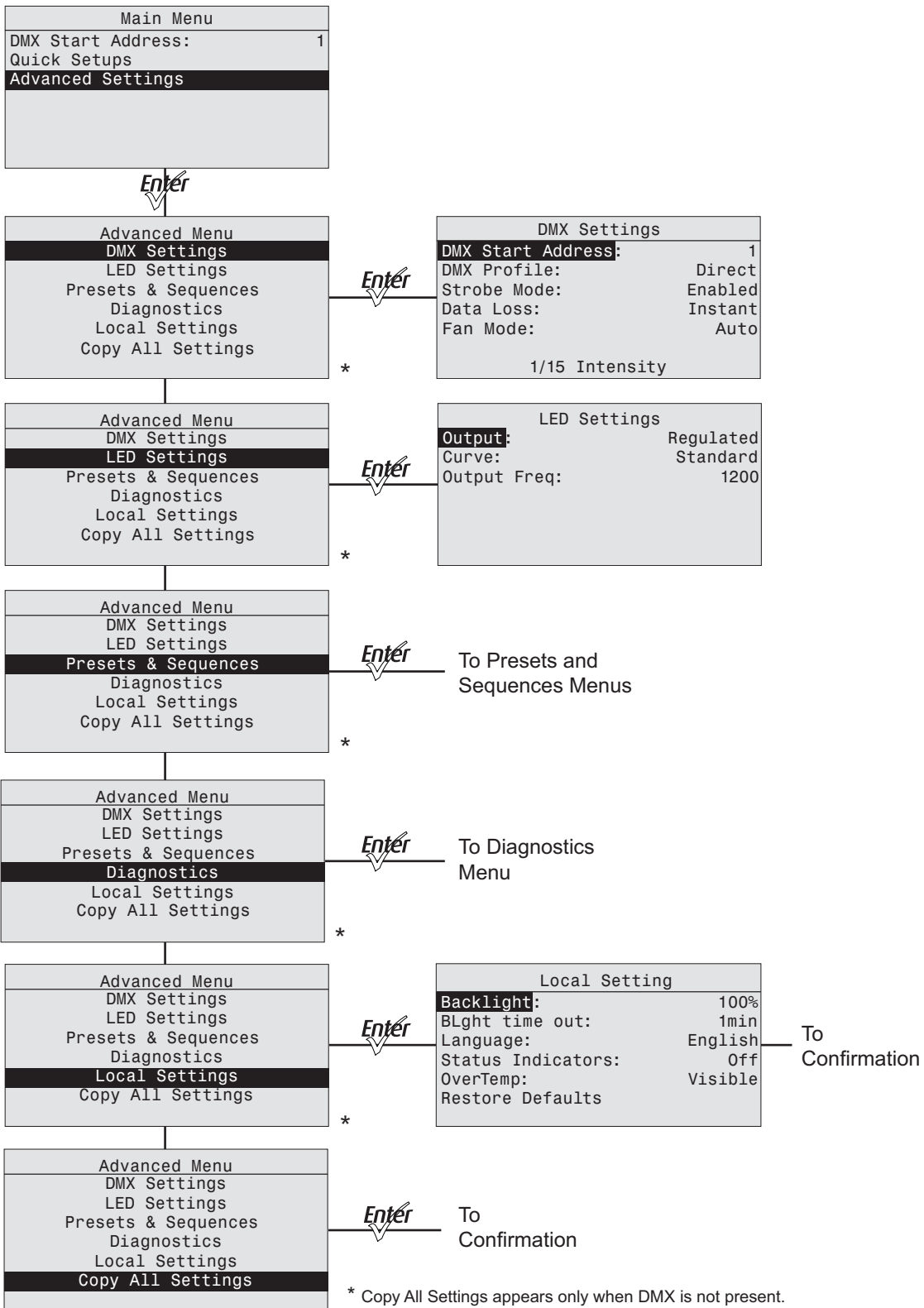

Presets Menu (Excluding Daylight and Tungsten)

* Copy All Settings appears only when DMX is not present.

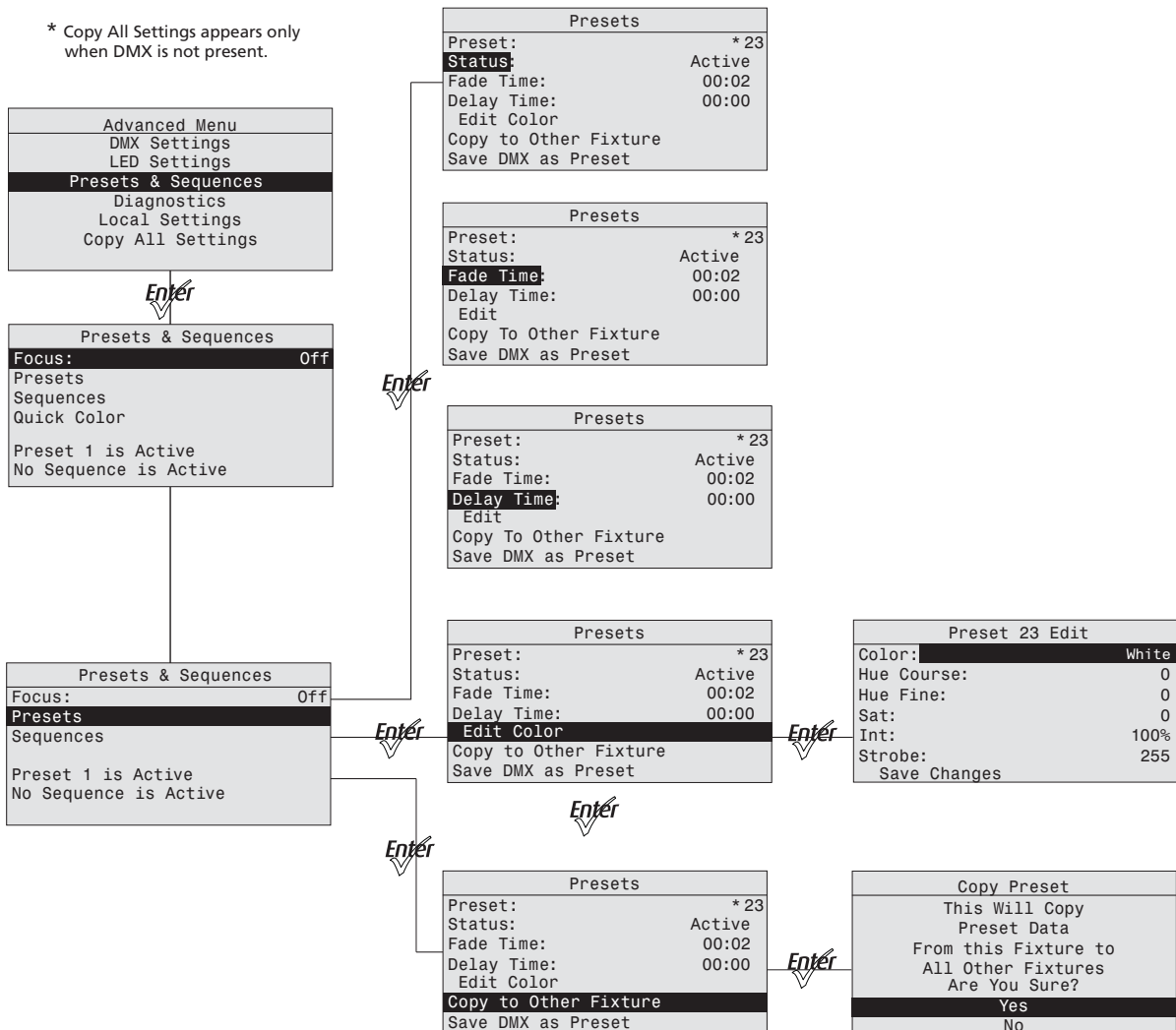

Presets Menu (Daylight and Tungsten Only)

Advanced Menu
DMX Settings
LED Settings
Presets & Sequences
Diagnostics
Local Settings
Copy All Settings

Enter

Presets & Sequences	
Focus:	Off
Presets	
Sequences	
Preset 1 is Active	
No Sequence is Active	

Presets & Sequences	
Focus:	Off
Presets	
Sequences	
Preset 1 is Active	
No Sequence is Active	

Presets	
Preset:	* 23
Status:	Active
Fade Time:	00:02
Delay Time:	00:00
Edit Color	
Copy to Other Fixture	
Save DMX as Preset	

Presets	
Preset:	* 23
Status:	Active
Fade Time:	00:02
Delay Time:	00:00
Edit	
Copy To Other Fixture	
Save DMX as Preset	

Presets	
Preset:	* 23
Status:	Active
Fade Time:	00:02
Delay Time:	00:00
Edit	
Copy To Other Fixture	
Save DMX as Preset	

* Copy All Settings appears only when DMX is not present.

Presets	
Preset:	* 23
Status:	Active
Fade Time:	00:02
Delay Time:	00:00
Edit	
Copy to Other Fixture	
Save DMX as Preset	

Enter

Preset 23 Edit	
Preset:	23
Int:	100%
Strobe:	0
Save Changes	

Presets	
Preset:	* 23
Status:	Active
Fade Time:	00:02
Delay Time:	00:00
Edit Color	
Copy to Other Fixture	
Save DMX as Preset	

Enter

Copy Preset	
This Will Copy Preset Data	
From this Fixture to All Other Fixtures	
Are You Sure?	
Yes	
No	

Sequences Menu and Quick Color Menu



Note: The Quick Color Menu is not available in Daylight or Tungsten Fixtures

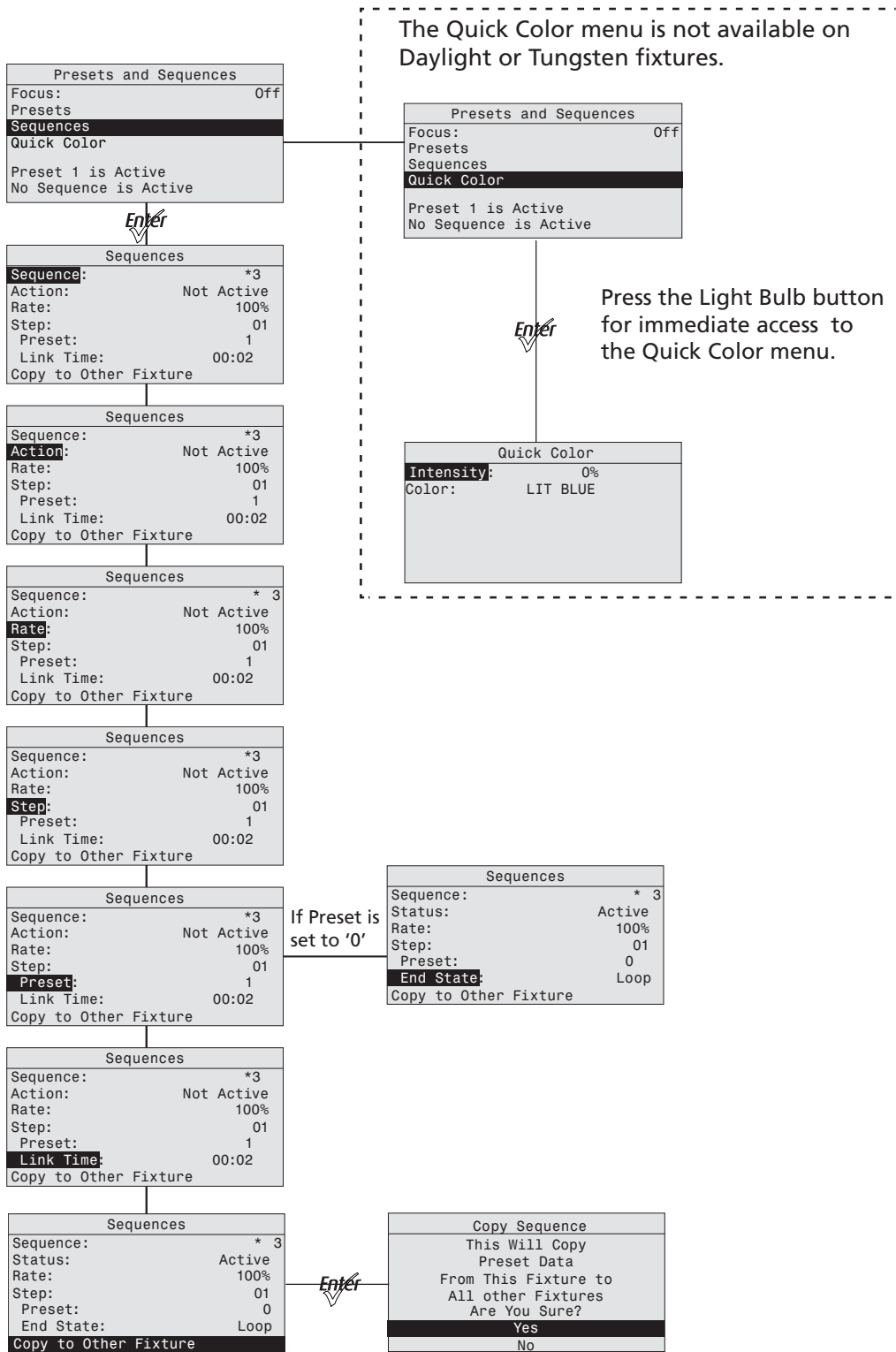

Diagnostics Menu

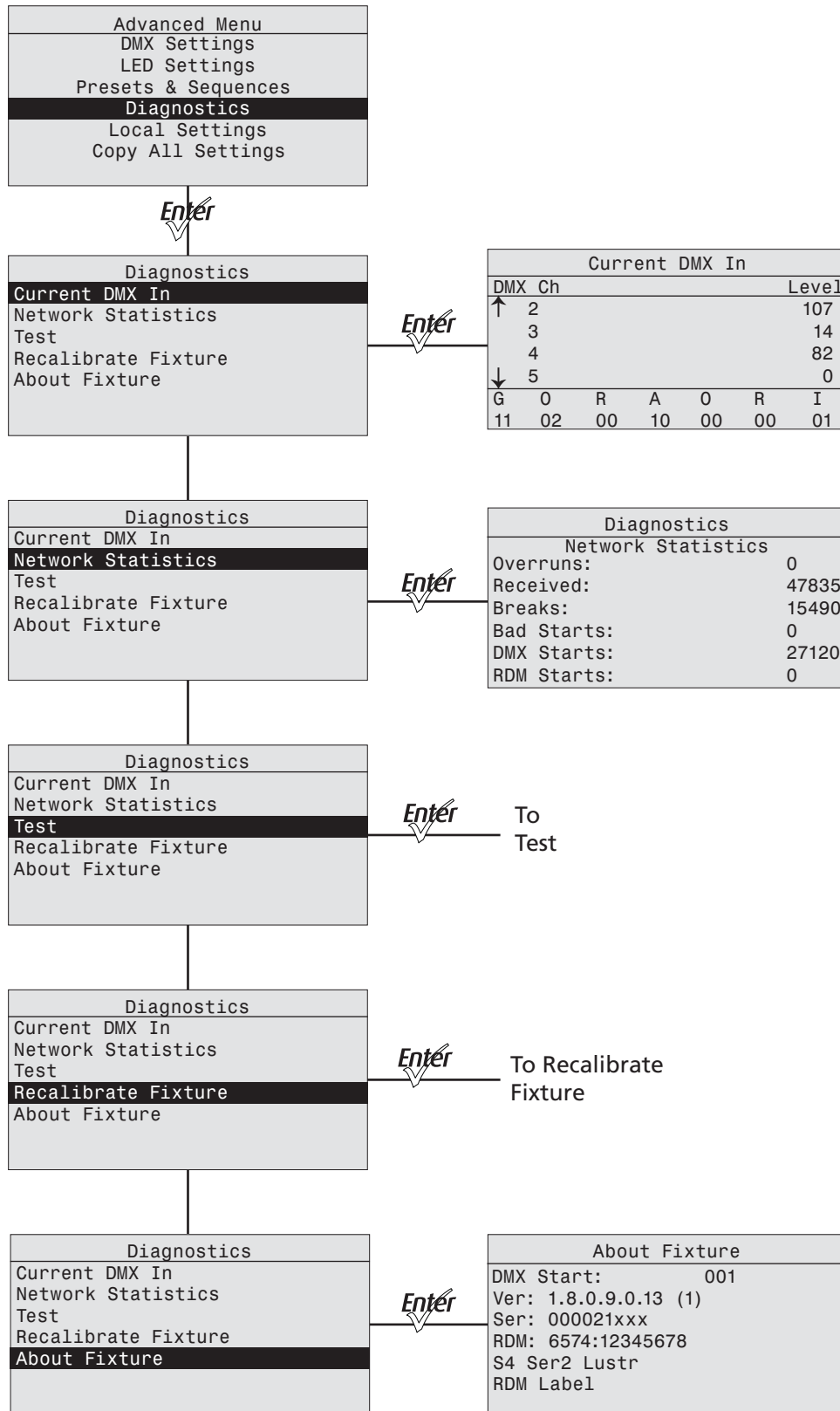

Diagnostics Test

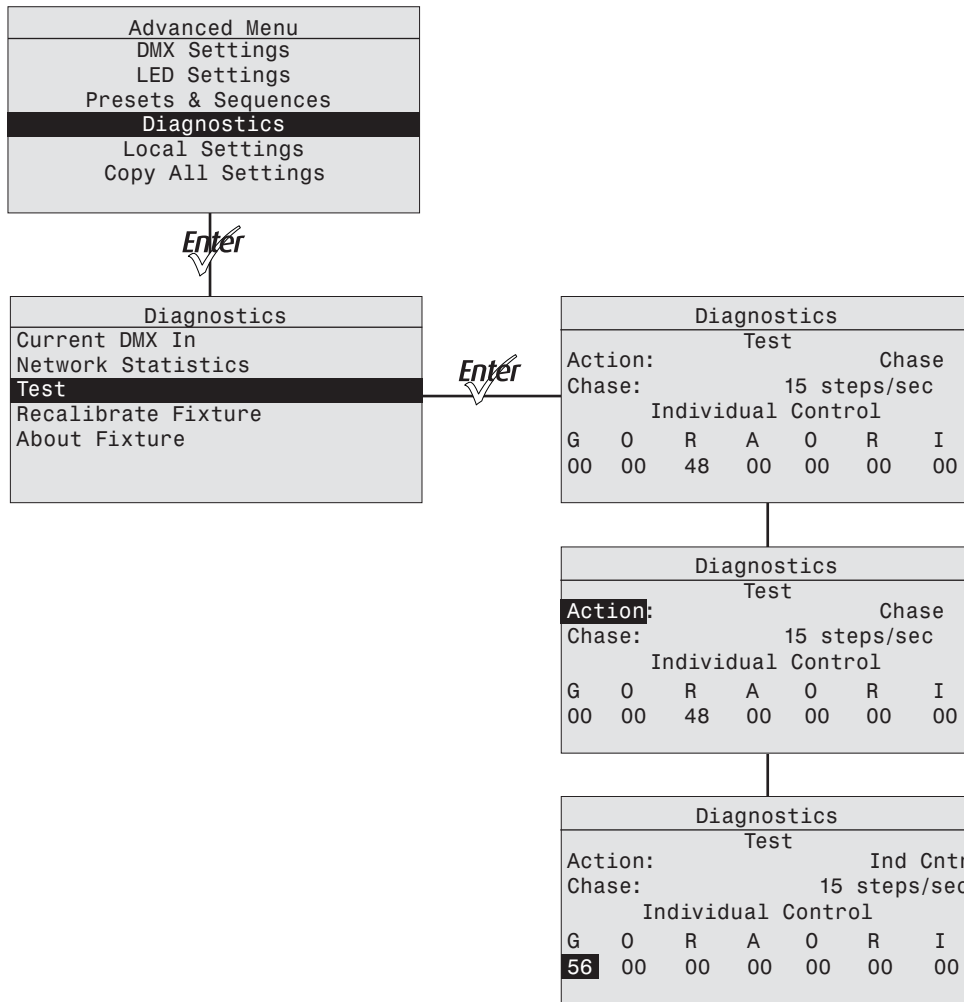

Diagnostics Recalibrate Fixture

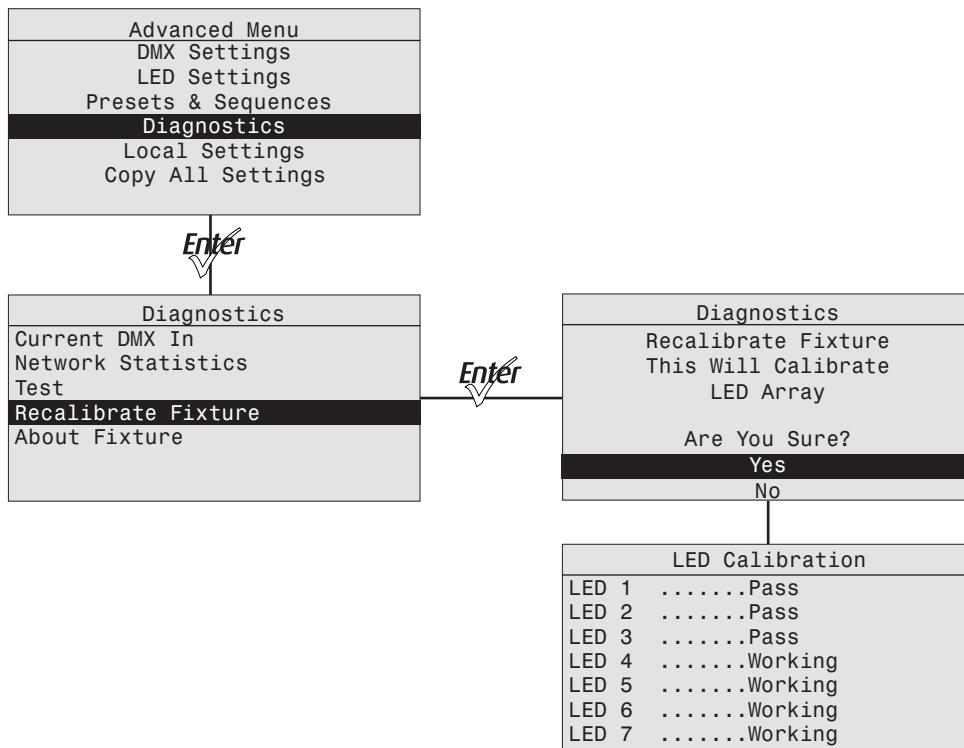



Corporate Headquarters ■ Middleton, WI, USA ■ Tel +608 831 4116 ■ Service: (Americas) service@etconnect.com

London, UK ■ Tel +44 (0)20 8896 1000 ■ Service: (UK) service@etceurope.com

Rome, IT ■ Tel +39 (06) 32 111 683 ■ Service: (UK) service@etceurope.com

Holzkirchen, DE ■ Tel +49 (80 24) 47 00-0 ■ Service: (DE) techserv-hoki@etconnect.com

Hong Kong ■ Tel +852 2799 1220 ■ Service: (Asia) service@etcasia.com

Web: etconnect.com ■ © 2018 Electronic Theatre Controls, Inc.

Product information and specifications subject to change. ETC intends this document to be provided in its entirety.

7460M1200-1.8.0 ■ Rev J ■ Released 2018-05